

DELO

SCELTI PER TE

CATALOGO
LISTINO N°8
2024



IL MARCHIO



Grazie alla collaborazione tra gli associati, il Gruppo Delfino ha potuto sviluppare un proprio marchio, **Delò®** che:

- è una selezione di prodotti e marche, il risultato della migliore scelta che un operatore o un utilizzatore finale può fare;
- è il frutto dello studio di un **team specializzato nel settore** che analizza le vendite, la soddisfazione degli utenti e opera quotidianamente con i più affidabili produttori italiani;
- mette a disposizione solo prodotti sottoposti ad una **lunga selezione** che tiene conto degli standard qualitativi del produttore, delle esigenze del cliente finale e dell'idraulico che deve installare il prodotto;
- offre prodotti e soluzioni per durare nel tempo proponendo il miglior prezzo per i livelli di **qualità desiderata nei diversi segmenti di offerta;**
- è una gamma che viene costantemente aggiornata e rinnovata per migliorare anche singoli dettagli tecnici ed estetici;
- si può trovare **solo (ed esclusivamente) dai rivenditori associati Delfino;**
- garantisce che tutte le sue soluzioni ottemperino alle normative vigenti in termini di certificazioni, assicurazioni di prodotto e rispetto per l'ambiente.

Il Gruppo Delfino, proprietario del brand **Delò®**, è anche **Corporate Golden Donor del FAI - Fondo Ambiente Italiano.**



UN GRUPPO ITALIANO STORICO



Il **Gruppo Delfino** è un consorzio di 55 grossisti dell'idrotermosanitario presenti con punti vendita e show-room di proprietà su gran parte del territorio italiano.

Fondato nel **1976**, rappresenta una delle prime aggregazioni di imprese che si è costituito in forma di società cooperativa senza scopo di lucro, struttura che ha permesso a Delfino di impegnarsi in progetti con impatto sociale.

Il Gruppo oggi è una rete nazionale che mette in condivisione esperienze, prodotti, soluzioni e conoscenze tecniche per dare ai propri grossisti associati un valore unico e distintivo da offrire ai loro clienti siano essi professionisti o privati.

ELENCO ASSOCIATE AL GRUPPO DELFINO

REGIONE	SOCIETÀ	INDIRIZZO - CITTÀ	Telefono - E-mail
PIEMONTE	CITAB Soc Coop	Via Cavour, 114 13894 Gaglianico (BI)	Tel. 015.58.21.001 - 015.58.21.329 info@citab.it - www.citab.it
	Filiale: FORNITURE TERMOIDRAULICHE Srl	Via Quintino Sella, 19 13854 Quaregna Cerreto (BI)	Tel. 015.33.55.445 - info@fornituretermoidrauliche.eu www.fornituretermoidrauliche.eu
	CI ESSE Srl	Via Novara, 274 28021 Borgomanero (NO)	Tel. 0322.81.614 info@ciesse.biz - www.ciesse.biz
	BORGOTERMICA Sas	Via Cuneo, 52/E 12011 Borgo San Dalmazzo (CN)	Tel. 0171.26.62.21 borgotermica15@gmail.com - www.borgotermica.it
	Filiale "BORGOSTUFE"	Corso Barale, 103 12011 Borgo San Dalmazzo (CN)	Tel. 0171.26.39.01 borgostufe@gmail.com - www.borgostufe.it
	A.B.C.D. Srl	Via De Amicis, 81 10093 Collegno (TO)	011.40.35.070 abcd@abcdsrl.it - www.abcdsrl.it
LOMBARDIA	COIMA Srl	Via Varese, 19 21046 Malnate (VA)	Tel. 0332.42.85.84 coima@coimasrl.it - www.coimasrl.it
	IDROMARKET LAVENO Srl	Via Arioli, 15 21014 Laveno Mombello (VA)	Tel. 0332.66.65.87 - info@idromarket-laveno.it www.idromarket-laveno.it
	Show Room	Via Arioli, 1 21014 Laveno Mombello (VA)	Tel. 0332.66.65.87 expo@idromarket-laveno.it
	IL PIACERE Srl	Via Tre Corsi, snc 21046 Malnate (VA)	Tel. 0332.42.68.02 info@ilpiacere.net - www.ilpiacere.net
	Show Room	Viale Kennedy, 45 21046 Malnate (VA)	Tel. 0332.42.68.02
	Filiale il PIACERE.ch	Via Michele Roggia, 2 CP 19 6853 Mendrisio-Ligornetto (TI) - CH	Tel. 0041.91.646.07.36 info@ilpiacere.ch - www.ilpiacere.ch
	FOTIR Srl	Via Damiano Chiesa, 2 21057 Olgiate Olona (VA)	Tel. 0331.37.53.00 info@fotir.it - www.fotir.it
	Show Room "KERDUSA"		Tel. 0331.68.52.45 kerdusa@fotir.it
	Filiale	Via Ronchetti, 909 21044 Cavaria Con Premezzo (VA)	Tel. 0331.21.73.89 cavaria@fotir.it
	Filiale "LA SARACINESCA"	Via C.I. Frugoni, 7 20162 Milano (MI)	Tel. 02.66.10.40.37 lasaracinesca@fotir.it
	IDROSANITARIA Sas di Sala G. e C.	Via Della Pergola, 48/50 23900 Lecco (LC)	Tel. 0341.36.45.40 info@idrosanitarialecco.net - www.idrosanitarialecco.net
	EREDI PIANTONI Srl	Via Sottoprovinciale, 1/4 24021 Albino (BG)	Tel. 035.77.34.05 info@piontoni.it - www.piontoni.it
	CIEFFE DI CAPELLI Srl	Via Angelo Giotti, 16 24018 Villa D'Almè (BG)	Tel. 035.54.10.68 info@cieffecapelli.it - www.cieffecapelli.it
	R.I.S.A.B. Srl	Via Sacco e Vanzetti, 7 20081 Abbiategrasso (MI)	Tel. 02.94.96.22.77 info@risab.it - www.risab.it
	Filiale	Corso Milano, 52 27029 Vigevano (PV)	Tel. 0381.64.58.59 info.vigevano@risab.it
	VIRES Srl	Via Messina, 99 20831 Seregno (MB)	Tel. 0362.32.66.72 vendite@viressrl.it - www.viressrl.it
MONTAGNA Srl	Via Amendola, 98 27058 Voghera (PV)	Tel. 0383.36.66.50 info@montagnaweb.com - www.montagnaweb.com	
LA SANITARIA PAVESE Srl	Via P. Bianchi, 57 27049 Stradella (PV)	Tel. 0385.49.917 - 0385.42.501 lasanitariapavese@gmail.com	
TRENTINO ALTO ADIGE	IDROFORNITURE Srl	Via Campo sportivo, 28 38023 Cles (TN)	Tel. 0463.62.52.62 info@idroforniture.it - www.idroforniture.it
	Deposito	Viale De Gasperi, 112/23 38023 Cles (TN)	Tel. 0463.62.52.62
	Deposito	Via Alto Adige, 138 38121 Trento (TN)	Tel. 0436.62.52.62
FRIULI VENEZIA GIULIA	LORENZO OTTOGALLI Sas	Via Crosere, 126 33053 Latisana (UD)	Tel. 0431.52.06.61 info@ottogalli.com - www.ottogalli.com
	Filiale	Via Adriano Olivetti, 40/42 33059 Fiumicello Villa Vicentina (UD)	Tel. 0431.96.554 filiale@ottogalli.com
	EDILNORDUE - TERMCO Srl	Via Moimacco, 1 33043 Cividale Del Friuli (UD)	Tel. 0432.73.32.73 info@edilnorduetermco.it - www.edilnorduetermco.it
LIGURIA	S.I.R.E.A. Srl di Repetto A. & C.	Via Bontà, 95 16043 Chiavari (GE)	Tel. 0185.31.02.31 alessandro@sireasrl.it - www.sireasrl.com
	Show Room	Corso Garibaldi, 13 16043 Chiavari (GE)	Tel. 0185.02.21.86 info.expo@sireasrl.com
	PATTONO Srl	Via Filippo Casoni, 46/R 16143 Genova (GE)	Tel. 010.51.17.41 info@pattono.com - www.pattono.com
	ANDREETTO Srl	Via Benessea, 15 17035 Cisano Sul Neva (SV)	Tel. 0182.59.50.14 info@andreetto.com - www.andreetto.com

REGIONE	SOCIETÀ	INDIRIZZO - CITTÀ	Telefono - E-mail
VENETO	STEMA Srl	Via Castellana, 28 35010 Trebaseleghe (PD)	Tel. 049.93.85.238 info@stema-gasparini.it - www.stema-gasparini.it
	TOMASELLA RINALDO GROUP Srl	Via Manin, 187 31015 Conegliano (TV)	Tel. 0438.45.05.73 acquisti@tomasellagroup.it - www.tomasellagroup.it
	Show Room	Viale Italia, 109 31015 Conegliano (TV)	Tel. 0438.62.817 v.italia@tomasellagroup.it
	IDRO-COMM Srl	Via E. Fermi, 15 36066 Sandrigo (VI)	Tel. 0444.65.87.58 info@idrocomm.net - www.idrocomm.net
	Filiale	Via Volta, 15 31020 Villorba (TV)	Tel. 0422.77.79.15 filialetreviso@idrocomm.net
	TECNOTERMO Srl	Via Gioberti, 26 A/B 30038 Spinea (VE)	Tel. 041.54.12.155 info@tecnotermo.biz - www.tecnotermo.biz
	Show Room		Tel. 041.54.12.155 arredobagno@tecnotermo.biz
EMILIA ROMAGNA	ACQUAPROGETTI Srl	Viale del Lavoro, 5 45100 Rovigo (RO)	Tel. 0425.19.01.991 info@acquaprogetti.it - www.acquaprogetti.it
	AQUAPLANTSYSTEM Srl	Via Papa Luciani, 22/23 32020 Limana (BL)	Tel. 0437.96.73.87 limana@aquaplantsystem.it
	Show Room		Tel. 324.56.44.145 expo@aquaplantsystem.it
	Filiale	Via Culiada, 18 32032 Feltre (BL)	Tel. 327.23.76.647 feltre@aquaplantsystem.it
	CORBELLINI FERRAMENTA E IDRAULICA Srl	Via Benedetta, 155/A 43122 Parma (PR)	Tel. 0521.77.99.11 info@corbellini.it - www.corbellini.it
	Show Room		Tel. 0521.77.99.14 - 0521.77.99.17 mostrabagno@corbellini.it
	IDROMARKET Srl	Via Statale Sud, 58 41037 Mirandola (MO)	Tel. 0535.61.04.90 info@idromarket.com
Show Room		Tel. 0535.61.05.02	
MARCHE	FATIS Srl	Via Ettore Majorana, 1 41012 Carpi (MO)	Tel. 059.68.20.20 info@fatiscarpi.it - www.fatiscarpi.it
	PANTERMO Sas di Guiati Barbara, Roberto & C.	Via Cento, 74/C 40017 San Giovanni in Persiceto (BO)	Tel. 051.82.30.02 pantermo@libero.it - www.pantermo.it
	I.S.A.F Linea Bagno Srl	Via Balzella, 71/B 47122 Forlì (FC)	Tel. 0543.72.03.91 - 0543.72.45.65 isaf@isaflineabagno.it
	ARTURO MANCINI Srl	Via Nazario Sauro, 18 47841 Cattolica (RN)	Tel. 0541.96.10.05 succ.cattolica@arturomancini.it
	Show Room		Tel. 0541.83.49.62 - 0541.83.49.65 mostra.ca@arturomancini.it
MARCHE	ARTURO MANCINI Srl	Via Gagarin, 23 61122 Pesaro (PU)	Tel. 0721.42.11 - 0721.42.12.01 info@arturomancini.it - www.arturomancini.it
	Show Room		Tel. 0721.42.12.13 - 0721.42.12.46 mostra.ps@arturomancini.it
	Filiale	Via Della Pineta, 21/A 61032 Fano (PU)	Tel. 0721.82.47.64 - 0721.82.73.55 succ.fano@arturomancini.it
	Show Room	Via Montegrappa, 5 61032 Fano (PU)	Tel. 0721.82.06.34 - 0721.89.71.97 arredobagno.fano@arturomancini.it
TOSCANA	BONCI Srl	Via A. Merloni, snc - Z.I. Taccoli 62027 San Severino Marche (MC)	Tel. 0733.64.50.50 info@fratellibonci.it - www.fratellibonci.it
	AQUA.COM Spa	Via G. Gozzano, 157/161 51100 Sant'Agostino (PT)	Tel. 0573.53.20.32 info@aquacom.it - www.aquacom.it
	Filiale	Via S. Donato, 31 50127 Firenze (FI)	Tel. 055.07.34.246 luigi.spinelli@aquacom.it
	IDROPLAST di Del Corso M. e P. & C. Snc	Via Luigi Bianchi, 86 56123 Pisa (PI)	Tel. 050.54.02.89 mario@idroplast.net - www.idroplastitalia.com
	Show Room	Via Luigi Bianchi, 94 56123 Pisa (PI)	Tel. 050.54.02.89 info@idroplast.net
	Filiale e Show Room	Via Aurelia Nord, 8 56122 Pisa (PI)	Tel. 050.52.54.51 vendite.aurelia@idroplast.net
	Filiale e Show Room	Via Galileo Ferraris, 4 57124 Livorno (LI)	Tel. 0586.86.35.85 vendite.livorno@idroplast.net
	VALLATI Srl	Via Cellane, 9B 58033 Castel del Piano (GR)	Tel. 0564.95.56.90 - 0564.95.74.37 termoidraulica@vallati.com - www.vallati.com
	Show Room		Tel. 0564.95.76.99 salamostra@vallati.com
Show Room	Via San Michele, 578/584 53025 Piancastagnaio (SI)	Tel. 0577.78.66.84 salamostra@vallati.com	
THERMOIGIENICA Srl	Via G. D'Annunzio, 215 Loc. Querceta - 55047 Seravezza (LU)	Tel. 0584.76.81.52 thermoigienicasrl@gmail.com - www.thermoigienica.it	

ELENCO ASSOCIATE AL GRUPPO DELFINO

REGIONE	SOCIETÀ	INDIRIZZO - CITTÀ	Telefono - E-mail
UMBRIA	ESSECCI Srl	Via L. Da Vinci, 6 06068 Tavernelle di Panicale (PG)	Tel. 075.83.27.28 - 075.83.27.15 info@essecci.net - www.essecci.net
	Filiale	Viale Umbria, 27/B 06063 Magione (PG)	Tel. 075.84.72.432 magione@essecci.net
	EDILCERAMICA EUGUBINA Srl	Via della Piaggiola, 184 06024 Gubbio (PG)	Tel. 075.92.72.611 info@edilceramicaeugubina.it - www.edilceramicaeugubina.it
ABRUZZO	EURO COFIR Srl	Via Val Di Foro, 97 66010 Villamagna (CH)	Tel. 0871.30.10.16 eurocofir@virgilio.it
	DI MONTE Srl	Via Masciangelo, 35 66034 Lanciano (CH)	Tel. 0872.42.54.5 dimontesrl@libero.it
	Show Room "DI MONTE DESIGN"		Tel. 0872.42.54.5 info@dimontedesign.it - www.dimontedesign.it
LAZIO	TERMOIDRAULICA COMMERCIALE CAIVIT Srl	Via Duilio Mainella, 10/12 01100 Viterbo (VT)	Tel. 0761.25.11.44 info@tccspa.it - www.caivit.it
	Show room "TCC Ti Crea Casa"		Tel. 0761.27.06.60 info@tccviterbo.it - www.tccviterbo.it
	TERMOSABINA Srl	Via G. Matteotti, 156 - Passo Corese 02032 Fara in Sabina (RI)	Tel. 0765.48.71.14 info@termosabina.it - www.termosabina.it
	ALFANI CERAMICHE Srl	Via Aurelia Km. 44,300 00052 Cerveteri (RM)	Tel. 06.99.03.303 - 308 admin@alfaniceramiche.it - www.alfaniceramiche.it
	Filiale	Via Dei Lecci, 137 00062 Bracciano (RM)	Tel. 06.99.81.54.95 termo@alfaniceramiche.it
CAMPANIA	Filiale	Viale Guido Bacelli, 127/129/133 00053 Civitavecchia (RM)	Tel. 0766.73.22.25 civitavecchia@alfaniceramiche.it
	Filiale	Via Roma, 60 C/D 00055 Ladispoli (RM)	Tel. 06.31.05.36.65 ladispoli@alfaniceramiche.it
	GDL Srl DI LEONE	Via M. Mattei, 20 82032 Cerreto Sannita (BN)	Tel. 0824.86.11.22 idraulica@dileone.it- www.dileone.it
	Show Room		pavimenti@dileone.it
	CEMI Srl	Via Rivolta, 73 80040 Striano (NA)	Tel. 081.82.77.414 cemistriano@libero.it- www.cemistriano.it
PUGLIA	Sede legale	Via Gaetano Nunziante, 30 84087 Samo (SA)	
	CERIALE Srl	Via Difesa Maddalena Inferiore, 2 84022 Campagna (SA)	Tel. 082.84.43.03 simone@ceriale.srl - www.cerialsrl.it
	CLARK Srl	Zona Industriale 73052 - Parabita (LE)	Tel. 0833.59.30.59 info@clarksrl.it - www.clarksrl.it
	SPAM di Sansaro C. & C. Sas	S.P.130 Trani-Andria Km.1,200 76125 Trani (BT)	Tel. 0883.50.24.90 sansaro@spamtrani.it - www.spamtrani.it
BASILICATA	Filiale	P.zza Martiri di Via Fani, 6 76125 Trani (BT)	Tel. 0883.50.10.03 sansaro@spamtrani.it
	Show Room	Via P. Capano, 19 76125 Trani (BT)	Tel. 0883.50.84.47 sansaro@spamtrani.it
CALABRIA	IDROPLAST Srl	Contrada La Vaglia, 36/BIS 75100 Matera (MT)	Tel. 0835.33.66.05 idroplastsrlmt@gmail.com- www.idroplastmatera.it
	BR TERMITALIA Srl	Via Savutano, 106/D1 88046 Lamezia Terme (CZ)	Tel. 0968.43.10.20 info@brtermitalia.it- www.brtermitalia.it
SICILIA	CENTRO TERMOIDRAULICO LEUZZI Srl	Via Taranto, 12 89034 Bovalino (RC)	Tel. 0964.67.00.44 giovanni.leuzzi72@libero.it - www.termoidraulicagl.it
	MATERIALE EDILE TERZO di Nicola Marchese & C. Snc	Via G. Evangelista Di Blasi, 173/E 90135 Palermo (PA)	Tel. 091.40.02.50 nicola.marchese@terzoweb.com - www.terzoweb.com
SARDEGNA	Show Room "54B STUDIO CO.WORK"	Via Della Libertà, 54 90135 Palermo (PA)	Tel. 091.84.37.669 lorenzo.marchese@terzoweb.com
	TERMOIDRAULICA DI ROBERTO PUSCEDDU	Z.I. Sinnai, sn - Loc. Luceri 09048 Sinnai (CA)	Tel. 070.78.93.84 info@termoidraulicasinnai.it

I FORNITORI PARTNERS DELO'



RUBINETTERIA CROMATA	RUBINETTERIA INOX 316		18	
	RUBINETTERIA BAGNO		20	
	FILTRAZIONE ACQUA POTABILE		47	
	RUBINETTERIA CUCINA		52	
	RUBINETTERIA LEVA CLINICA		59	
	RICAMBI RUBINETTERIA		60	
LINEA DOCCIA	INOX 316	78	SET DOCCIA	115
	TERMOSTATICI E MISCELATORI	83	PRESE ACQUA	116
	COLONNE DOCCIA	88	SUPPORTI DOCCIA	118
	SALISCENDI	100	IDROSCOPINI E KIT DOCCETTA	119
	SOFFIONI DOCCIA	104	FLESSIBILI DOCCIA	122
	BRACCI DOCCIA	109	RICAMBI	123
	DOCCETTE	112		
SANITARI	CERAMICA SANITARIA		128	
	PIATTI DOCCIA		139	
	AUSILI BAGNO DISABILI		152	
	SEDILI		165	
	CASSETTE DI SCARICO		166	
	LAVATOI		174	
COMPLEMENTI SANITARI	SIFONAME		180	
	RUBINETTERIA SOTTOLAVABO, LAVATRICE E VARIA		200	
	FLESSIBILI ACQUA E ANTIVIBRANTI		207	
	SISTEMI DI FISSAGGIO		210	
	TRITURATORI E POMPE SOLLEVAMENTO		211	
PRODOTTI TECNICI	MINUTERIA IDRAULICA E ACCESSORI		216	
	PRODOTTI TECNICI E CHIMICI		222	
	CONTATORI ACQUA		229	
	RUBINETTERIA DA ESTERNO		231	
	RUBINETTI GALLEGGIANTI		233	
ACCESSORI CONDIZIONAMENTO	STAFFE PER CONDIZIONATORI		238	
	SCARICO CONDENSA		239	
	ACCESSORI CONDIZIONAMENTO		240	
	RACCORDERIA A PRESSARE IN RAME			
	PER ARIA CONDIZIONATA E REFRIGERAZIONE		242	
RISCALDAMENTO	SCALDABAGNI	246	CIRCOLATORI	283
	TERMOARREDO ELETTRICO	254	ACCESSORI SOTTOCALDAIA	284
	TERMOARREDO	257	RIDUTTORI DI PRESSIONE	289
	RADIATORI IN ALLUMINIO	262	MANOMETRI E TERMOMETRI	290
	ACCESSORI RADIATORI	279		
IMPIANTISTICA	MULTISTRATO	294	GIUNTI ESTENSIBILI ED ANTIVIBRANTI	
	RACCORDERIA IN OTTONE	302	GAS E ACQUA	343
	RACCORDERIA IN RAME-BRONZO	319	TUBO SOLARE	348
	RACCORDERIA PER TUBO POLIETILENE	337	ISOLAMENTO IN GOMMA	350
			ISOLAMENTO IN POLIETILENE	353



INDICE ANALITICO - CATALOGO LISTINO N° 8 - 2024

	Descrizione prodotto	pag.		Descrizione prodotto	pag.	
A	accessori e curve tecniche per wc	135-221		colla per isolamento in gomma	224-352	
	accessori e ricambi sifoname	197		collettori per impianti sanitari	301	
	accessori per cassette di scarico	169		colonna vasca	190	
	accessori per condizionamento	238		colonne doccia	96	
	accessori per idroscopini e kit doccia	121		colonne doccia inox 316	78	
	accessori per isolamento in gomma	352		colonne doccia multifunzione	88	
	accessori per lavatrice	205		CONDIBAT spray	227-241	
	accessori per scaldabagni elettrici	252		condizionamento: accessori	238	
	accessori per termoarredo	260		conex compression	313	
	accessori per termometri e manometri	291		conex o-ring	315	
	accessori per tubo solare	349		contatori acqua	229	
	accessori radiatori	280		copriforo per lavabo - bidet	219	
	accessori scaldabagni a gas istantanei	247		coprilavatrice	174	
	accessori: lavatoi	177		CS CLEANER disincrostante per cassette WC	227	
	adesivo per pvc - TANGIT	224		cursori per saliscendi	123	
	aeratori	73		curve in poliuretano espanso	355	
	alzawater	160		curve tecniche wc e accessori	135-221	
	antialghe per impianti a pavimento	222		curvette sottolavabo	202	
	antigelo per impianti solari	222		defangatori	287	
	antivibranti	209-241		D DELO' PUR	48	
	asse per lavatoio	177		detergente liquido per giunti elettrosaldabili	227	
	ausili per disabili	152		detergente schiumogeno per condizionatori	227-241	
	B	basi pavimento per unità esterne	240		detergente spray per giunti elettrosaldabili	227
basi pavimento regolabili per unità esterne		240		detergenti per impianti di riscaldamento	222	
BASICFLOW		186		deviatori incasso per doccia	87	
batterie per cassette		169		devolgitore per twin solar slim	349	
benda vinilica		226		disabili: maniglioni	158	
biconi cromati		217-303		disabili: sanitari	152	
biconi ottone tenuta metallica (conex compression)		313		disincrostante cassette	227	
biconi ottone tenuta o-ring		315		disincrostante per scambiatori	222	
bocche di erogazione		70		disotturante liquido	228	
boiler elettrici		249		doccette	112	
bomboletta per ritocchi (RAL 9010)		281		dosatori polifosfati	286	
bracci doccia		109		DRIP STOP mastice bicomponente	224	
bracci doccia inox 316		81		E ERMETIC pasta verde	223	
C		canapa	224		EXTRA GAS pasta marrone	223
		canotti per cassetta	170		F fascette stringitubo per tubo alluminio	347
		canotti per sifoni	195		fascia perimetrale	354
	cartellatrice per tubi flessibili	346		FERNOX	222	
	cartucce per miscelatori	60		filter fluid+protector	222-288	
	cartuccia ricambio kit DELO' PUR	50-71		filtrazione acqua potabile	47	
	cassetta alta in porcellana	138		filtro raccogli impurità	317	
	cassette di scarico - accessori	169		filtro valvola ritegno	317	
	cassette di scarico - ricambi GROHE	172		fissaggi e supporti per sanitari e scaldabagno	210	
	cassette di scarico ad incasso	167		flange in acciaio zincato	342	
	cassette di scarico esterne	166		flessibili acqua	207	
	chiave per aeratori	75		flessibili antivibranti	209	
	chiave per tappi radiatori	280		flessibili doccia	122	
circulatori acqua calda sanitaria	283		flessibili gas per cucina	343		
circulatori per riscaldamento e condizionamento	283		flessibili per caldaia	343		
CLIMAFOAM spray	227-241		flessibili per contatore	345		

INDICE ANALITICO - CATALOGO LISTINO N° 8 - 2024

Descrizione prodotto	pag.
flessibili per gas	343
flessibili per lavatrice	205
fluido termovettore per impianti solari	222
foglia in pvc	355
FONOMETAL	352
G galleggianti	233
galleggianti per cassette di scarico	169-233
giunti antivibranti	344
giunti di transizione	340
giunti dielettrici	340
glicole per termoarredo	261
GROHE BLUE HOME STARTER KIT	47
GROHE SMARTBOX	46-84
GROHE: BAUEDGE lavello	54
GROHE: cassette incasso	167
GROHE: corpi incasso	46-84
GROHE: doccette	113
GROHE: filtro BWT per GROHE BLUE	47-71
GROHE: GROHE BLUE PURE NEW BAUCURVE STARTER KIT	51
GROHE: ricambi per cassetta	172
GROHE: ricambi per rubinetteria	62
GROHE: rubinetteria elettronica	45
GROHE: saliscendi	102
GROHE: serie EUROSART	38
guaina isolante in rotoli (FONOMETAL)	352
guarnizioni per radiatori	281
I idroscopini	119
ISOFOM R	354
isolamento in gomma	350
isolamento in gomma per solare	349
isolamento in polietilene	353
ISOPIU'	355
K KINEWALL pannelli di rivestimento doccia	150-151
kit antivibranti per condizionatori	241
kit DELO' PUR	48
kit doccetta	115
kit flessibili per caldaia	345
kit sottocaldaia defangatore e dosatore	287
kit tappi per radiatori	279
kit tubo corrugato gas per uso domestico	343-346
KOLMAT pasta	223
L lastra isolante in rotoli	351
lavabi d'arredo	137
lavabo ad angolo in porcellana	138
lavatoi in resina con mobile	174
lavatrice: accessori	205
LOCTITE	223
lubrificante multiuso WD 40	228
M manicotti per wc	220
maniglioni per disabili INOX	159
maniglioni per disabili verniciati	158

Descrizione prodotto	pag.
manometri	290
mensole per condizionatori	238
mensole per radiatori	282
MINIFLOW	187
minuteria idraulica	216
miscelatore lavello cucina 3 acque GIULIO	48-52
miscelatore lavello cucina 3 acque MARIO	49-52
mobiletto sottoceramica	176
mobili lavanderia	174
morsetti per wc e curve tecniche	219
multistrato	294
N NANOFLOW	186
nastri adesivi	226
nastri P.T.F.E. (teflon)	225
nastro alluminio	226
nastro anticondensa	225-241-352
nastro dielettrico	226
nastro segnaletico ACQUA	226
nastro segnaletico GAS	226
neutralizzatori di condensa	285
NEUTRASLIM	285
O orinatoio sospeso in ceramica	138
P pannelli di rivestimento doccia	150-151
pasta KOLMAT	223
pasta marrone	223
pasta verde	223
piatti doccia in ardesia	140
piatti doccia in porcellana	139
piatti doccia per disabili	155
piedini antivibranti	240
piletta lavabo bidet INOX	191
pilette lavabo e bidet	72-191
pilette lavello	193
pilette sifonate e set piatti doccia	186
pilozzi in polipropilene	177
pilozzi in porcellana	138
POLAR	353
polifosfati in capsule, polvere e liquido	286
pompa scarico condensa per caldaia	284
pompe di calore - scaldabagni	248
pompe di sollevamento e tritadori	211
pompe scarico condensa per condizionatori	238
porcellana per bagno	128
portagomma in ottone	231
portasapone per saliscendi	124
prese a staffa in polipropilene (pp)	339
prese acqua inox 316	82
prese d'acqua	116
prodotti chimici	222
protettivo per impianti di riscaldamento	222
R raccorderia elettrosaldabile	341

INDICE ANALITICO - CATALOGO LISTINO N° 8 - 2024

Descrizione prodotto	pag.	Descrizione prodotto	pag.
raccorderia in bronzo a brasare	323	rubinetteria leva clinica	59
raccorderia in bronzo a pressare per acqua	331	rubinetteria per colonne doccia	86
raccorderia in bronzo a pressare per acqua e gas	327	rubinetteria termostatica	85
raccorderia in bronzo a pressare per gas	334	rubinetteria: deviatori incasso per doccia	87
raccorderia in ottone con o-ring	315	rubinetteria: ricambi	60
raccorderia in ottone conex compression	313	rubinetteria: serie DADO	20
raccorderia in ottone cromata filettatura cilindrica	302	rubinetteria: serie DELFINO DUE	36
raccorderia in ottone cromata filettatura conica	304	rubinetteria: serie EUROSMART	38
raccorderia in ottone giallo filettatura cilindrica	311	rubinetteria: serie EVA	40
raccorderia in ottone giallo filettatura conica	306	rubinetteria: serie MAYA	29
raccorderia in rame a brasare	319	rubinetteria: serie NEMO	34
raccorderia in rame a pressare per acqua	329	rubinetteria: serie TONDA	24
raccorderia in rame a pressare per acqua e gas	325	rubinetteria: serie TRADIZIONALE	43
raccorderia in rame a pressare per condizionamento	242-335	rubinetteria: serie ZERO	32
raccorderia in rame a pressare per gas	333	rubinetti antighiaccio	231
raccorderia per multistrato per acqua	296	rubinetti galleggianti	233
raccorderia per multistrato per gas	294	rubinetti galleggianti per cassette di scarico	169
raccorderia per tubo flessibile cartellabile	346	rubinetti per cassetta wc	171-203
raccorderia per tubo impianti solari	349	rubinetti per idrante	231
raccorderia per tubo polietilene	337-341	rubinetti per lavatrice	204
raccordi a compressione per multistrato acqua	300	rubinetti sottolavabo a sfera	200
raccordi per contatore	229	rubinetti sottolavabo a vitone	201
raccordi per scaldabagno	210-253	S saliscendi	100
raccordi per tubo ferro	318	saliscendi inox 316	80
raccordo 5 vie	318	SANICOMPACT	212
radiatori alluminio: accessori	280	SANICONDENS PRO	284
radiatori alluminio: modello ANTEPRIMA	262	SANICUBIC 1	213
radiatori alluminio: modello KLASS	276	sanificante per condizionatori	227-241
radiatori alluminio: modello MIX	272	SANINEUTRAL	285
radiatori alluminio: modello OSCAR	277	SANIPACK PRO	212
radiatori alluminio: modello OSCAR TONDO	278	SANIPLUS	211
radiatori alluminio: modello SEBINO	270	SANISLIM	211
radiatori alluminio: modello TONALE	266	sanitari per disabili	152
radiatori alluminio: modello VIP	275	sanitari per disabili: accessori	156
radiatori alluminio: modello VOX	273	sanitari per disabili: alzawater	160
radiatori alluminio: modello VOX EXTRA	274	sanitari per disabili: maniglioni	158
ricambi e accessori sifoname	197	sanitari per disabili: piatti doccia	155
ricambi linea doccia	123	sanitari per disabili: seggiolini e sgabelli	161
ricambi per scaldabagni elettrici	252	sanitari per disabili: serie CASUAL	152
ricambi rubinetteria cromata	60	sanitari: piatti doccia	139
ricariche neutralizzatori di condensa	285	sanitari: serie 4ALL	128
ricariche polifosfati in capsule, polvere e liquido	286	sanitari: serie GRACE	133
riduttori di pressione	289	sanitari: serie MODE	131
rigenerante per impianti di riscaldamento	222	SANITOP	211
rilevatore fughe gas	228	SANITRIT	211
rosette per radiatori	282	saracinesche	317
rosoni	218	sbobinatrice per TWIN SOLAR SLIM	349
rubinetteria da cucina	52	scaldabagni a gas istantanei	246
rubinetteria da esterno	231	scaldabagni elettrici	249
rubinetteria elettronica	45	scaldabagni elettrici TITANO	249
rubinetteria inox 316: serie LOLA	18	scaldabagni in pompa di calore	248

INDICE ANALITICO - CATALOGO LISTINO N° 8 - 2024

Descrizione prodotto	pag.
schiuma poliuretana	224
scivolina	227
sedili anticontatto	160
sedili sgancio rapido	164
sedili universali e adattabili	164
sedili: alzatawater per disabili	160
sedili: per serie ausili disabili	153
seggiolini per disabili	161
serpentine per manometri	291
set doccia	115
set doccia inox 316	82
sfere per rubinetti galleggianti	235
sgabelli per doccia	161
SGORGOSI' - SGORGOSI' GEL	228
sifone a vista INOX	180
sifone incasso doppio attacco	205-239
sifoni a vista in ottone	180
sifoni abs cromati	183
sifoni in ottone	181
sifoni in polipropilene (pp) lavabo e bidet	184
sifoni lavatrice	205
sifoni lavello	185
sifoni pavimento	186
sifoni per piatti doccia	189
sifoni scarico condensa	239
sifoni tubolari in ottone	182
sifoni vasca	190
sigillaperdite bicomponente	224
sigillaperdite per impianti di riscaldamento	222
siliconi e sigillanti	223
soffioni doccia acciaio	106
soffioni doccia economici	108
soffioni doccia in abs	107
soffioni doccia in ottone	104
soffioni doccia inox 316	81
solvacal disincrostante in polvere	227
spandiacqua per turca	170
spray per giunti elettrosaldabili	227
staffe per condizionatori	238
staffe per sanitari sospesi	168-210
stazione di sollevamento	213
strisce butiliche	224
supporti a pavimento regolabili	240
supporti doccia	118
supporti e fissaggi per sanitari e scaldabagno	210
supporto regolabile per pilozzo	210
T TANGIT	224
TANGIT detergente	227
tappi copriforo	219
tappi e riduzioni per radiatori	279
tappi per piletta	198

Descrizione prodotto	pag.
tappi prova impianto	219
teflon in nastri	225
telo protettivo per unità esterne	241
termoarredo elettrico: modello CLOE	254
termoarredo: accessori	260
termoarredo: modello GIADA	257
termomanometri	290
termometri	291
termometri e manometri: accessori	291
termostatici esterni	85
termostatici incasso	83
termostatici per colonne doccia	86
tracciante vernice spray	228
trattamento e manutenzione impianti	222
triturator	211
tubi cromati in ottone e rame	216
tubo alluminio bianco	347
tubo alluminio naturale	347
tubo carico e scarico lavatrice	205
tubo cartellabile per acqua e gas	346
tubo corrugato gas uso domestico	346
tubo estensibile per lavabi e lavelli	197
tubo estensibile per WC	221
tubo gas per uso domestico	343
tubo multistrato acqua	296
tubo multistrato gas	294
tubo per impianti solari	348
tubo poliuretano espanso (ISOPIU')	355
tubo scarico per cassette wc	170
TUBOFIX	318
TWIN SOLAR SLIM	348
V valvola esterna lavatrice	206
valvole clapet	318
valvole di fondo	317
valvole di ritegno	317
valvole sfogo aria	281
vetrochina e fire clay	128
vitoni per rubinetteria e termostatici	65
W WD 40 lubrificante multifunzione	228
WOLTMANN contatori	230

CATALOGO
LISTINO N° 8

RUBINETTERIA

RUBINETTERIA INOX 316	18
RUBINETTERIA BAGNO	20
FILTRAZIONE ACQUA POTABILE	47
RUBINETTERIA CUCINA	52
RUBINETTERIA LEVA CLINICA	59
RICAMBI RUBINETTERIA	60

RUBINETTERIA INOX 316

Serie LOLA

La serie LOLA è realizzata in acciaio INOX 316L, materiale particolarmente resistente alla corrosione. Dispone di una cartuccia da 25 mm.

LAVABO



Scarico automatico 1"1/4 spessore regolabile, con meccanismo clicker. Portata litri/min: 10,5

RICAMBI (PAG. 60-75)
3101147 - Cartuccia D. 25
2751200 - Aeratore cachè

codice	UM	min. ord.	conf.	cat.	prezzo (€)
● 3004101	NR	1	1	03	391,02

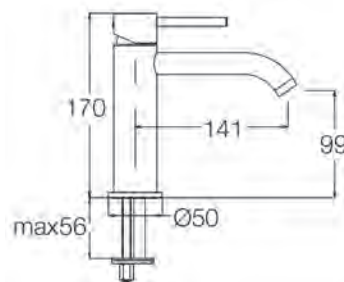

LAVABO BIG SIZE



Scarico automatico 1"1/4 spessore regolabile, con meccanismo clicker. Portata litri/min: 10,5

RICAMBI (PAG. 60-75)
3101147 - Cartuccia D. 25
2751200 - Aeratore cachè

codice	UM	min. ord.	conf.	cat.	prezzo (€)
● 3004103	NR	1	1	03	492,49

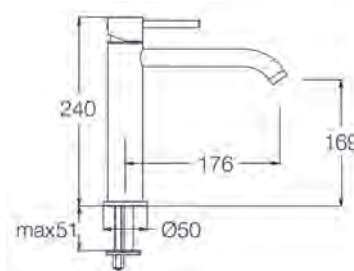

LAVABO ALTO



Scarico automatico 1"1/4 spessore regolabile, con meccanismo clicker. Portata litri/min: 10,3

RICAMBI (PAG. 60-75)
3101147 - Cartuccia D. 25
2751200 - Aeratore cachè

codice	UM	min. ord.	conf.	cat.	prezzo (€)
● 3004105	NR	1	1	03	579,08

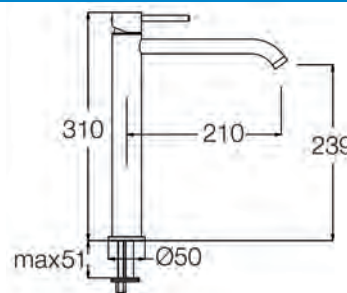

LAVABO A PARETE SOLO PARTI ESTERNE



Solo parti esterne da completare con il corpo incasso (3004108) Bocca di erogazione a sinistra, non reversibile. Scarico automatico 1"1/4 con meccanismo clicker.

codice	UM	min. ord.	conf.	cat.	prezzo (€)
● 3004107	NR	1	1	03	276,01

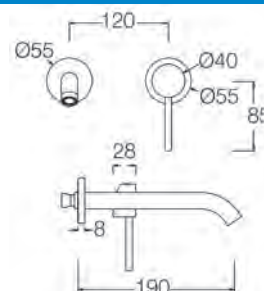

CORPO INCASSO LAVABO A PARETE



Portata litri/min: 19,5

RICAMBI (PAG. 60-75)
3101042 - Cartuccia D. 35

codice	UM	min. ord.	conf.	cat.	prezzo (€)
● 3004108	NR	1	1	03	282,78

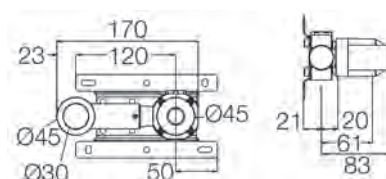

BIDET



Scarico automatico 1"1/4 spessore regolabile, con meccanismo clicker.
Portata litri/min: 10,1

RICAMBI (PAG. 60-75)
3101147 - Cartuccia D. 25
2751200 - Aeratore cachè

codice	UM	min. ord.	conf.	cat.	prezzo (€)
● 3004109	NR	1	1	03	391,02

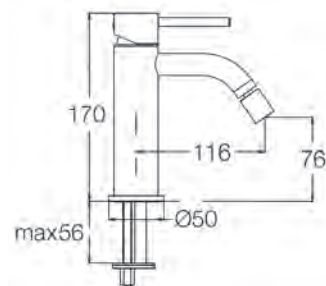

DOCCIA INCASSO CON DEVIATORE SOLO PARTI ESTERNE



Solo parti esterne da completare con il corpo incasso (3004114)

codice	UM	min. ord.	conf.	cat.	prezzo (€)
● 3004113	NR	1	1	03	276,01

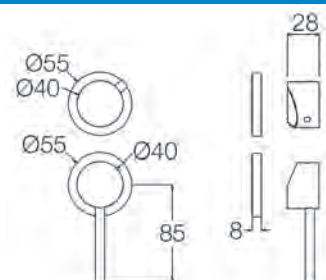

CORPO INCASSO DOCCIA 2 VIE



Portata litri/min: 17

RICAMBI (PAG. 60-75)
3101042 - Cartuccia D. 35

codice	UM	min. ord.	conf.	cat.	prezzo (€)
● 3004114	NR	1	1	03	377,49

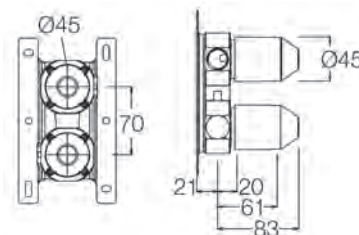

DOCCIA INCASSO SOLO PARTI ESTERNE



Solo parti esterne da completare con il corpo incasso (3004112)

codice	UM	min. ord.	conf.	cat.	prezzo (€)
● 3004111	NR	1	1	03	159,65

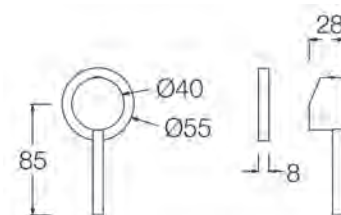

CORPO INCASSO DOCCIA 1 VIA



Portata litri/min: 22

RICAMBI (PAG. 60-75)
3101042 - Cartuccia D. 35

codice	UM	min. ord.	conf.	cat.	prezzo (€)
● 3004112	NR	1	1	03	211,07

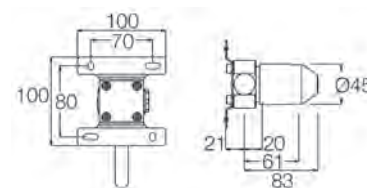

RUBINETTERIA BAGNO

Serie DADO

POSSIBILI FINITURE



Nero opaco



Bianco opaco



Simil acciaio

LAVABO



Scarico automatico 1"1/4 spessore regolabile, con meccanismo clicker.

RICAMBI (PAG. 60-75)

3101102 - Maniglia cromo

3101097 - Cartuccia D. 25

codice	finitura	UM	min. ord.	conf.	cat.	prezzo (€)
● 3001010	cromo	NR	1	10	03	185,55
● 3001910	nero opaco	NR	1	5	03	242,37
● 3001710	bianco opaco	NR	1	5	03	242,37
● 3001810	simil acciaio	NR	1	5	03	280,20

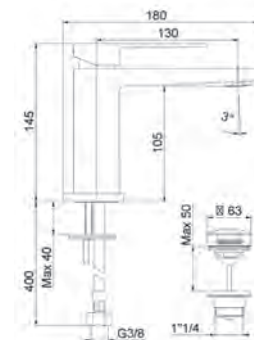

LAVABO "BIG SIZE"



Scarico automatico 1"1/4 spessore regolabile, con meccanismo clicker.

RICAMBI (PAG. 60-75)

3101102 - Maniglia cromo

3101097 - Cartuccia D. 25

codice	finitura	UM	min. ord.	conf.	cat.	prezzo (€)
● 3001027	cromo	NR	1	1	03	200,88
● 3001927	nero opaco	NR	1	1	03	261,15
● 3001727	bianco opaco	NR	1	1	03	261,15
● 3001827	simil acciaio	NR	1	1	03	301,32



LAVABO ALTO



Scarico automatico 1"1/4 spessore regolabile, con meccanismo clicker.

RICAMBI (PAG. 60-75)

3101102 - Maniglia cromo

3101097 - Cartuccia D. 25

codice	finitura	UM	min. ord.	conf.	cat.	prezzo (€)
● 3001011	cromo	NR	1	5	03	272,64
● 3001911	nero opaco	NR	1	5	03	355,95
● 3001711	bianco opaco	NR	1	5	03	355,41
● 3001811	simil acciaio	NR	1	5	03	408,33



LAVABO A PARETE 2 PEZZI

Bocca di erogazione lunghezza totale 190 mm., senza scarico.



RICAMBI (PAG. 60-75)
3101103 - Maniglia cromo
3101098 - Cartuccia D. 42

	codice	finitura	UM	min. ord.	conf.	cat.	prezzo (€)
●	3001013	cromo	NR	1	5	03	215,85
●	3001913	nero opaco	NR	1	5	03	280,20
	3001713	bianco opaco	NR	1	5	03	279,78
●	3001813	simil acciaio	NR	1	5	03	321,39

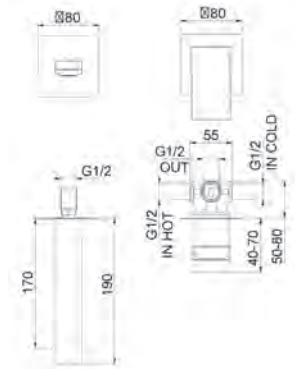

BIDET

Scarico automatico 1"1/4 spessore regolabile, con meccanismo clicker.



RICAMBI (PAG. 60-75)
3101102 - Maniglia cromo
3101097 - Cartuccia D. 25

	codice	finitura	UM	min. ord.	conf.	cat.	prezzo (€)
●	3001012	cromo	NR	1	10	03	184,02
●	3001912	nero opaco	NR	1	5	03	242,37
	3001712	bianco opaco	NR	1	5	03	242,37
●	3001812	simil acciaio	NR	1	5	03	280,20

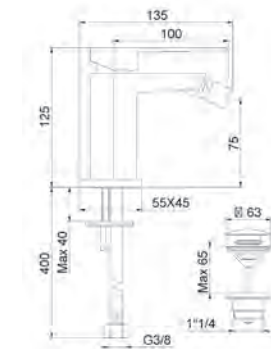

DOCCIA INCASSO CON DEVIATORE

Deviatore a pulsante. Incluso corpo incasso.



RICAMBI (PAG. 60-75)
3101103 - Maniglia cromo
3101098 - Cartuccia D. 42
3101124 - Prolunga cromo

	codice	finitura	UM	min. ord.	conf.	cat.	prezzo (€)
●	3001015	cromo	NR	1	10	03	132,57
●	3001915	nero opaco	NR	1	10	03	172,29
	3001715	bianco opaco	NR	1	10	03	172,05
●	3001815	simil acciaio	NR	1	10	03	196,95

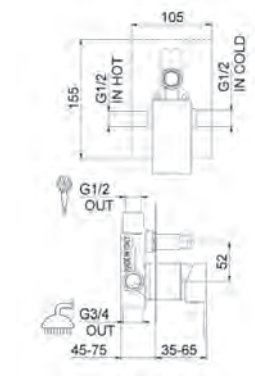

DOCCIA INCASSO

Incluso corpo incasso.



RICAMBI (PAG. 60-75)
3101103 - Maniglia cromo
3101098 - Cartuccia D. 42
3101123 - Prolunga cromo

	codice	finitura	UM	min. ord.	conf.	cat.	prezzo (€)
●	3001014	cromo	NR	1	10	03	71,91
●	3001914	nero opaco	NR	1	10	03	92,79
	3001714	bianco opaco	NR	1	10	03	92,64
●	3001814	simil acciaio	NR	1	10	03	100,53

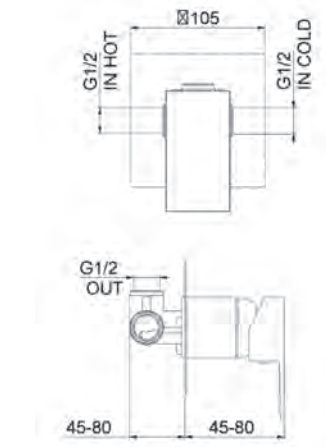

RUBINETTERIA BAGNO

Serie DADO

DOCCIA INCASSO CON DEVIATORE SOLO PARTI ESTERNE

Solo parti esterne cromate, da completare con il corpo incasso a due vie (3005102). Deviatore a pulsante.



RICAMBI (PAG. 60-75)

3101103 - Maniglia cromo

codice	finitura	UM	min. ord.	conf.	cat.	prezzo (€)
● 3001020	cromo	NR	1	10	03	30,63

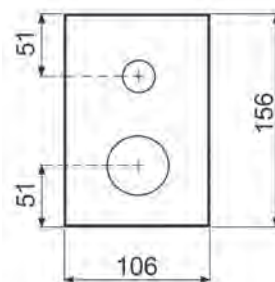

Corpo incasso 2 vie con protezione.

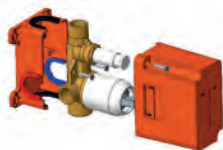

codice	finitura	UM	min. ord.	conf.	cat.	prezzo (€)
● 3005102	cromo	NR	1	1	03	108,60

DOCCIA INCASSO SOLO PARTI ESTERNE

Solo parti esterne cromate, da completare con il corpo incasso a una via (3005101).

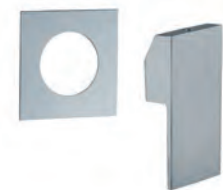

RICAMBI (PAG. 60-75)

3101103 - Maniglia cromo

codice	finitura	UM	min. ord.	conf.	cat.	prezzo (€)
● 3001019	cromo	NR	1	10	03	23,61

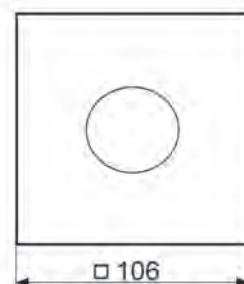

Corpo incasso 1 via con protezione.



codice	finitura	UM	min. ord.	conf.	cat.	prezzo (€)
● 3005101	cromo	NR	1	1	03	53,76

DOCCIA INCASSO CON DEVIATORE 3 VIE

Deviatore a manopola. Compreso corpo incasso.



RICAMBI (PAG. 60-75)

3101103 - Maniglia miscelatrice cromo

3101098 - Cartuccia D. 42

codice	finitura	UM	min. ord.	conf.	cat.	prezzo (€)
● 3001016	cromo	NR	1	10	03	280,11
● 3001916	nero opaco	NR	1	1	03	378,66
● 3001716	bianco opaco	NR	1	1	03	378,09
● 3001816	simil acciaio	NR	1	1	03	442,32



DOCCIA ESTERNO



RICAMBI (PAG. 60-75)
3101102 - Maniglia cromo
3101097 - Cartuccia D. 25

	codice	finitura	UM	min. ord.	conf.	cat.	prezzo (€)
●	3001018	cromo	NR	1	5	03	181,77
	3001918	nero opaco	NR	1	5	03	234,42
	3001718	bianco opaco	NR	1	5	03	234,42
	3001818	simil acciaio	NR	1	5	03	272,22

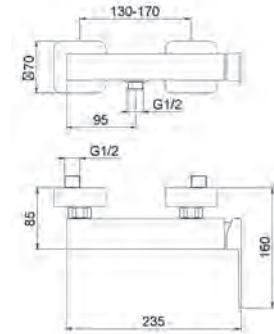

VASCA CON KIT DOCCIA

Flessibile cm 150 silver.



RICAMBI (PAG. 60-75)
3101102 - Maniglia cromo
3101097 - Cartuccia D. 25

	codice	finitura	UM	min. ord.	conf.	cat.	prezzo (€)
●	3001017	cromo	NR	1	5	03	291,60
	3001917	nero opaco	NR	1	5	03	416,52
	3001717	bianco opaco	NR	1	5	03	415,89
	3001817	simil acciaio	NR	1	5	03	472,59

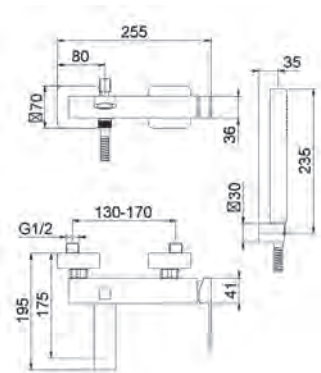

VASCA A PAVIMENTO

Kit per fissaggio e collegamento non compreso.



RICAMBI (PAG. 60-75)
3101100 - Cartuccia D. 35

	codice	finitura	UM	min. ord.	conf.	cat.	prezzo (€)
●	3001026	cromo	NR	1	1	03	1.347,84
	3001926	nero opaco	NR	1	1	03	1.607,04
	3001726	bianco opaco	NR	1	1	03	1.607,04
	3001826	simil acciaio	NR	1	1	03	1.927,80

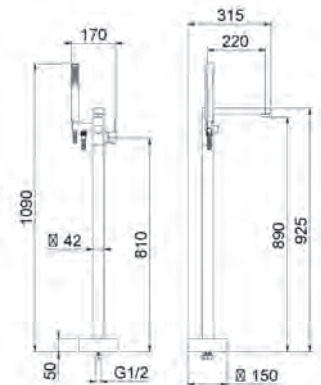

RUBINETTERIA BAGNO

Serie TONDA

POSSIBILI FINITURE



Nero opaco



Simil acciaio

LAVABO

Scarico 1"1/4



RICAMBI (PAG. 60-75)

3101106 - Maniglia cromo

3101101 - Cartuccia D. 35

2751200 - Areatore cachè

	codice	finitura	UM	min. ord.	conf.	cat.	prezzo (€)
●	3021010	cromo	NR	1	5	03	170,43
●	3021910	nero opaco	NR	1	5	03	227,22
●	3021810	simil acciaio	NR	1	5	03	268,86



LAVABO CLICK/CLACK

Scarico automatico 1"1/4, spessore regolabile con meccanismo clicker.



RICAMBI (PAG. 60-75)

3101106 - Maniglia cromo

3101101 - Cartuccia D. 35

2751200 - Areatore cachè

	codice	finitura	UM	min. ord.	conf.	cat.	prezzo (€)
●	3021026	cromo	NR	1	5	03	201,93
●	3021926	nero opaco	NR	1	5	03	283,08
●	3021826	simil acciaio	NR	1	5	03	323,04

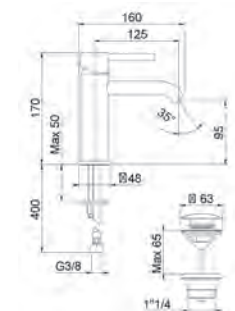

LAVABO ALTO

Scarico automatico 1"1/4, spessore regolabile con meccanismo clicker.



RICAMBI (PAG. 60-75)

3101106 - Maniglia cromo

3101101 - Cartuccia D. 35

	codice	finitura	UM	min. ord.	conf.	cat.	prezzo (€)
●	3021011	cromo	NR	1	5	03	261,30
●	3021911	nero opaco	NR	1	5	03	337,02
●	3021811	simil acciaio	NR	1	5	03	386,07

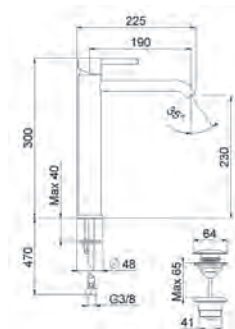

LAVABO A PARETE 2 PEZZI

Senza scarico.



RICAMBI (PAG. 60-75)
3101157 - Maniglia cromo
3101098 - Cartuccia D. 42

codice	finitura	UM	min. ord.	conf.	cat.	prezzo (€)
● 3021013	cromo	NR	1	5	03	151,50
● 3021913	nero opaco	NR	1	5	03	196,95
3021813	simil acciaio	NR	1	5	03	227,22

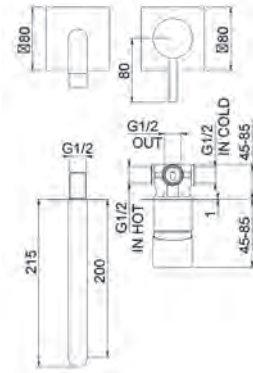

LAVABO A PARETE PIASTRA UNICA

Senza scarico.



RICAMBI (PAG. 60-75)
3101106 - Maniglia cromo
3101100 - Cartuccia D. 35

codice	finitura	UM	min. ord.	conf.	cat.	prezzo (€)
● 3021014	cromo	NR	1	5	03	182,40
3021914	nero opaco	NR	1	5	03	219,27
3021814	simil acciaio	NR	1	5	03	253,77

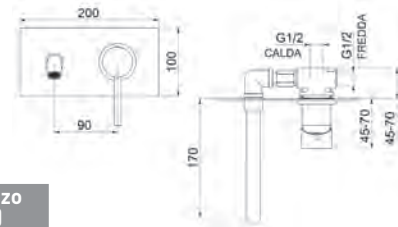

BIDET

Scarico 1"1/4



RICAMBI (PAG. 60-75)
3101106 - Maniglia cromo
3101101 - Cartuccia D. 35
2751200 - Aeratore

codice	finitura	UM	min. ord.	conf.	cat.	prezzo (€)
● 3021012	cromo	NR	1	5	03	170,43
● 3021912	nero opaco	NR	1	5	03	227,22
● 3021812	simil acciaio	NR	1	5	03	268,86

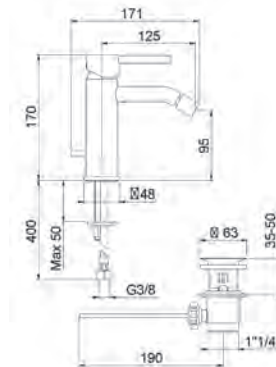

BIDET CLICK/CLACK

Scarico automatico 1"1/4, spessore regolabile con meccanismo clicker.



RICAMBI (PAG. 60-75)
3101106 - Maniglia cromo
3101101 - Cartuccia D. 35
2751200 - Aeratore

codice	finitura	UM	min. ord.	conf.	cat.	prezzo (€)
● 3021027	cromo	NR	1	5	03	202,23
● 3021927	nero opaco	NR	1	5	03	283,08
3021827	simil acciaio	NR	1	5	03	323,04

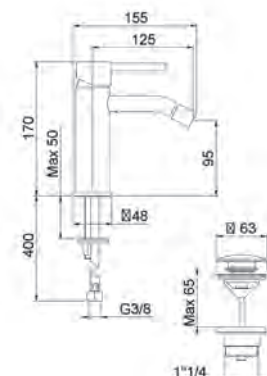

RUBINETTERIA BAGNO

Serie TONDA

DOCCIA INCASSO CON DEVIATORE

Deviatore a pulsante. Incluso corpo incasso



RICAMBI (PAG. 60-75)

3101157 - Maniglia cromo

3101098 - Cartuccia D. 42

3101124 - Prolunga cromo

	codice	finitura	UM	min. ord.	conf.	cat.	prezzo (€)
●	3021016	cromo	NR	1	10	03	151,50
●	3021916	nero opaco	NR	1	10	03	196,95
●	3021816	simil acciaio	NR	1	10	03	227,22

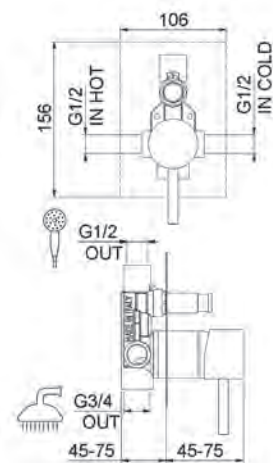

DOCCIA INCASSO

Incluso corpo incasso.



RICAMBI (PAG. 60-75)

3101157 - Maniglia cromo

3101098 - Cartuccia D. 42

3101123 - Prolunga cromo

	codice	finitura	UM	min. ord.	conf.	cat.	prezzo (€)
●	3021015	cromo	NR	1	10	03	79,53
●	3021915	nero opaco	NR	1	1	03	113,64
●	3021815	simil acciaio	NR	1	1	03	136,11

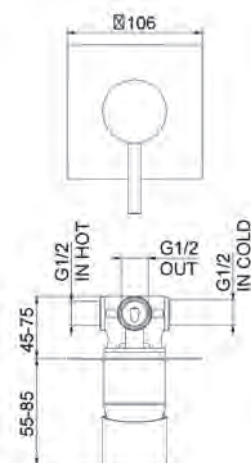

DOCCIA INCASSO CON DEVIATORE 2 VIE

Deviatore a manopola. Compreso corpo incasso.



RICAMBI (PAG. 60-75)

3101106 - Maniglia miscelatrice cromo

3101100 - Cartuccia D. 35

	codice	finitura	UM	min. ord.	conf.	cat.	prezzo (€)
●	3021017	cromo	NR	1	10	03	246,15
●	3021917	nero opaco	NR	1	1	03	317,58
●	3021817	simil acciaio	NR	1	1	03	363,54

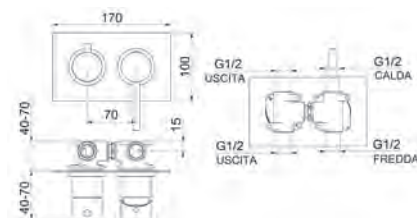

DOCCIA INCASSO CON DEVIATORE 3 VIE

Deviatore a manopola. Compreso corpo incasso.



RICAMBI (PAG. 60-75)

3101157 - Maniglia miscelatrice cromo

3101098 - Cartuccia D. 42

codice	finitura	UM	min. ord.	conf.	cat.	prezzo (€)
● 3021018	cromo	NR	1	5	03	295,38
● 3021918	nero opaco	NR	1	5	03	385,62
● 3021818	simil acciaio	NR	1	5	03	446,13

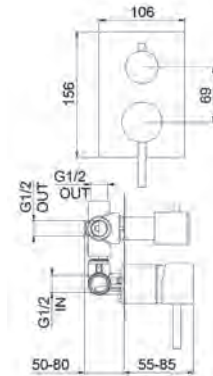

DOCCIA INCASSO CON DEVIATORE SOLO PARTI ESTERNE

Solo parti esterne cromate, da completare con il corpo incasso a due vie (3005102). Deviatore a pulsante



RICAMBI (PAG. 60-75)

3101157 - Maniglia cromo

codice	finitura	UM	min. ord.	conf.	cat.	prezzo (€)
● 3021022	cromo	NR	1	10	03	49,41

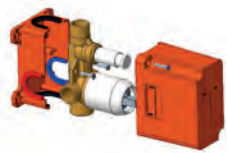
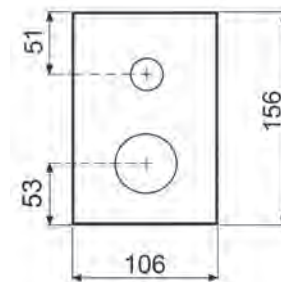

Corpo incasso 2 vie con protezione.

codice	finitura	UM	min. ord.	conf.	cat.	prezzo (€)
● 3005102	cromo	NR	1	1	03	108,60

DOCCIA INCASSO SOLO PARTI ESTERNE

Solo parti esterne cromate, da completare con il corpo incasso a una via (3005101)



RICAMBI (PAG. 60-75)

3101157 - Maniglia cromo

codice	finitura	UM	min. ord.	conf.	cat.	prezzo (€)
● 3021021	cromo	NR	1	10	03	41,16

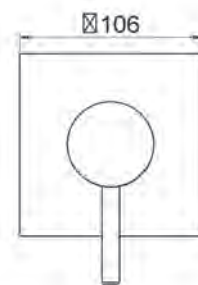

Corpo incasso 1 via con protezione.

codice	finitura	UM	min. ord.	conf.	cat.	prezzo (€)
● 3005101	cromo	NR	1	1	03	53,76

RUBINETTERIA BAGNO

Serie TONDA

DOCCIA ESTERNO



RICAMBI (PAG. 60-75)
 3101104 - Maniglia cromo
 3101099 - Cartuccia D. 35

	codice	finitura	UM	min. ord.	conf.	cat.	prezzo (€)
●	3021020	cromo	NR	1	5	03	179,88
	3021920	nero opaco	NR	1	5	03	226,86
	3021820	simil acciaio	NR	1	5	03	264,69

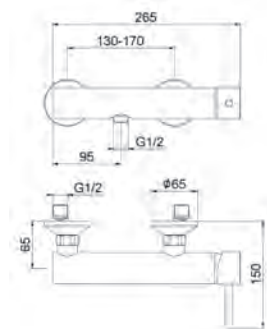

VASCA CON KIT DOCCIA



Flessibile 150 cm

RICAMBI (PAG. 60-75)
 3101100 - Cartuccia D. 35

	codice	finitura	UM	min. ord.	conf.	cat.	prezzo (€)
●	3021019	cromo	NR	1	5	03	302,55
	3021919	nero opaco	NR	1	5	03	374,52
	3021819	simil acciaio	NR	1	5	03	431,25

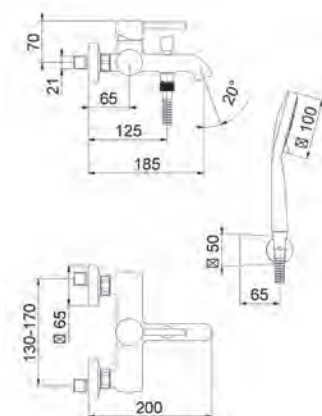

VASCA A PAVIMENTO



Compreso kit per fissaggio e collegamento

RICAMBI (PAG. 60-75)
 3101106 - Maniglia cromo

	codice	finitura	UM	min. ord.	conf.	cat.	prezzo (€)
●	3021031	cromo	NR	1	1	03	1.265,22
	3021931	nero opaco	NR	1	1	03	1.771,32
	3021831	simil acciaio	NR	1	1	03	2.024,34

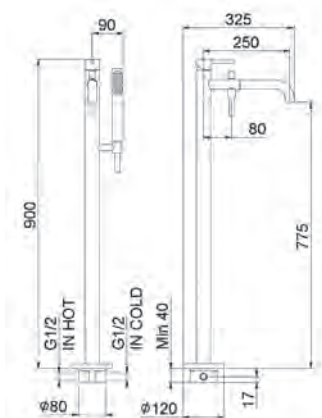

La serie MAYA dispone di una particolare tecnologia per l'ottimizzazione dell'efficienza energetica:

LIMITATORE DI ENERGIA: Apertura dell'erogazione dell'acqua fredda con leva in posizione centrale, evitando l'accensione involontaria della caldaia. Inserito sugli artt. 3008001, 3008002, 3008003, 3008010.

LIMITATORE DI TEMPERATURA: permette di decidere la temperatura massima dell'acqua.

REGOLATORE DINAMICO DI PORTATA: blocca l'alzata della leva al raggiungimento della metà della portata, riducendo il consumo del 50%.

CARTUCCIA D. 35 mm A IMMERSIONE TOTALE: diminuisce l'usura meccanica della cartuccia

LAVABO

Scarico 1"1/4



5
l/min

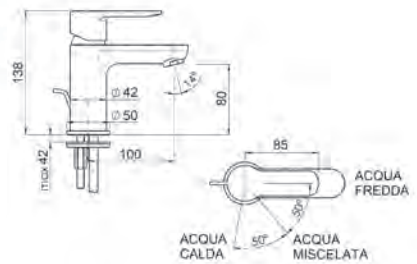

RICAMBI (PAG. 60-75)
3008903 - Maniglia
3008908 - Cartuccia

codice	UM	min. ord.	conf.	cat.	prezzo (€)
● 3008001	NR	1	10	03	111,18

LAVABO MANIGLIA STANDARD

Scarico 1"1/4, apertura maniglia classica.



RICAMBI (PAG. 60-75)
3008913 - Maniglia
3008906 - Cartuccia

codice	UM	min. ord.	conf.	cat.	prezzo (€)
● 3008011	NR	1	10	03	111,18

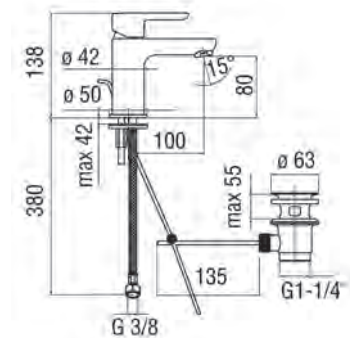

LAVABO "BIG SIZE"

Scarico 1"1/4



5
l/min

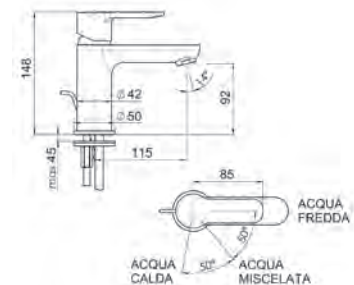

RICAMBI (PAG. 60-75)
3008903 - Maniglia
3008908 - Cartuccia

codice	UM	min. ord.	conf.	cat.	prezzo (€)
● 3008010	NR	1	10	03	170,40

LAVABO "BIG SIZE" MANIGLIA STANDARD

Scarico 1"1/4, apertura maniglia classica.



RICAMBI (PAG. 60-75)
3008913 - Maniglia
3008906 - Cartuccia

codice	UM	min. ord.	conf.	cat.	prezzo (€)
● 3008009	NR	1	10	03	170,40

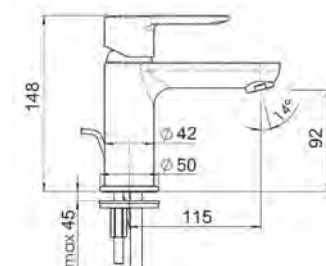

RUBINETTERIA BAGNO

Serie MAYA

LAVABO CORPO ALTO



Scarico automatico 1"1/4,
con meccanismo clicker.

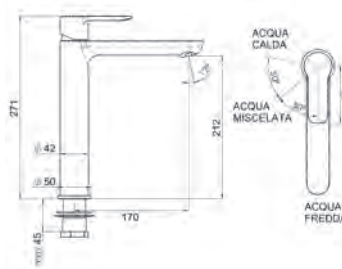

RICAMBI (PAG. 60-75)
3008903 - Maniglia
3008908 - Cartuccia

codice	UM	min. ord.	conf.	cat.	prezzo (€)
● 3008002	NR	1	6	03	225,54

BIDET



Scarico 1"1/4

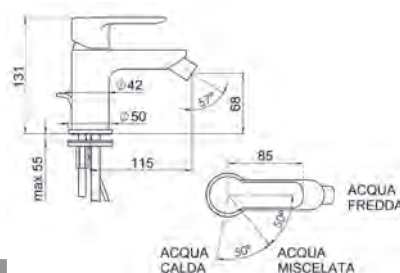

RICAMBI (PAG. 60-75)
3008903 - Maniglia
3008908 - Cartuccia
2751204 - Aeratore cachè

codice	UM	min. ord.	conf.	cat.	prezzo (€)
● 3008003	NR	1	10	03	111,18

BIDET MANIGLIA STANDARD



Scarico 1"1/4, apertura maniglia classica.

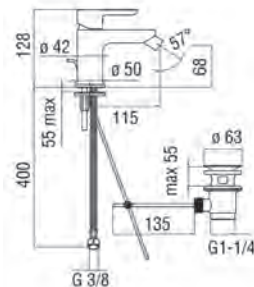

RICAMBI (PAG. 60-75)
3008913 - Maniglia
3008906 - Cartuccia
2751204 - Aeratore cachè

codice	UM	min. ord.	conf.	cat.	prezzo (€)
● 3008012	NR	1	12	03	111,18

DOCCIA INCASSO CON DEVIATORE



Incluso corpo incasso

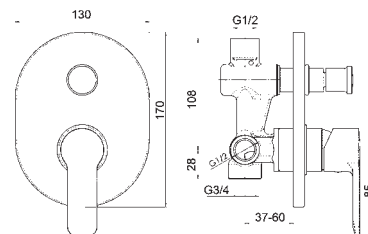

RICAMBI (PAG. 60-75)
3008913 - Maniglia
3008904 - Cartuccia
3008910 - Deviatore
3008918 - Prolunga

codice	UM	min. ord.	conf.	cat.	prezzo (€)
● 3008006	NR	1	8	03	190,65

DOCCIA INCASSO

Incluso corpo incasso



RICAMBI (PAG. 60-75)
 3008913 - Maniglia
 3008904 - Cartuccia
 3008919 - Prolunga

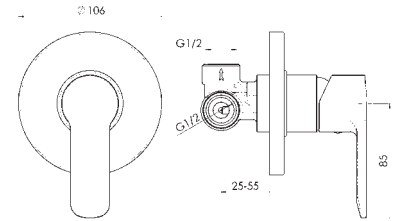

codice	UM	min. ord.	conf.	cat.	prezzo (€)
● 3008004	NR	1	30	03	79,41

DOCCIA ESTERNO



RICAMBI (PAG. 60-75)
 3008913 - Maniglia
 3008904 - Cartuccia

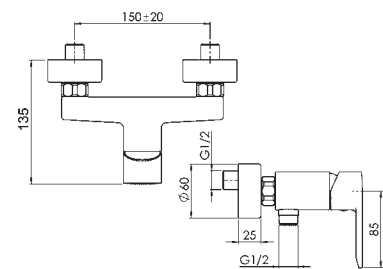

codice	UM	min. ord.	conf.	cat.	prezzo (€)
● 3008005	NR	1	20	03	144,60

VASCA CON KIT DOCCIA

Flessibile cm. 150



RICAMBI (PAG. 60-75)
 3008913 - Maniglia
 3008905 - Cartuccia

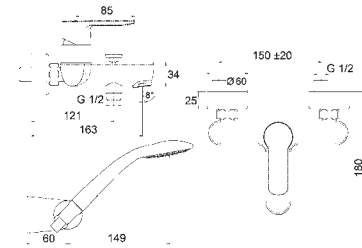

codice	UM	min. ord.	conf.	cat.	prezzo (€)
● 3008007	NR	1	8	03	171,33

RUBINETTERIA BAGNO

Serie ZERO

La serie ZERO dispone di una particolare tecnologia per l'ottimizzazione dell'efficienza energetica:

LIMITATORE DI TEMPERATURA: permette di decidere la temperatura massima dell'acqua.

REGOLATORE DINAMICO DI PORTATA: blocca l'alzata della leva al raggiungimento della metà della portata, riducendo il consumo del 50% (Escluso 3008802)

CARTUCCIA D. 35 mm A IMMERSIONE TOTALE: diminuisce l'usura meccanica della cartuccia.

LAVABO



Aeratore a scomparsa,
Scarico 1"1/4

RICAMBI (PAG. 60-75)
3008906 - Cartuccia
2751060 - Aeratore

codice	UM	min. ord.	conf.	cat.	prezzo (€)
● 3008801	NR	1	10	03	86,64

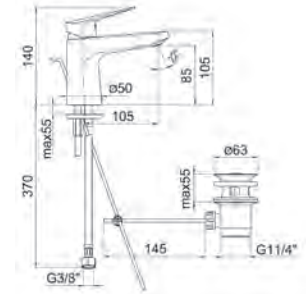

LAVABO LEVA CLINICA



Aeratore a scomparsa,
Scarico 1"1/4

RICAMBI (PAG. 60-75)
3008901 - Leva clinica
3008915 - Cartuccia
2751060 - Aeratore

codice	UM	min. ord.	conf.	cat.	prezzo (€)
● 3008802	NR	1	10	03	115,98

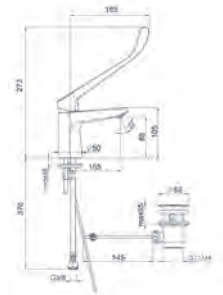

BIDET



Scarico 1"1/4

RICAMBI (PAG. 60-75)
3008906 - Cartuccia
2751204 - Aeratore cachè

codice	UM	min. ord.	conf.	cat.	prezzo (€)
● 3008803	NR	1	10	03	86,64

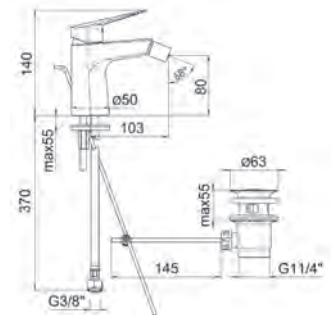

DOCCIA INCASSO CON DEVIATORE



Incluso corpo incasso

RICAMBI (PAG. 60-75)
3008904 - Cartuccia
3008910 - Deviatore
3008918 - Prolunga

codice	UM	min. ord.	conf.	cat.	prezzo (€)
● 3008805	NR	1	8	03	124,86

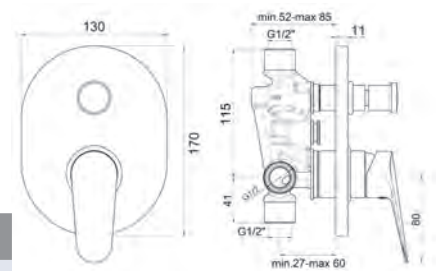

DOCCIA INCASSO

Incluso corpo incasso



RICAMBI (PAG. 60-75)
 3008904 - Cartuccia
 3008919 - Prolunga

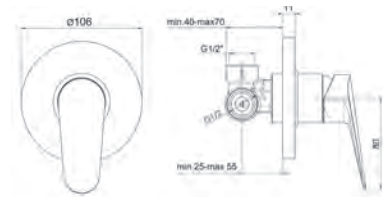

codice	UM	min. ord.	conf.	cat.	prezzo (€)
● 3008804	NR	1	30	03	67,17

DOCCIA ESTERNO



RICAMBI (PAG. 60-75)
 3008904 - Cartuccia

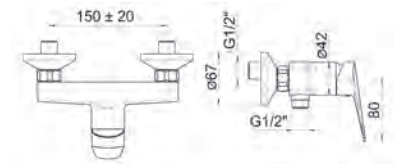

codice	UM	min. ord.	conf.	cat.	prezzo (€)
● 3008806	NR	1	20	03	97,17

VASCA CON KIT DOCCIA

Flessibile cm 150



RICAMBI (PAG. 60-75)
 3008906 - Cartuccia

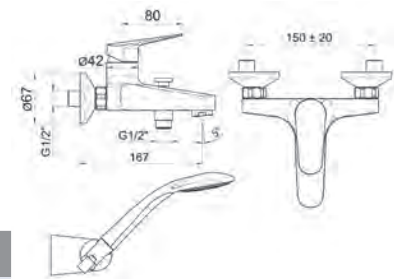

codice	UM	min. ord.	conf.	cat.	prezzo (€)
● 3008807	NR	1	8	03	127,89

RUBINETTERIA BAGNO

Serie NEMO

La serie NEMO dispone di una cartuccia da 35 mm.

LAVABO



Scarico 1"1/4

RICAMBI (PAG. 60-75)

3101075 - Maniglia

3101074 - Cartuccia

codice	UM	min. ord.	conf.	cat.	prezzo (€)
● 3003010	NR	1	10	03	80,67

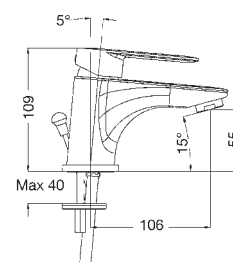

LAVABO LEVA CLINICA



Scarico 1"1/4

RICAMBI (PAG. 60-75)

3101070 - Leva clinica

3101074 - Cartuccia

codice	UM	min. ord.	conf.	cat.	prezzo (€)
● 3003019	NR	1	10	03	91,82

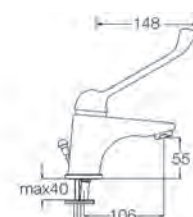

LAVABO "BIG SIZE"



Scarico 1"1/4

RICAMBI (PAG. 60-75)

3101075 - Maniglia

3101074 - Cartuccia

codice	UM	min. ord.	conf.	cat.	prezzo (€)
● 3003011	NR	1	10	03	86,59

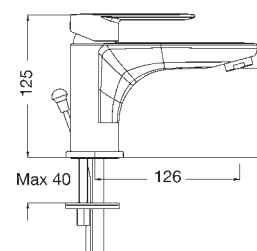

BIDET



Scarico 1"1/4

RICAMBI (PAG. 60-75)

3101075 - Maniglia

3101074 - Cartuccia

codice	UM	min. ord.	conf.	cat.	prezzo (€)
● 3003012	NR	1	10	03	82,53

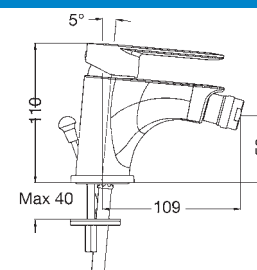

BIDET "BIG SIZE"



Scarico 1"1/4

RICAMBI (PAG. 60-75)

3101075 - Maniglia

3101074 - Cartuccia

2751200 - Aeratore cachè

codice	UM	min. ord.	conf.	cat.	prezzo (€)
● 3003020	NR	1	10	03	86,59

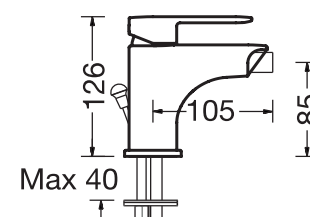

DOCCIA INCASSO CON DEVIATORE



Incluso corpo incasso

RICAMBI (PAG. 60-75)
 3101075 - Maniglia
 3101076 - Cartuccia

codice	UM	min. ord.	conf.	cat.	prezzo (€)
● 3003013	NR	1	14	03	126,38

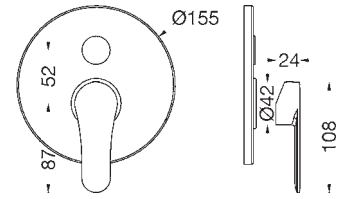

DOCCIA INCASSO



Incluso corpo incasso

RICAMBI (PAG. 60-75)
 3101075 - Maniglia
 3101076 - Cartuccia
 3101081 - Placca

codice	UM	min. ord.	conf.	cat.	prezzo (€)
● 3003014	NR	1	22	03	55,76

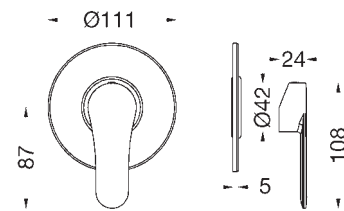

DOCCIA ESTERNO



RICAMBI (PAG. 60-75)
 3101075 - Maniglia
 3101074 - Cartuccia

codice	UM	min. ord.	conf.	cat.	prezzo (€)
● 3003015	NR	1	14	03	78,06

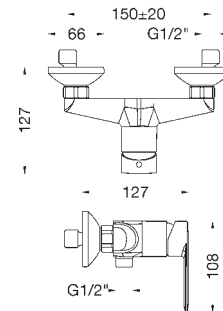

VASCA CON KIT DOCCIA

Flessibile cm. 150



RICAMBI (PAG. 60-75)
 3101075 - Maniglia
 3101074 - Cartuccia

codice	UM	min. ord.	conf.	cat.	prezzo (€)
● 3003016	NR	1	6	03	115,23

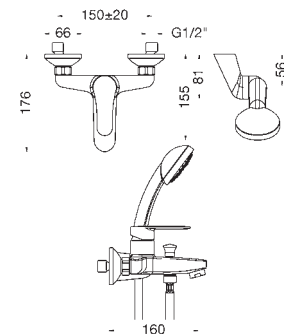

RUBINETTERIA BAGNO

Serie DELFINO DUE

La serie DELFINO DUE dispone di una cartuccia da 40 mm.

LAVABO



Scarico 1"1/4

RICAMBI (PAG. 60-75)

3101064 - Maniglia
3101060 - Cartuccia

codice	UM	min. ord.	conf.	cat.	prezzo (€)
● 3004001	NR	1	10	03	87,52

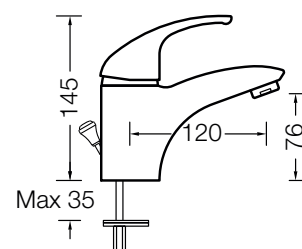

LAVABO LEVA CLINICA



Scarico 1"1/4

RICAMBI (PAG. 60-75)

3101004 - Leva clinica
3101060 - Cartuccia

codice	UM	min. ord.	conf.	cat.	prezzo (€)
● 3004009	NR	1	10	03	102,10

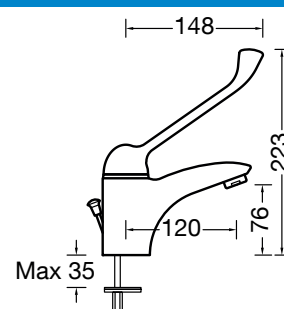

LAVABO BOCCA ESTRAIBILE



Scarico 1"1/4

RICAMBI (PAG. 60-75)

3101114 - Maniglia
3101112 - Cartuccia
3101096 - Bocca erogazione ABS
3101111 - Flessibile
3101004 - Leva clinica

codice	UM	min. ord.	conf.	cat.	prezzo (€)
● 3006001	NR	1	7	03	167,31

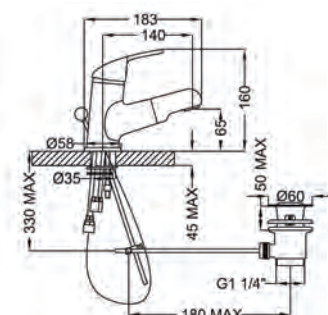

BIDET



Scarico 1"1/4

RICAMBI (PAG. 60-75)

3101064 - Maniglia
3101059 - Cartuccia

codice	UM	min. ord.	conf.	cat.	prezzo (€)
● 3004002	NR	1	10	03	87,52

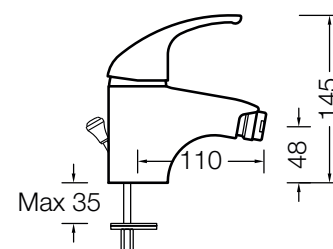

DOCCIA INCASSO CON DEVIATORE

Incluso corpo incasso



RICAMBI (PAG. 60-75)
 3101064 - Maniglia
 3101059 - Cartuccia

codice	UM	min. ord.	conf.	cat.	prezzo (€)
● 3004012	NR	1	14	03	182,49

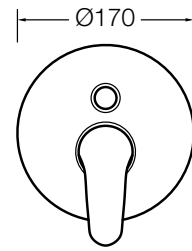

DOCCIA INCASSO

Incluso corpo incasso



RICAMBI (PAG. 60-75)
 3101064 - Maniglia
 3101059 - Cartuccia
 3101020 - Prolunga
 3101065 - Placca

codice	UM	min. ord.	conf.	cat.	prezzo (€)
● 3004003	NR	1	22	03	76,56

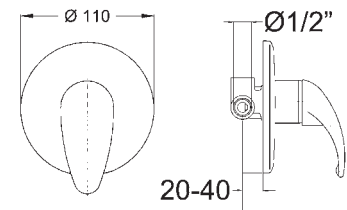

DOCCIA ESTERNO



RICAMBI (PAG. 60-75)
 3101064 - Maniglia
 3101059 - Cartuccia

codice	UM	min. ord.	conf.	cat.	prezzo (€)
● 3004004	NR	1	12	03	85,87

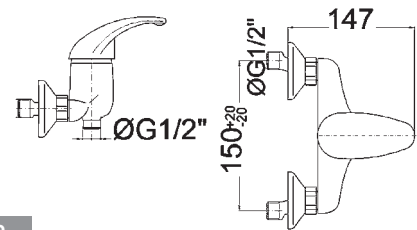

VASCA CON KIT DOCCIA

Flessibile cm. 150



RICAMBI (PAG. 60-75)
 3101064 - Maniglia
 3101059 - Cartuccia

codice	UM	min. ord.	conf.	cat.	prezzo (€)
● 3004005	NR	1	8	03	114,84

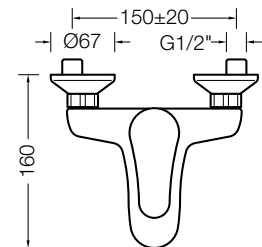

RUBINETTERIA BAGNO

Serie GROHE EUROSMART

LAVABO TAGLIA S

Scarico 1"1/4

5
l/min

codice	UM	min. ord.	conf.	cat.	prezzo [€]
● 33265003	NR	1	11	17	121,84

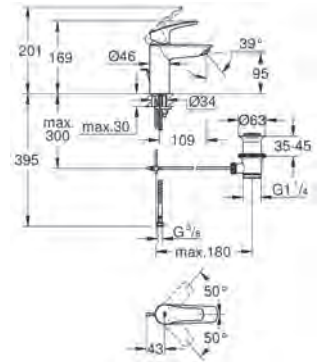

LAVABO BOCCA ALTA TAGLIA L

Scarico 1"1/4

5
l/min

codice	UM	min. ord.	conf.	cat.	prezzo [€]
● 23537003	NR	1	12	17	199,81

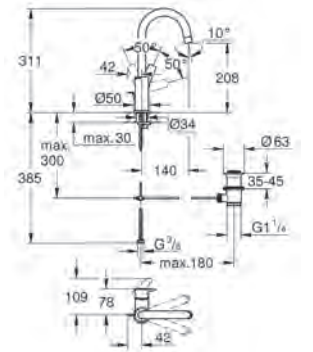

LAVABO TAGLIA M

Scarico 1"1/4

5
l/min

codice	UM	min. ord.	conf.	cat.	prezzo [€]
● 23322003	NR	1	11	17	139,46

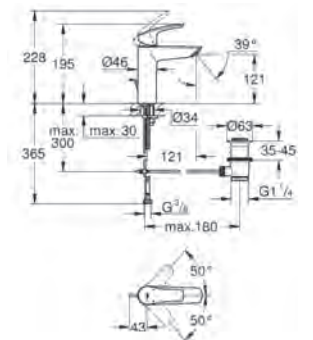

BIDET TAGLIA S

Scarico 1"1/4

5
l/min

codice	UM	min. ord.	conf.	cat.	prezzo [€]
● 32929003	NR	1	11	17	121,84

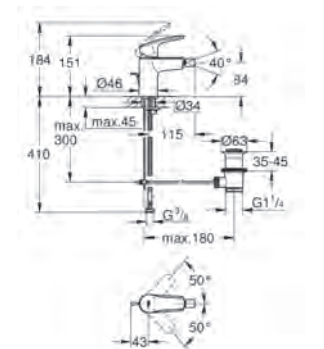

DOCCIA INCASSO CON DEVIATORE



Incluso corpo incasso

RICAMBI (PAG. 60-75)
46048000 - Cartuccia

codice	UM	min. ord.	conf.	cat.	prezzo (€)
● 33305003	NR	1	9	17	154,44

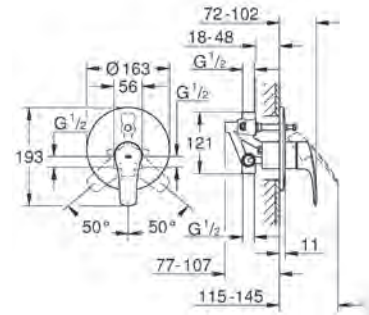

DOCCIA INCASSO



Incluso corpo incasso

RICAMBI (PAG. 60-75)
46048000 - Cartuccia

codice	UM	min. ord.	conf.	cat.	prezzo (€)
● 33556003	NR	1	9	17	128,28

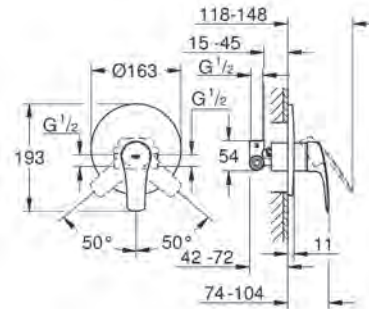

DOCCIA ESTERNO



RICAMBI (PAG. 60-75)
46374000 - Cartuccia

codice	UM	min. ord.	conf.	cat.	prezzo (€)
● 33555003	NR	1	12	17	133,46

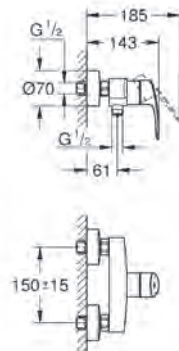

VASCA CON KIT DOCCIA

Flessibile cm. 150



RICAMBI (PAG. 60-75)
46374000 - Cartuccia

codice	UM	min. ord.	conf.	cat.	prezzo (€)
● 33302003	NR	1	9	17	200,56

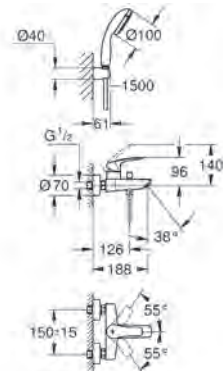

RUBINETTERIA BAGNO

Serie EVA

LAVABO MONOFORO

Scarico 1"1/4



RICAMBI (PAG. 60-75)
 3101057 - Maniglia
 3101032 - Vitone ceramico

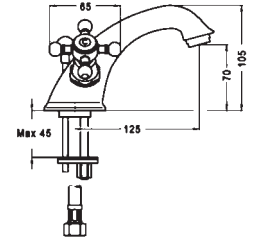

codice	UM	min. ord.	conf.	cat.	prezzo (€)
● 3007001	NR	1	8	05	160,48

LAVABO MONOFORO ALTO cm.11

Scarico 1"1/4



RICAMBI (PAG. 60-75)
 3101057 - Maniglia
 3101032 - Vitone ceramico

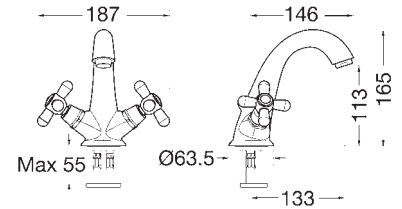

codice	UM	min. ord.	conf.	cat.	prezzo (€)
● 3007024	NR	1	1	05	211,55

LAVABO MONOFORO COLLO CIGNO

Scarico 1"1/4



RICAMBI (PAG. 60-75)
 3101057 - Maniglia
 3101032 - Vitone ceramico

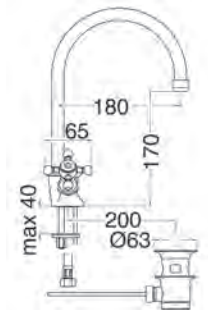

codice	UM	min. ord.	conf.	cat.	prezzo (€)
● 3007002	NR	1	8	05	156,40

LAVABO 3 FORI

Scarico 1"1/4



RICAMBI (PAG. 60-75)
 3101057 - Maniglia
 3101032 - Vitone ceramico

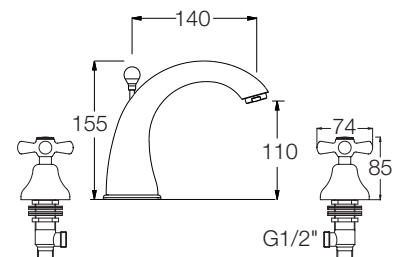

codice	UM	min. ord.	conf.	cat.	prezzo (€)
● 3007003	NR	1	8	05	260,83

LAVABO 3 FORI

Scarico 1"1/4



RICAMBI (PAG. 60-75)
 3101057 - Maniglia
 3101032 - Vitone ceramico

codice	UM	min. ord.	conf.	cat.	prezzo (€)
● 3007004	NR	1	8	05	260,83

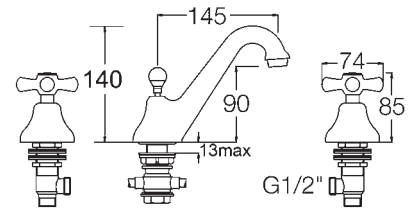

LAVABO 3 FORI COLLO CIGNO

Scarico 1"1/4



RICAMBI (PAG. 60-75)
 3101057 - Maniglia
 3101032 - Vitone ceramico

codice	UM	min. ord.	conf.	cat.	prezzo (€)
● 3007005	NR	1	8	05	213,99

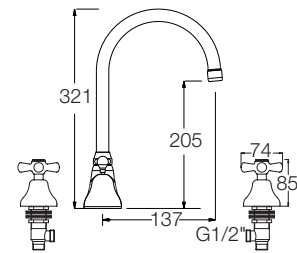

BIDET MONOFORO

Scarico 1"1/4



RICAMBI (PAG. 60-75)
 3101057 - Maniglia
 3101032 - Vitone ceramico

codice	UM	min. ord.	conf.	cat.	prezzo (€)
● 3007006	NR	1	8	05	160,48

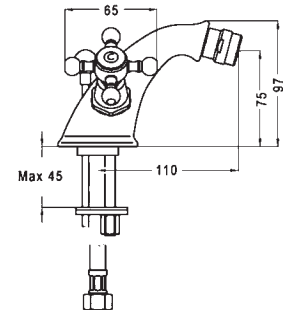

BIDET 3 FORI

Scarico 1"1/4



RICAMBI (PAG. 60-75)
 3101057 - Maniglia
 3101032 - Vitone ceramico

codice	UM	min. ord.	conf.	cat.	prezzo (€)
● 3007007	NR	1	10	05	143,15

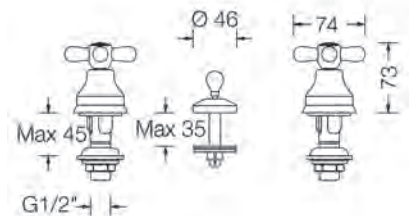

RUBINETTERIA BAGNO

Serie EVA

BIDET 3 FORI CON EROGAZIONE

Scarico 1"1/4



RICAMBI (PAG. 60-75)

3101057 - Maniglia

3101032 - Vitone ceramico

codice	UM	min. ord.	conf.	cat.	prezzo (€)
● 3007008	NR	1	1	05	260,83

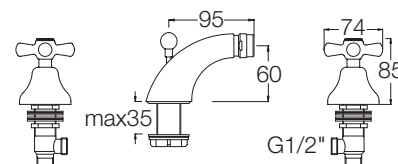

VASCA CON KIT DOCCIA

Flessibile cm. 150



RICAMBI (PAG. 60-75)

3101057 - Maniglia

3101032 - Vitone ceramico

1412003 - Doccetta

codice	UM	min. ord.	conf.	cat.	prezzo (€)
● 3007009	NR	1	8	05	222,71

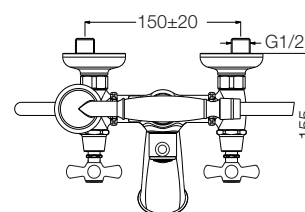

LAVABO MONOFORO

Scarico 1"1/4



RICAMBI (PAG. 60-75)
3101054 - Maniglia
3101031 - Vitone

codice	UM	min. ord.	conf.	cat.	prezzo (€)
● 3005001	NR	1	1	05	110,04

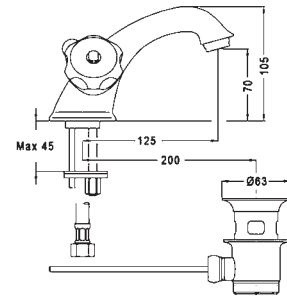

LAVABO 3 FORI

Scarico 1"1/4



RICAMBI (PAG. 60-75)
3101054 - Maniglia
3101031 - Vitone

codice	UM	min. ord.	conf.	cat.	prezzo (€)
● 3005008	NR	1	10	05	132,68

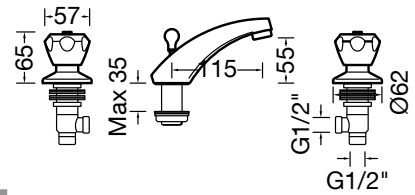

LAVABO 3 FORI SENZA SCARICO



RICAMBI (PAG. 60-75)
3101054 - Maniglia
3101031 - Vitone

codice	UM	min. ord.	conf.	cat.	prezzo (€)
● 3005020	NR	1	10	05	106,03

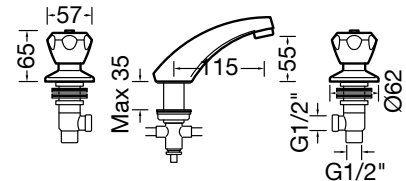

BIDET MONOFORO

Scarico 1"1/4



RICAMBI (PAG. 60-75)
3101054 - Maniglia
3101031 - Vitone

codice	UM	min. ord.	conf.	cat.	prezzo (€)
● 3005002	NR	1	1	05	110,04

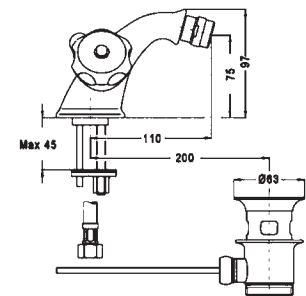

BIDET 3 FORI

Scarico 1"1/4



RICAMBI (PAG. 60-75)
3101054 - Maniglia
3101031 - Vitone

codice	UM	min. ord.	conf.	cat.	prezzo (€)
● 3005009	NR	1	10	05	87,47

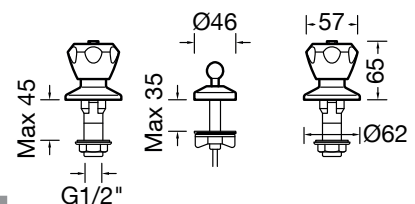

RUBINETTERIA BAGNO

Serie TRADIZIONALE

RUBINETTO BIDET



RICAMBI (PAG. 60-75)
3101054 - Maniglia
3101031 - Vitone

codice	UM	min. ord.	conf.	cat.	prezzo (€)
● 3005004	NR	2	44	05	32,73

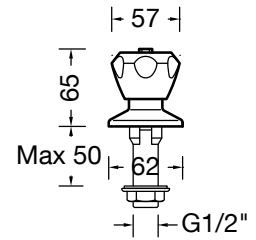

VASCA CON KIT DOCCIA



Flessibile cm. 150

RICAMBI (PAG. 60-75)
3101054 - Maniglia
3101031 - Vitone

codice	UM	min. ord.	conf.	cat.	prezzo (€)
● 3005003	NR	1	14	05	113,98

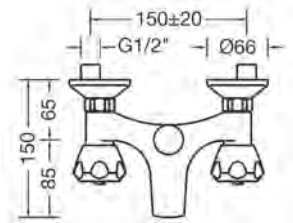

VASCA CON KIT DOCCIA



RICAMBI (PAG. 60-75)
3101054 - Maniglia
3101031 - Vitone

codice	UM	min. ord.	conf.	cat.	prezzo (€)
● 3005029	NR	1	1	05	113,98

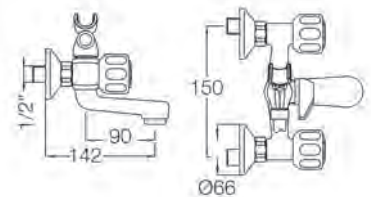

RUBINETTO PARETE



RICAMBI (PAG. 60-75)
3101054 - Maniglia
3101031 - Vitone

codice	UM	min. ord.	conf.	cat.	prezzo (€)
● 3005016	NR	2	44	05	39,61

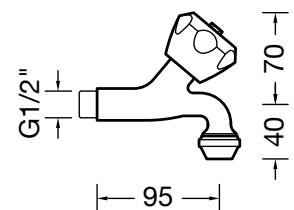

RUBINETTO EROGAZIONE SINGOLA D. 1/2"



RICAMBI (PAG. 60-75)
3101054 - Maniglia
3101031 - Vitone

codice	UM	min. ord.	conf.	cat.	prezzo (€)
● 3005021	NR	2	44	05	39,74

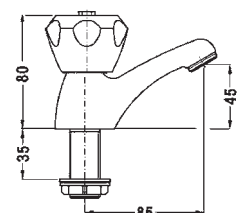

Serie TRADIZIONALE

RUBINETTO SINGOLO



RICAMBI (PAG. 60-75)
 3101054 - Maniglia
 3101031 - Vitone

codice	UM	min. ord.	conf.	cat.	prezzo (€)
● 3005026	NR	1	10	05	55,68

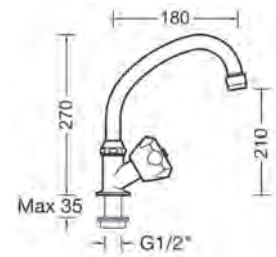

RUBINETTO INCASSO D. 1/2"



RICAMBI (PAG. 60-75)
 3101054 - Maniglia
 3101031 - Vitone

codice	UM	min. ord.	conf.	cat.	prezzo (€)
● 3005005	NR	2	44	05	38,15

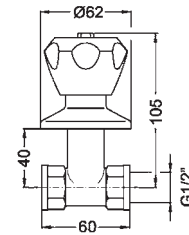

RUBINETTERIA ELETTRONICA

GROHE BAU COSMO E

Miscelatore elettronico con comando ad infrarossi e limitatore di temperatura regolabile, batteria litio 6V. Corpo in polimero composito.



codice	UM	min. ord.	conf.	cat.	prezzo (€)
● 36451000	NR	1	1	10	373,97

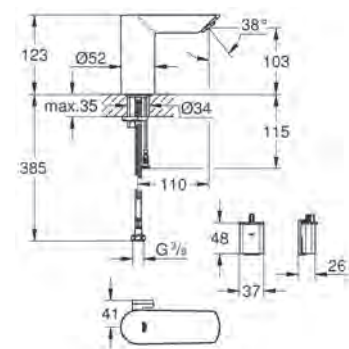

RUBINETTERIA BAGNO

CORPI INCASSO UNIVERSALI

GROHE RAPIDO SMARTBOX CORPO INCASSO UNIVERSALE



Per miscelatori Smartcontrol e per tutte le serie ad incasso Grohe.

codice	UM	min. ord.	conf.	cat.	prezzo (€)
● 35604000	NR	1	12	13	107,95

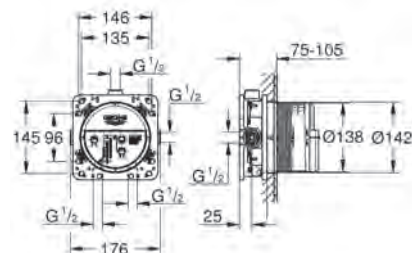

DADO/TONDA CORPO INCASSO 2 VIE

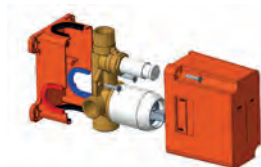

Con protezione.
Solo per la finitura cromo.

RICAMBI (PAG. 60-75)
3101098 - Cartuccia D.42

codice	UM	min. ord.	conf.	cat.	prezzo (€)
● 3005102	NR	1	1	03	108,60

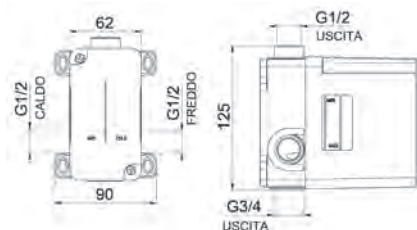

DADO/TONDA CORPO INCASSO 1 VIA

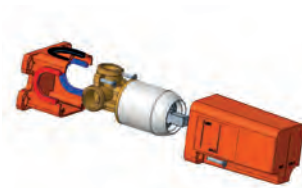

Con protezione.
Solo per la finitura cromo.

RICAMBI (PAG. 60-75)
3101098 - Cartuccia D.42

codice	UM	min. ord.	conf.	cat.	prezzo (€)
● 3005101	NR	1	1	03	53,76

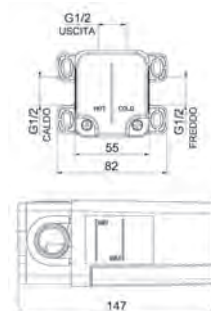

GROHE BLUE HOME STARTER KIT

Set composto da: miscelatore monocomando cromato per lavello con sistema filtrante dell'acqua, bocca girevole con angolo di rotazione 150° con n.2 canali di erogazione separati (uno per acqua corrente miscelata, uno per acqua filtrata), pulsante a pressione per 3 tipologie di acqua fresca e filtrata (acqua naturale fresca, leggermente frizzante e frizzante fresca).

Grohe Blue refrigeratore da 180 Watt, 230 V, 50 Hz.

Grohe Blue bombola CO2 da 425 gr.

Grohe Blue filtro BWT a 5 fasi con capacità media di 600 litri (40404001) oppure un anno di utilizzo: elimina le sostanze che alterano l'odore e il sapore dell'acqua (come il cloro e composti organici), riduce il calcare e diminuisce il residuo fisso.

Comunicazione dati wireless con Bluetooth 4.0 e interfaccia WIFI (per sistemi Apple e Android) per monitoraggio filtro e bombola di CO2.

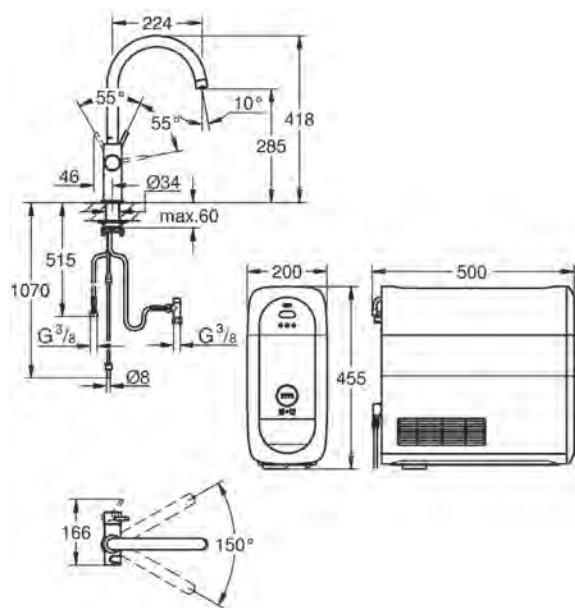

codice	UM	min. ord.	conf.	cat.	prezzo (€)
● 115556	NR	1	10	13	2697,57

GROHE BLUE FILTRO BWT



codice	capacità media	altezza (H)	UM	min. ord.	conf.	cat.	prezzo (€)
● 40404001	600 litri	234	NR	1	1	13	133,38
● 40430001	1.500 litri	315	NR	1	1	13	263,95

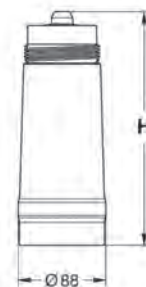

RUBINETTERIA CUCINA

FILTRAZIONE ACQUA POTABILE

KIT DELO' PUR CON MISCELATORE GIULIO

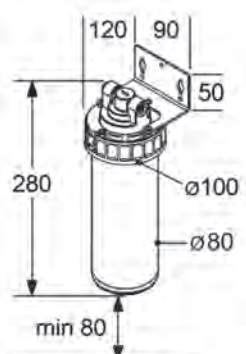
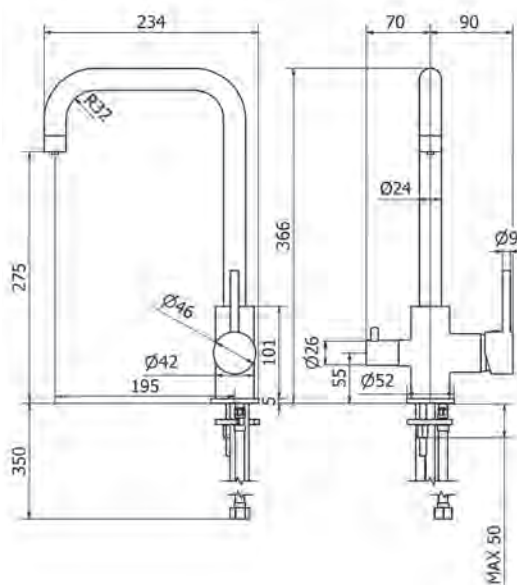

Sistema di filtrazione che rende gradevole l'acqua di casa.

La cartuccia permette una microfiltrazione meccanica e chimica di assorbimento tramite il sistema Carbon Block, per trattene impurità superiori a 0,5 µm.

Il sistema Carbon Block impregnato di sali d'argento impedisce a batteri e virus di proliferare all'interno del filtro.

Il kit Delò Pur trattiene:

- cloro e derivati
- sostanze organiche
- composti di metalli
- composti organo-alogenati

Il kit Delò Pur è composto da:

n.1 miscelatore GIULIO 3 acque (3001000), con due canali di erogazione separati e due maniglie (uno per l'acqua corrente, l'altro per l'acqua filtrata)

n.1 kit filtraggio (2006099) che comprende:

testata porta cartuccia con staffa e ghiera, cartuccia da 15.000 litri riferita a 1 ppm di cloro (2006098), 2,5 m di tubo da 8x6, valvola intercettazione acqua MF 3/8", raccordo di collegamento miscelatore sia da 3/8" che da 1/2", raccorderia per l'installazione.

Tecnologia conforme al D.M.174/4.

L'apparecchiatura deve essere installata nel rispetto delle norme locali vigenti e dal D.M. Salute 25/2012 e necessita di regolare manutenzione periodica per garantire i requisiti di potabilità (almeno una volta all'anno).

DATI TECNICI

Corpo del filtro	polipropilene
Autonomia cartuccia	15.000 lt/anno
Portata a 0,2 bar	4 lt/min.
Portata max	6 lt/min.
PN	8,6 bar
Filtrazione	0,5 µm
Temperatura max	39°C

COMPOSIZIONE

					420,50
codice	descrizione	UM	min. ord. conf.	cat.	prezzo (€)
● 3001000	GIULIO miscelatore	NR	1	11	167,85
● 2006099	Kit filtraggio	NR	1	11	252,65

KIT DELO' PUR CON MISCELATORE MARIO

Sistema di filtrazione che rende gradevole l'acqua di casa.

La cartuccia permette una microfiltrazione meccanica e chimica di assorbimento tramite il sistema Carbon Block, per trattenere impurità superiori a 0,5 µm.

Il sistema Carbon Block impregnato di sali d'argento impedisce a batteri e virus di proliferare all'interno del filtro.

Il kit Delò Pur trattiene:

- cloro e derivati
- sostanze organiche
- composti di metalli
- composti organo-alogenati

Il kit Delò Pur è composto da:

n.1 miscelatore MARIO 3 acque (3008855), con due canali di erogazione separati e due maniglie (uno per l'acqua corrente, l'altro per l'acqua filtrata)

n.1 kit filtraggio (2006099) che comprende:

testata porta cartuccia con staffa e ghiera, cartuccia da 15.000 litri riferita a 1 ppm di cloro (2006098), 2,5 m di tubo da 8x6, valvola intercettazione acqua MF 3/8", raccordo di collegamento miscelatore sia da 3/8" che da 1/2", raccorderia per l'installazione.

Tecnologia conforme al D.M.174/4.

L'apparecchiatura deve essere installata nel rispetto delle norme locali vigenti e dal D.M. Salute 25/2012 e necessita di regolare manutenzione periodica per garantire i requisiti di potabilità (almeno una volta all'anno).

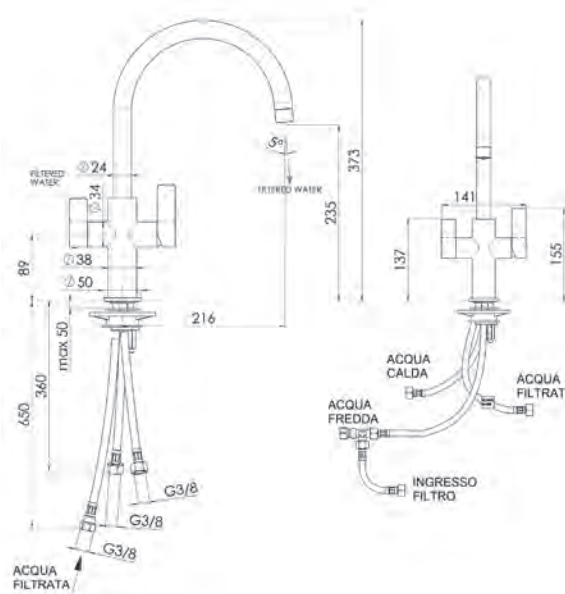

DATI TECNICI	
Corpo del filtro	polipropilene
Autonomia cartuccia	15.000 lt/anno
Portata a 0,2 bar	4 lt/min.
Portata max	6 lt/min.
PN	8,6 bar
Filtrazione	0,5 µm
Temperatura max	39°C

COMPOSIZIONE						504,78
codice	descrizione	UM	min. ord. conf.	cat.	prezzo (€)	
● 3008855	MARIO miscelatore	NR	1	11	252,13	
● 2006099	Kit filtraggio	NR	1	11	252,65	

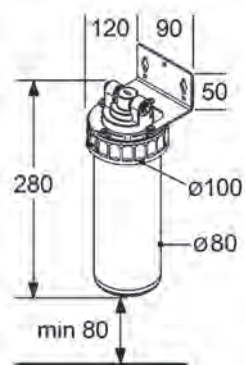

RUBINETTERIA CUCINA

FILTRAZIONE ACQUA POTABILE

CARTUCCIA PER KIT DELO' PUR

Capacità 15.000 litri/anno.

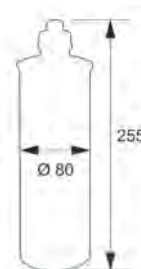

codice	descrizione	UM	min. ord.	conf.	cat.	prezzo (€)
● 2006098	cartuccia di ricambio	NR	1	6	03	99,00

CONTALITRI DIGIFLOW PER KIT DELO' PUR

Per Kit Delo' Pur (2006099), fissaggio con biadesivo, alimentazione a batterie AAA a corredo.

Da completare con nr.2 raccordi maschio 3/8"x8 (2006092) non a corredo.

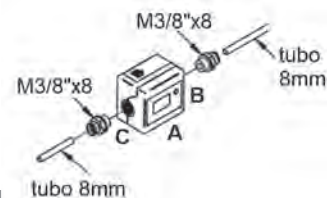

codice	AxBxC (cm)	UM	min. ord.	conf.	cat.	prezzo (€)
● 2006091	7,35x6,95x5,2	NR	1	1	03	104,46

RACCORDO PER CONTALITRI DIGIFLOW

A completamento contalitri 2006091. Serraggio max 3 Nm.



codice	Ø	UM	min. ord.	conf.	cat.	prezzo (€)
● 2006092	3/8" x 8mm	NR	2	2	03	5,01

GROHE BLUE PURE NEW BAUCURVE STARTER KIT

Set composto da: miscelatore monocomando cromato per lavello con sistema filtrante dell'acqua, maniglia separata per l'erogazione dell'acqua filtrata, bocca girevole con angolo di rotazione 150°. N.2 canali di erogazione separati (uno per acqua corrente miscelata, uno per acqua filtrata), Grohe Blue filtro BWT a 5 fasi con capacità media di 600 litri (40404001) oppure un anno di utilizzo. Elimina le sostanze che alterano l'odore e il sapore dell'acqua (come il cloro e composti organici), riduce il calcare e diminuisce il residuo fisso. Contalibri con allarme acustico per cambio filtro.

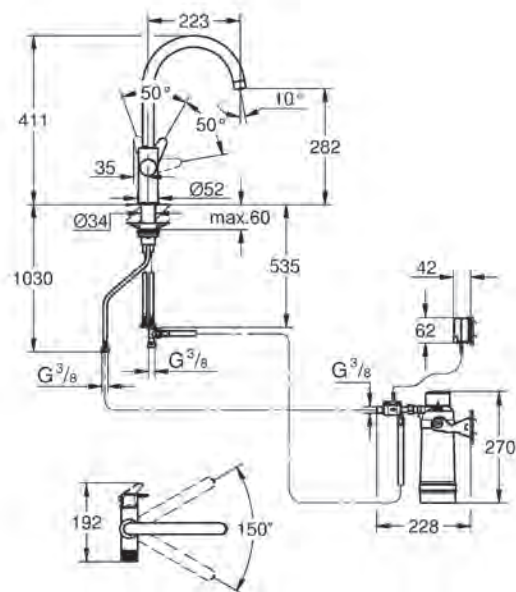

codice	UM	min. ord.	conf.	cat.	prezzo (€)
● 30581000	NR	1	6	13	545,54

GROHE BLUE FILTRO BWT



codice	capacità media	altezza (H)	UM	min. ord.	conf.	cat.	prezzo (€)
● 40404001	600 litri	234	NR	1	1	13	133,38
● 40430001	1.500 litri	315	NR	1	1	13	263,95

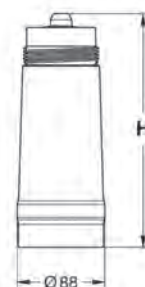

RUBINETTERIA CUCINA

RUBINETTERIA DA CUCINA

AMEDEO LEVELLO CON CANNA FLESSIBILE GOMMA NERA



Canna flessibile da 500 mm., D.20,5 mm., composta da: flessibile interno in PVC, maglia in acciaio e rivestimento esterno in silicone.

RICAMBI (PAG. 60-75)

3101110 - Bocca erogazione (versione cromo)

3101150 - Cartuccia D. 35

2751060 - Aeratore

codice	finitura corpo	UM	min. ord.	conf.	cat.	prezzo (€)
● 3005050	cromo	NR	1	5	03	171,99
● 3005950	nero opaco	NR	1	5	03	219,18

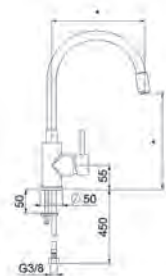

* MISURE VARIABILI

AMEDEO LEVELLO CON CANNA FLESSIBILE GOMMA BIANCA



Canna flessibile da 500 mm., D.20,5 mm., composta da: flessibile interno in PVC, maglia in acciaio e rivestimento esterno in silicone.

RICAMBI (PAG. 60-75)

3101109 - Bocca erogazione (versione cromo)

3101150 - Cartuccia D. 35

2751060 - Aeratore

codice	finitura corpo	UM	min. ord.	conf.	cat.	prezzo (€)
● 3005051	cromo	NR	1	5	03	171,99
● 3005751	bianco opaco	NR	1	5	03	219,18

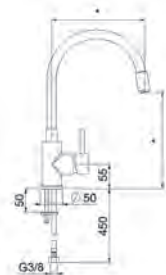

* MISURE VARIABILI

MARIO LEVELLO 3 ACQUE



Con deviatore per acqua filtrata, uscita separata.

RICAMBI (PAG. 60-75)

3008921 - Cartuccia D. 28

codice	UM	min. ord.	conf.	cat.	prezzo (€)
● 3008855	NR	1	30	11	252,13

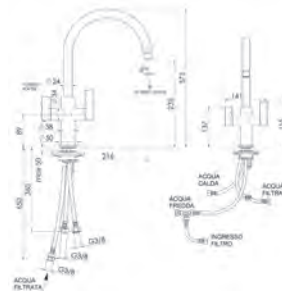

GIULIO LEVELLO 3 ACQUE



Con deviatore per acqua filtrata, uscita separata.

RICAMBI (PAG. 60-75)

3101115 - Maniglia

3101113 - Cartuccia D. 35

3101120 - Aeratore cachè

codice	UM	min. ord.	conf.	cat.	prezzo (€)
● 3001000	NR	1	5	11	167,85

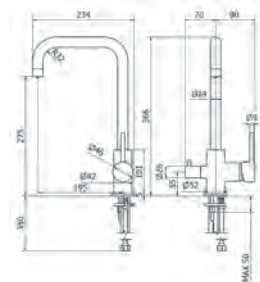

LEVELLO SOTTOFINESTRA



Altezza minima 8 cm.

RICAMBI (PAG. 60-75)

3101116 - Maniglia

3101112 - Cartuccia D. 40

codice	UM	min. ord.	conf.	cat.	prezzo (€)
● 1434001	NR	1	6	03	201,24

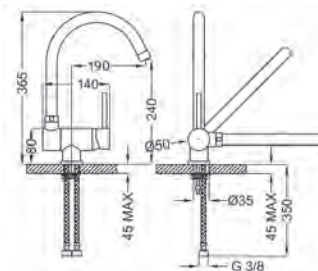

RUBINETTERIA DA CUCINA

EDO LAVELLO DOCCETTA ESTRAIBILE 2 GETTI



Molla fissa, doccetta estraibile.

RICAMBI (PAG. 60-75)
3101069 - Cartuccia D. 35

codice	UM	min. ord.	conf.	cat.	prezzo (€)
● 3009015	NR	1	4	03	307,56

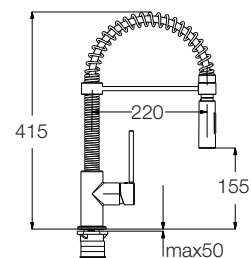

MAYA LAVELLO DOCCETTA ORIENTABILE 2 GETTI



Sganciando la doccetta dal supporto si utilizza la flessibilità della molla

RICAMBI (PAG. 60-75)
3008913 - Maniglia
3008905 - Cartuccia D. 35
3008911 - Doccetta (2 getti c/ritorno automatico)

codice	UM	min. ord.	conf.	cat.	prezzo (€)
● 3008034	NR	1	6	03	290,04

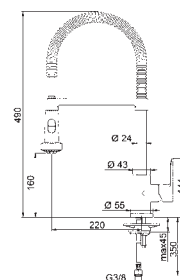

LAVELLO DOCCETTA ESTRAIBILE 2 GETTI



RICAMBI (PAG. 60-75)
3101114 - Maniglia
3101112 - Cartuccia D. 40
1413028 - Doccetta
3101111 - Flessibile

codice	UM	min. ord.	conf.	cat.	prezzo (€)
● 1434007	NR	1	7	03	120,00

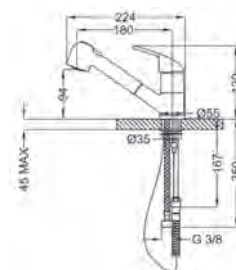

TONDA LAVELLO COLLO CIGNO



RICAMBI (PAG. 60-75)
3101150 - Cartuccia D. 35
3101138 - Bocca erogazione



codice	finitura	UM	min. ord.	conf.	cat.	prezzo (€)
● 3021025	cromo	NR	1	5	03	134,49
● 3021925	nero opaco	NR	1	5	03	169,41
● 3021825	simil acciaio	NR	1	5	03	199,62

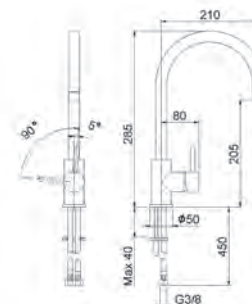

ZERO LAVELLO PIEGA TONDA



RICAMBI (PAG. 60-75)
3008905 - Cartuccia D. 35

codice	UM	min. ord.	conf.	cat.	prezzo (€)
● 3008810	NR	1	10	03	108,42

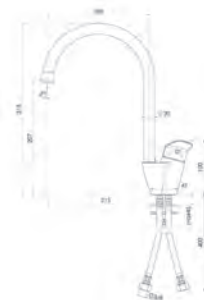

RUBINETTERIA CUCINA

RUBINETTERIA DA CUCINA

MAYA LEVELLO COLLO CIGNO



RICAMBI (PAG. 60-75)
 3008913 - Maniglia
 3008905 - Cartuccia D. 35

codice	UM	min. ord.	conf.	cat.	prezzo (€)
● 3008032	NR	1	6	03	159,51

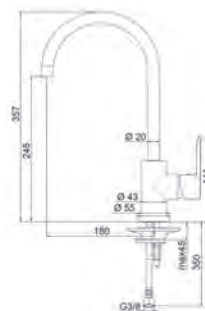

GROHE EUROSMART LEVELLO COLLO CIGNO



RICAMBI (PAG. 60-75)
 46374000 - Cartuccia D. 35

codice	UM	min. ord.	conf.	cat.	prezzo (€)
● 33202003	NR	1	12	17	164,94

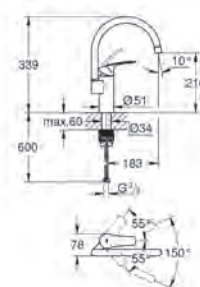

GROHE BAUEDGE LEVELLO BOCCA GIREVOLE



codice	UM	min. ord.	conf.	cat.	prezzo (€)
● 31367001	NR	1	12	11	165,01

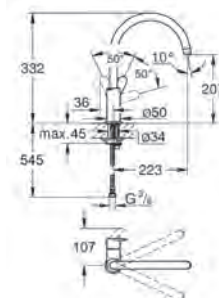

EVA LEVELLO MONOFORO COLLO CIGNO



RICAMBI (PAG. 60-75)
 3101057 - Maniglia
 3101032 - Vitone
 3101084 - Bocca erogazione

codice	UM	min. ord.	conf.	cat.	prezzo (€)
● 3007018	NR	1	8	05	121,73

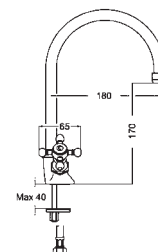

TRADIZIONALE LEVELLO MONOFORO COLLO CIGNO



RICAMBI (PAG. 60-75)
 3101054 - Maniglia
 3101031 - Vitone

codice	UM	min. ord.	conf.	cat.	prezzo (€)
● 3005012	NR	1	10	05	71,57

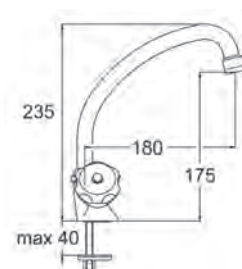

PIETRO LAVELLO BOCCA GIREVOLE



RICAMBI (PAG. 60-75)
3101069 - Cartuccia

codice	UM	min. ord.	conf.	cat.	prezzo (€)
● 1434013	NR	1	1	03	235,42

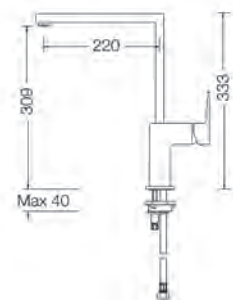

TONDA LAVELLO BOCCA GIREVOLE



RICAMBI (PAG. 60-75)
3101150 - Cartuccia D. 35



codice	finitura	UM	min. ord.	conf.	cat.	prezzo (€)
● 3021023	cromo	NR	1	5	03	144,45
● 3021923	nero opaco	NR	1	5	03	169,41
● 3021823	simil acciaio	NR	1	5	03	207,21

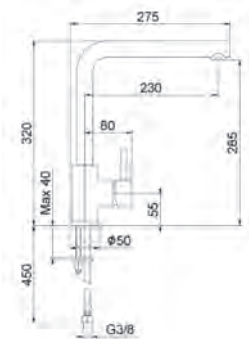

TONDA LAVELLO DOCCETTA ESTRAIBILE 1 GETTO



RICAMBI (PAG. 60-75)
3101150 - Cartuccia D. 35



codice	finitura	UM	min. ord.	conf.	cat.	prezzo (€)
● 3021024	cromo	NR	1	5	03	158,91
● 3021924	nero opaco	NR	1	5	03	193,56
● 3021824	simil acciaio	NR	1	5	03	225,33

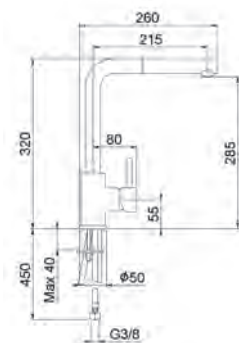

MAYA LAVELLO BOCCA GIREVOLE



RICAMBI (PAG. 60-75)
3008913 - Maniglia
3008905 - Cartuccia D. 35

codice	UM	min. ord.	conf.	cat.	prezzo (€)
● 3008033	NR	1	6	03	159,51

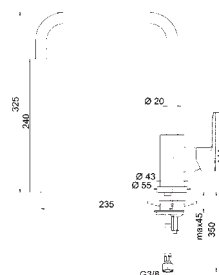

RUBINETTERIA CUCINA

RUBINETTERIA DA CUCINA

ELIO LAVELLO PIEGA TONDA



RICAMBI (PAG. 60-75)
3008922 - Maniglia
3008920 - Cartuccia

codice	UM	min. ord.	conf.	cat.	prezzo (€)
● 3008850	NR	1	10	03	97,35

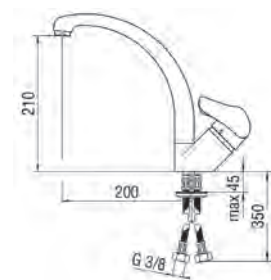

DELFINO DUE LAVELLO PIEGA TONDA



RICAMBI (PAG. 60-75)
3101064 - Maniglia
3101059 - Cartuccia
3101090 - Bocca erogazione

codice	UM	min. ord.	conf.	cat.	prezzo (€)
● 3004010	NR	1	10	03	94,68

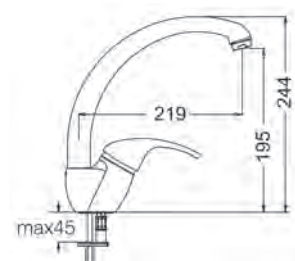

ZERO LAVELLO BOCCA GIREVOLE



RICAMBI (PAG. 60-75)
3008904 - Cartuccia
2751060 - Aeratore

codice	UM	min. ord.	conf.	cat.	prezzo (€)
● 3008808	NR	1	10	03	92,28

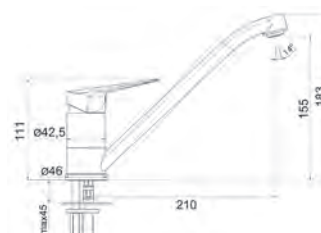

DELFINO DUE LAVELLO



RICAMBI (PAG. 60-75)
3101064 - Maniglia
3101059 - Cartuccia

codice	UM	min. ord.	conf.	cat.	prezzo (€)
● 3004006	NR	1	10	03	78,22

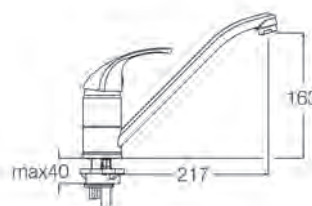

RUBINETTERIA DA CUCINA

ZERO LIVELLO A PARETE



RICAMBI (PAG. 60-75)
3008904 - Cartuccia
2751060 - Aeratore

codice	UM	min. ord.	conf.	cat.	prezzo (€)
● 3008809	NR	1	20	03	122,07

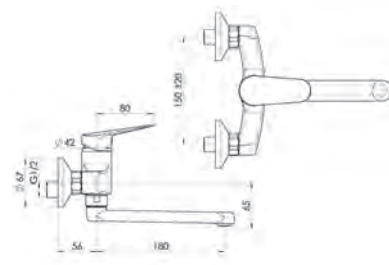

DELFINO DUE LIVELLO PARETE



RICAMBI (PAG. 60-75)
3101064 - Maniglia
3101059 - Cartuccia
3101038 - Bocca erogazione

codice	UM	min. ord.	conf.	cat.	prezzo (€)
● 3004008	NR	1	12	03	94,68

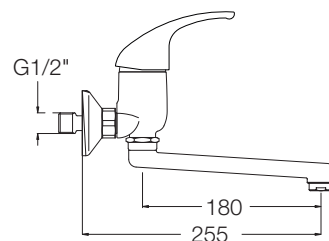

EVA LIVELLO PARETE



RICAMBI (PAG. 60-75)
3101057 - Maniglia
3101032 - Vitone

codice	UM	min. ord.	conf.	cat.	prezzo (€)
● 3007019	NR	1	12	05	119,08

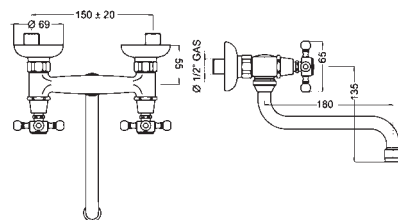

TRADIZIONALE LIVELLO PARETE



RICAMBI (PAG. 60-75)
3101054 - Maniglia
3101031 - Vitone

codice	UM	min. ord.	conf.	cat.	prezzo (€)
● 3005010	NR	1	20	05	77,93

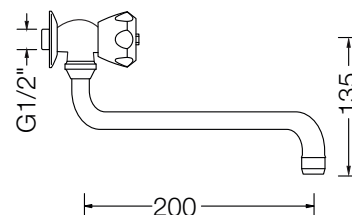

RUBINETTERIA CUCINA

RUBINETTERIA DA CUCINA

TRADIZIONALE LAVELLO PARETE BOCCA ALTA GIREVOLE



RICAMBI (PAG. 60-75)
3101054 - Maniglia
3101031 - Vitone

codice	UM	min. ord.	conf.	cat.	prezzo (€)
● 3005025	NR	1	10	05	74,68

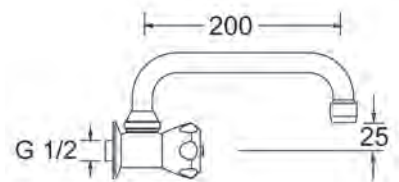

TRADIZIONALE LAVELLO PARETE CON DEVIATORE E ATTACCO LAVATRICE



RICAMBI (PAG. 60-75)
3101054 - Maniglia
3101031 - Vitone

codice	UM	min. ord.	conf.	cat.	prezzo (€)
● 3005027	NR	1	12	05	100,54

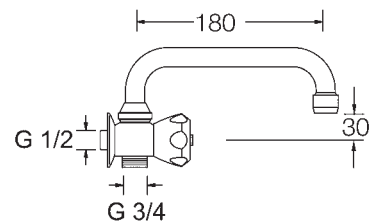

TRADIZIONALE RUBINETTO SINGOLO PARETE



RICAMBI (PAG. 60-75)
3101054 - Maniglia
3101031 - Vitone

codice	UM	min. ord.	conf.	cat.	prezzo (€)
● 3005014	NR	1	10	05	40,85

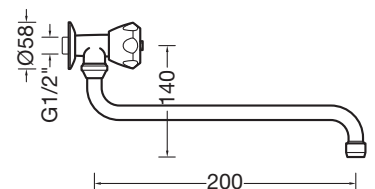

TRADIZIONALE RUBINETTO PER SCALDABAGNO

Incluso tubo di collegamento



codice	UM	min. ord.	conf.	cat.	prezzo (€)
● 3005028	NR	1	20	03	75,63

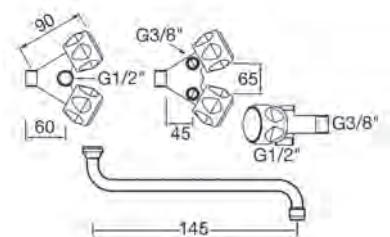

RUBINETTERIA CON LEVA CLINICA

ZERO LAVABO LEVA CLINICA

Scarico 1"1/4



RICAMBI (PAG. 60-75)
 3008901 - Leva clinica
 3008915 - Cartuccia
 2751060 - Aeratore

codice	UM	min. ord.	conf.	cat.	prezzo (€)
● 3008802	NR	1	10	03	115,98

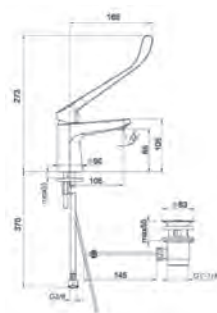

NEMO LAVABO LEVA CLINICA

Scarico 1"1/4



RICAMBI (PAG. 60-75)
 3101070 - Leva clinica
 3101074 - Cartuccia

codice	UM	min. ord.	conf.	cat.	prezzo (€)
● 3003019	NR	1	10	03	91,82

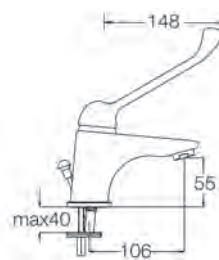

DELFINO DUE LAVABO LEVA CLINICA

Scarico 1"1/4



RICAMBI (PAG. 60-75)
 3101004 - Leva clinica
 3101060 - Cartuccia

codice	UM	min. ord.	conf.	cat.	prezzo (€)
● 3004009	NR	1	10	03	102,10

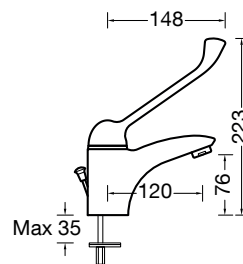

DELFINO UNO LAVELLO LEVA CLINICA



RICAMBI (PAG. 60-75)
 3101004 - Leva clinica
 3101006 - Cartuccia

codice	UM	min. ord.	conf.	cat.	prezzo (€)
● 3002014	NR	1	10	03	104,16

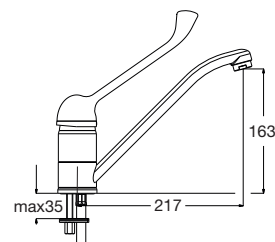

DELFINO UNO LAVELLO PARETE LEVA CLINICA



RICAMBI (PAG. 60-75)
 3101004 - Leva clinica
 3101006 - Cartuccia

codice	UM	min. ord.	conf.	cat.	prezzo (€)
● 3002013	NR	1	14	03	139,68

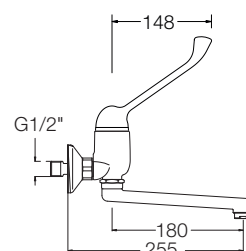

RICAMBI RUBINETTERIA

CARTUCCE E VITONI

DADO CARTUCCIA

Fondo piatto

Compatibilità:

3001010 Lavabo
 3001011 Lavabo alto
 3001027 Lavabo "Big Size"
 3001012 Bidet
 3001018 Doccia esterno
 3001017 Vasca con kit doccia



codice	Ø	UM	min. ord.	conf.	cat.	prezzo (€)
● 3101097	mm 25 x 47,5 H	NR	1	1	09	29,44

TONDA CARTUCCIA

Fondo piatto

Compatibilità:

3021020 Doccia esterno



codice	Ø	UM	min. ord.	conf.	cat.	prezzo (€)
● 3101099	mm 35 x 57 H	NR	1	1	09	12,72

TONDA CARTUCCIA

Fondo piatto

Compatibilità:

3021010 Lavabo
 3021026 Lavabo
 3021011 Lavabo alto
 3021012 Bidet
 3021027 Bidet



codice	Ø	UM	min. ord.	conf.	cat.	prezzo (€)
● 3101101	mm 35 x 58 H	NR	1	1	09	18,32

NEMO CARTUCCIA

Cartuccia Keramital con distribuzione

Compatibilità:

3003010 Lavabo
 3003019 Lavabo leva clinica
 3003011 Lavabo "big size"
 3003012 Bidet
 3003020 Bidet "big size"
 3003015 Doccia esterno
 3003016 Vasca con kit doccia
 1431015 Doccia esterno



codice	Ø	UM	min. ord.	conf.	cat.	prezzo (€)
● 3101074	mm 35 x 68,4 H	NR	1	20	09	16,90

DADO/TONDA CARTUCCIA

Fondo piatto

Compatibilità:

3001013 Lavabo parete
 3001014 Doccia incasso
 3001015 Doccia incasso con deviatore
 3001016 Doccia incasso 3 vie
 3021013 Lavabo parete 2 pezzi
 3021015 Doccia incasso
 3021016 Doccia incasso con deviatore
 3021018 Doccia incasso 3 vie
 3005101 Corpo incasso 1 via
 3005102 Corpo incasso 2 vie



codice	Ø	UM	min. ord.	conf.	cat.	prezzo (€)
● 3101098	mm 42 x 63 H	NR	1	1	09	12,72

DADO/TONDA CARTUCCIA

Fondo piatto

Compatibilità:

3021014 Lavabo parete piastra unica
 3021017 Doccia incasso c/deviatore 2 vie
 3021019 Vasca con kit doccia
 3001026 Vasca a pavimento



codice	Ø	UM	min. ord.	conf.	cat.	prezzo (€)
● 3101100	mm 35 x 56,5 H	NR	1	1	09	12,72

EDO / LOLA CARTUCCIA

Cartuccia Keramital con fondo piatto e ghiera di regolazione antiscottatura. Apertura 60° + 60°

Compatibilità:

1430007 Doccia esterno per colonne doccia
 3004108 Corpo incasso lavabo
 3004112 Corpo incasso doccia
 3004114 Corpo incasso doccia deviatore



codice	Ø	UM	min. ord.	conf.	cat.	prezzo (€)
● 3101042	mm 35 x 55,2 H	NR	1	1	09	28,20

EDO CARTUCCIA

Cartuccia Keramital con fondo piatto e ghiera di regolazione antiscottatura. Apertura 30° + 60°

Compatibilità:

3009015 Lavello con doccetta
 1434013 Lavello bocca girevole



codice	Ø	UM	min. ord.	conf.	cat.	prezzo (€)
● 3101069	mm 35 x 55,2 H	NR	1	1	09	31,77

CARTUCCE E VITONI

MAYA CARTUCCIA

Con distribuzione e limitatore di temperatura



Compatibilità:

- 3008001 Lavabo
- 3008010 Lavabo "Big size"
- 3008002 Lavabo corpo alto
- 3008003 Bidet

codice	∅	UM	min. ord.	conf.	cat.	prezzo (€)
● 3008908	mm 35 x 70,2 H	NR	1	1	02	63,85

MAYA/ZERO CARTUCCIA

Con distribuzione



Compatibilità:

- 3008802 Lavabo leva clinica

codice	∅	UM	min. ord.	conf.	cat.	prezzo (€)
● 3008915	mm 35 x 70 H	NR	1	1	02	65,89

MAYA/ZERO CARTUCCIA

Fondo piatto



Compatibilità:

- 3008004 Doccia incasso
- 3008005 Doccia esterno
- 3008006 Doccia incasso con deviatore
- 3008805 Doccia incasso con deviatore
- 3008804 Doccia incasso
- 3008806 Doccia esterno
- 3008808 Lavello bocca girevole
- 3008809 Lavello parete

codice	∅	UM	min. ord.	conf.	cat.	prezzo (€)
● 3008904	mm 35 x 57,2 H	NR	1	1	02	65,89

MAYA/ZERO CARTUCCIA

Con distribuzione, senza o-ring.



Compatibilità:

- 3008007 Vasca con kit doccia
- 3008032 Lavello collo cigno
- 3008033 Lavello bocca girevole
- 3008034 Lavello con doccetta
- 3008810 Lavello piega tonda

codice	∅	UM	min. ord.	conf.	cat.	prezzo (€)
● 3008905	mm 35 x 71,1 H	NR	1	1	02	65,89

MAYA/ZERO CARTUCCIA

Con distribuzione



Compatibilità:

- 3008009 Lavabo "Maniglia standard"
- 3008011 Lavabo "Maniglia standard"
- 3008012 Bidet
- 3008801 Lavabo
- 3008803 Bidet
- 3008807 Vasca con kit doccia

codice	∅	UM	min. ord.	conf.	cat.	prezzo (€)
● 3008906	mm 35 x 70 H	NR	1	1	02	65,89

DELFINO UNO CARTUCCIA

Cartuccia Keramital con distribuzione e ghiera di regolazione anticottatura



codice	∅	UM	min. ord.	conf.	cat.	prezzo (€)
● 3101005	mm 40 x 74,1 H	NR	1	20	09	31,77

LOLA CARTUCCIA

Con distribuzione



Compatibilità:

- 3004101 Lavabo
- 3004103 Lavabo "Big Size"
- 3004105 Lavabo alto
- 3004109 Bidet
- 3004115 Lavello

codice	∅	UM	min. ord.	conf.	cat.	prezzo (€)
● 3101147	mm 25 x 55 H	NR	1	1	09	64,68

DELFINO UNO CARTUCCIA

Cartuccia Keramital con fondo piatto e ghiera di regolazione anticottatura



Compatibilità:

- 3002014 Lavello leva clinica
- 3002013 Lavello parete leva clinica

codice	∅	UM	min. ord.	conf.	cat.	prezzo (€)
● 3101006	mm 40 x 61,7 H	NR	1	20	09	28,20

RICAMBI RUBINETTERIA

CARTUCCE E VITONI

DELFINO DUE CARTUCCIA

Cartuccia Keramital con fondo piatto

Compatibilità:

- 3004002 Bidet
- 3004012 Doccia incasso con deviatore
- 3004003 Doccia incasso
- 3004004 Doccia esterno
- 3004005 Vasca con kit doccia
- 3004010 Lavello piega tonda
- 3004006 Lavello
- 3004008 Lavello parete



codice	∅	UM	min. ord.	conf.	cat.	prezzo (€)
● 3101059	mm 40 x 61,6 H	NR	1	20	09	16,90

GROHE CARTUCCIA CERAMICA



codice	∅	UM	min. ord.	conf.	cat.	prezzo (€)
● 46580000	mm 28	NR	1	20	10	87,33

GROHE CARTUCCIA CERAMICA



codice	∅	UM	min. ord.	conf.	cat.	prezzo (€)
● 46048000	mm 46	NR	1	20	10	75,18

GIULIO CARTUCCIA



Compatibilità:

- 3001000 Lavello 3 acque

codice	∅	UM	min. ord.	conf.	cat.	prezzo (€)
● 3101113	mm 35 x 70 H	NR	1	1	02	46,55

MARIO CARTUCCIA



Compatibilità:

- 3008855 Lavello 3 acque

codice	∅	UM	min. ord.	conf.	cat.	prezzo (€)
● 3008921	mm 28 x 56 H	NR	1	1	02	65,89

DELFINO DUE CARTUCCIA

Cartuccia Keramital con distribuzione



Compatibilità:

- 3004001 Lavabo
- 3004009 Lavabo leva clinica

codice	∅	UM	min. ord.	conf.	cat.	prezzo (€)
● 3101060	mm 40 x 74,1 H	NR	1	20	09	16,90

GROHE CARTUCCIA CERAMICA



codice	∅	UM	min. ord.	conf.	cat.	prezzo (€)
● 46374000	mm 35	NR	1	20	10	76,97

CARTUCCIA



Compatibilità:

- 3006001 Lavabo bocca estraibile
- 1434001 Lavello sottofinestra
- 1434007 Lavello doccia estraibile

codice	∅	UM	min. ord.	conf.	cat.	prezzo (€)
● 3101112	mm 40 x 63 H	NR	1	1	02	46,55

ELIO CARTUCCIA

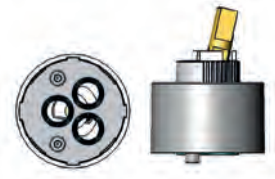

Compatibilità:

- 3008850 Lavello piega tonda

codice	∅	UM	min. ord.	conf.	cat.	prezzo (€)
● 3008920	mm 45 x 61 H	NR	1	1	02	69,26

AMEDEO/TONDA CARTUCCIA

Apertura 90° antioraria

NOVITÀ!



Compatibilità:

- 3005050 Lavello canna flessibile nera
- 3005051 Lavello canna flessibile bianca
- 3021023 Lavello bocca girevole
- 3021024 Lavello bocca doccia estraibile
- 3021025 Lavello collo cigno

codice	∅	UM	min. ord.	conf.	cat.	prezzo (€)
● 3101150	mm 35 x 58 H	NR	1	1	02	21,15

CARTUCCE E VITONI

CARTUCCIA DEVIATORE INCASSO 2 E 3 VIE

Cartuccia Keramital con fondo piatto



Compatibilità:

- 1431014 Deviatore incasso 2 vie
- 1431017 Deviatore incasso 3 vie

codice	∅	UM	min. ord.	conf.	cat.	prezzo (€)
● 3101072	mm 35 x 55,2 H	NR	1	1	09	38,10

NEMO CARTUCCIA

Cartuccia Keramital con fondo piatto



Compatibilità:

- 3003013 Doccia incasso con deviatore
- 3003014 Doccia incasso

codice	∅	UM	min. ord.	conf.	cat.	prezzo (€)
● 3101076	mm 35 x 55,2 H	NR	1	1	09	14,87

VITONE CERAMICO 90°



Compatibilità:

- Per tutta la Serie EVA
- 3001005 Termostatico Doccia esterno
- 1431024 Termostatico quadrato

codice	∅	UM	min. ord.	conf.	cat.	prezzo (€)
● 3101032	1/2"	NR	1	50	09	16,37

VITONE TRADIZIONALE / EVA



Compatibilità:

- Per tutta la Serie TRADIZIONALE e per serie EVA (non ceramico)

codice	∅	UM	min. ord.	conf.	cat.	prezzo (€)
● 3101031	1/2"	NR	1	10	09	11,40

GROHE VITONE



codice	∅	UM	min. ord.	conf.	cat.	prezzo (€)
● 07146000	1/2"	NR	1	1	10	18,00

GROHE VITONE

Per rubinetto ad incasso



codice	∅	UM	min. ord.	conf.	cat.	prezzo (€)
● 07147000	1/2"	NR	1	1	10	33,01

GROHE TESTINA DISCHI CERAMICI



codice	∅	UM	min. ord.	conf.	cat.	prezzo (€)
● 45346000	1/2"	NR	1	1	10	52,39

GROHE VITONE DISCHI CERAMICI



codice	∅	UM	min. ord.	conf.	cat.	prezzo (€)
● 45869000	1/2"	NR	1	1	10	54,21

RICAMBI RUBINETTERIA

CARTUCCE E VITONI

CARTUCCIA PER DEVIATORE



Compatibilità:
1350902 Colonna multifunzione IRIDE

codice	∅	UM	min. ord.	conf.	cat.	prezzo (€)
● 1413084	mm 32	NR	1	10	09	23,64

CARTUCCIA PER RUBINETTO



Compatibilità:
Per tutte le colonne multifunzione

codice	∅	UM	min. ord.	conf.	cat.	prezzo (€)
● 1413085	mm 40	NR	1	10	09	8,84

CARTUCCIA PER DEVIATORE



Compatibilità:
1350903 Colonna multifunzione SELENE BIANCA
1350912 Colonna multifunzione SELENE NERA
1350913 Colonna multifunzione AURORA

codice	∅	UM	min. ord.	conf.	cat.	prezzo (€)
● 1413086	mm 35	NR	1	10	09	24,84

CARTUCCIA PER DEVIATORE



Compatibilità:
1350907 Colonna multifunzione FLORA
1350917 Colonna multifunzione DIANA

codice	∅	UM	min. ord.	conf.	cat.	prezzo (€)
● 1413091	mm 35	NR	1	10	09	31,52

CARTUCCIA PER DEVIATORE



Compatibilità:
1350908 Colonna multifunzione ATENA

codice	∅	UM	min. ord.	conf.	cat.	prezzo (€)
● 1413089	mm 33	NR	1	10	09	31,52

CARTUCCIA PER DEVIATORE



Compatibilità:
1414009 Deviatore colonna

codice	∅	UM	min. ord.	conf.	cat.	prezzo (€)
● 1406030	mm 22	NR	1	1	09	21,16

CARTUCCIA PER DEVIATORE

NOVITÀ!



Compatibilità:
1350918 Colonna multifunzione MINERVA

codice	∅	UM	min. ord.	conf.	cat.	prezzo (€)
● 1413095	mm 33	NR	1	10	09	19,00

CARTUCCE E VITONI PER TERMOSTATICO

CARTUCCIA TERMOSTATICA INCASSO TONDO/QUADRO



Compatibilità:

- 3012002 Termostatico 2 vie
- 3012003 Termostatico 3 vie
- 3013002 Termostatico 2 vie
- 3013003 Termostatico 3 vie

codice	∅	UM	min. ord.	conf.	cat.	prezzo (€)
● 3101230	mm 34	NR	1	1	02	44,23

CARTUCCIA TERMOSTATICA



Compatibilità:

- 1431016 Termostatico tondo (solo cromo)
- 1431018 Termostatico tondo (solo cromo)

codice	∅	UM	min. ord.	conf.	cat.	prezzo (€)
● 3101077	mm 31	NR	1	1	06	87,60

CARTUCCIA TERMOSTATICA



Compatibilità:

- 3001005 Termostatico doccia esterno

codice	∅	UM	min. ord.	conf.	cat.	prezzo (€)
● 3101061	mm 40	NR	1	1	06	59,04

CARTUCCIA TERMOSTATICA



Compatibilità:

- 1431024 Termostatico quadrato

codice	∅	UM	min. ord.	conf.	cat.	prezzo (€)
● 3101117	mm 40	NR	1	1	06	62,85

CARTUCCIA TERMOSTATICA



Compatibilità:

- 1431021 Termostatico esterno

codice	∅	UM	min. ord.	conf.	cat.	prezzo (€)
● 3101088	mm 40	NR	1	1	06	59,04

CARTUCCIA DEVIATRICE



Compatibilità:

- 1431021 Termostatico esterno

codice	∅	UM	min. ord.	conf.	cat.	prezzo (€)
● 3101089	mm 35	NR	1	1	06	66,69

GROHE TERMOELEMENTO



codice	∅	UM	min. ord.	conf.	cat.	prezzo (€)
● 47450000	1/2"	NR	1	20	10	151,82

CARTUCCIA DEVIATRICE



Compatibilità:

- 1431016 Termostatico tondo

codice	∅	UM	min. ord.	conf.	cat.	prezzo (€)
● 3101122	mm 34	NR	1	1	09	27,50

RICAMBI RUBINETTERIA

RICAMBI

DADO MANIGLIA

Compatibilità:

3001010 Lavabo
 3001027 Lavabo "Big Size"
 3001011 Lavabo alto
 3001012 Bidet
 3001018 Doccia esterno
 3001017 Vasca con kit doccia



codice	descrizione	UM	min. ord.	conf.	cat.	prezzo (€)
3101102	ricambio	NR	1	1	06	27,14

DADO MANIGLIA

Compatibilità:

3001013 Lavabo parete
 3001014 Doccia incasso
 3001019 Doccia incasso
 3001015 Doccia incasso con deviatore
 3001020 Doccia incasso con deviatore
 3001016 Doccia incasso 3 vie



codice	descrizione	UM	min. ord.	conf.	cat.	prezzo (€)
3101103	ricambio	NR	1	1	06	30,24

TONDA MANIGLIA

Compatibilità:

3021010 Lavabo
 3021026 Lavabo
 3021011 Lavabo alto
 3021012 Bidet
 3021027 Bidet
 3021014 Lavabo parete piastra unica
 3021017 Doccia incasso c/deviatore 2 vie
 3021031 Vasca a pavimento



codice	descrizione	UM	min. ord.	conf.	cat.	prezzo (€)
3101106	ricambio	NR	1	1	06	42,73

TONDA MANIGLIA

Compatibilità:

3021020 Doccia esterno



codice	descrizione	UM	min. ord.	conf.	cat.	prezzo (€)
3101104	ricambio	NR	1	1	06	30,42

TONDA MANIGLIA

Compatibilità:

3021013 lavabo a parete
 3021015 doccia incasso
 3021016 doccia incasso con deviatore
 3021017 doccia incasso con deviatore 2 vie
 3021018 doccia incasso con deviatore 3 vie
 3021021 doccia incasso con deviatore solo parti esterne
 3021022 doccia incasso solo parti esterne

NOVITÀ!



codice	descrizione	UM	min. ord.	conf.	cat.	prezzo (€)
3101157	ricambio	NR	1	1	06	41,33

NEMO MANIGLIA

Compatibilità:

Per tutta la serie NEMO escluso:

3003019 Lavabo leva clinica



codice	descrizione	UM	min. ord.	conf.	cat.	prezzo (€)
3101075	ricambio	NR	1	1	02	30,59

MAYA MANIGLIA

Compatibilità:

3008001 Lavabo
 3008010 Lavabo "Big Size"
 3008002 Lavabo corpo alto
 3008003 Bidet



codice	descrizione	UM	min. ord.	conf.	cat.	prezzo (€)
3008903	ricambio	NR	1	1	02	76,02

MAYA MANIGLIA STANDARD

Compatibilità:

3008011 Lavabo
 3008009 Lavabo "Big Size"
 3008012 Bidet
 3008006 Doccia incasso con deviatore
 3008004 Doccia incasso
 3008005 Doccia esterno
 3008007 Vasca con kit doccia
 3008032 Lavello collo cigno



3008033 Lavello bocca girevole
 3008034 Lavello con doccetta

codice	descrizione	UM	min. ord.	conf.	cat.	prezzo (€)
3008913	ricambio	NR	1	1	02	76,02

DELFINO UNO MANIGLIA



codice	descrizione	UM	min. ord.	conf.	cat.	prezzo (€)
3101001	ricambio	NR	1	10	02	27,34

DELFINO DUE MANIGLIA

Compatibilità:

Per tutta la serie DELFINO DUE escluso:

3004009 Lavabo leva clinica
 3006001 Lavabo bocca estraibile



codice	descrizione	UM	min. ord.	conf.	cat.	prezzo (€)
3101064	ricambio	NR	1	10	02	14,59

RICAMBI

EVA MANIGLIA



Compatibilità:

Per tutta la serie EVA

codice	descrizione	UM	min. ord.	conf.	cat.	prezzo (€)
● 3101057	ricambio	NR	2	2	02	27,34

TRADIZIONALE MANIGLIA



Compatibilità:

Per tutta la serie TRADIZIONALE

codice	descrizione	UM	min. ord.	conf.	cat.	prezzo (€)
● 3101054	ricambio	NR	2	2	02	13,05

MANIGLIA LAVELLO SOTTOFINESTRA



Compatibilità:

1434001 Lavello sottofinestra

codice	descrizione	UM	min. ord.	conf.	cat.	prezzo (€)
● 3101116	ricambio	NR	1	1	02	37,54

MANIGLIA



Compatibilità:

3006001 Lavabo bocca estraibile
1434007 Lavello bocca estraibile

codice	descrizione	UM	min. ord.	conf.	cat.	prezzo (€)
● 3101114	ricambio	NR	1	1	02	32,47

GIULIO MANIGLIA



Compatibilità:

3001000 Lavabo 3 acque

codice	descrizione	UM	min. ord.	conf.	cat.	prezzo (€)
● 3101115	ricambio	NR	1	1	02	32,47

ELIO MANIGLIA



Compatibilità:

3008850 Lavello piega tonda

codice	descrizione	UM	min. ord.	conf.	cat.	prezzo (€)
● 3008922	ricambio	NR	1	1	02	57,43

ZERO/MAYA LEVA CLINICA



Compatibilità:

3008802 Lavabo leva clinica

codice	descrizione	UM	min. ord.	conf.	cat.	prezzo (€)
● 3008901	ricambio	NR	1	1	02	65,89

NEMO LEVA CLINICA



Compatibilità:

3003019 Lavabo leva clinica

codice	descrizione	UM	min. ord.	conf.	cat.	prezzo (€)
● 3101070	per cartuccia 35 mm	NR	1	1	02	16,01

DELFINO UNO / DELFINO DUE LEVA CLINICA



Compatibilità:

3002014 Lavello leva clinica
3002013 Lavello parete leva clinica
3004009 Lavabo leva clinica
3006001 Lavabo bocca estraibile

codice	descrizione	UM	min. ord.	conf.	cat.	prezzo (€)
● 3101004	per cartuccia 40 mm	NR	1	1	02	17,44

RICAMBI RUBINETTERIA

RICAMBI

MAYA/ZERO PROLUNGA

**Compatibilità:**

per incassi doccia con deviatore
3008006 Doccia incasso con deviatore
3008805 Doccia incasso con deviatore

codice	lunghezza	UM	min. ord.	conf.	cat.	prezzo (€)
● 3008918	cm.3,5	NR	1	1	02	96,29

MAYA/ZERO PROLUNGA

**Compatibilità:**

per incassi doccia senza deviatore
3008004 Doccia incasso
3008804 Doccia incasso

codice	lunghezza	UM	min. ord.	conf.	cat.	prezzo (€)
● 3008919	cm.3,5	NR	1	1	02	72,62

DELFINO DUE PROLUNGA

**Compatibilità:**

per incassi doccia senza deviatore
3004003 Doccia incasso

codice	lunghezza	UM	min. ord.	conf.	cat.	prezzo (€)
● 3101020	cm. 3	NR	1	1	02	80,93

DADO/TONDA PROLUNGA DOCCIA INCASSO 1 VIA A PULSANTE

**Compatibilità:**

per incassi doccia senza deviatore
3001014 Doccia incasso
3021015 Doccia incasso

codice	lunghezza	UM	min. ord.	conf.	cat.	prezzo (€)
● 3101123	cm. 3,75	NR	1	1	02	68,44

DADO/TONDA PROLUNGA DOCCIA INCASSO 2 VIE A PULSANTE

**Compatibilità:**

per incassi doccia con deviatore a pulsante
3001015 Doccia incasso con deviatore
3021016 Doccia incasso con deviatore

codice	lunghezza	UM	min. ord.	conf.	cat.	prezzo (€)
● 3101124	cm. 3,75	NR	1	1	02	150,59

MAYA/ZERO DEVIATORE DOCCIA INCASSO

**Compatibilità:**

3008006 Doccia incasso con deviatore.
3008805 Doccia incasso con deviatore.

codice	descrizione	UM	min. ord.	conf.	cat.	prezzo (€)
● 3008910	ricambio	NR	1	1	02	65,89

NEMO PLACCA PER DOCCIA INCASSO SENZA DEVIATORE

**Compatibilità:**

3003014 Doccia

codice	descrizione	UM	min. ord.	conf.	cat.	prezzo (€)
● 3101081	ricambio	NR	1	1	02	19,78

DELFINO DUE PLACCA DOCCIA INCASSO SENZA DEVIATORE

**Compatibilità:**

3004003 Doccia

codice	descrizione	UM	min. ord.	conf.	cat.	prezzo (€)
● 3101065	ricambio	NR	1	1	02	19,78

MAYA DOCCETTA PER LAVELLO CUCINA



Compatibilità:
3008034 Lavello con doccetta

codice	lunghezza	UM	min. ord.	conf.	cat.	prezzo (€)
● 3008911	cm. 10	NR	1	1	02	88,03

DELFINO DUE BOCCA ESTRAIBILE PER LAVABO

In ABS



Compatibilità:
3006001 Lavabo bocca estraibile

codice	descrizione	UM	min. ord.	conf.	cat.	prezzo (€)
● 3101096	ricambio	NR	1	1	02	30,91

DOCCETTA A CAMPANA

In ottone
PORTATA litri/minuto: 25



Compatibilità:
3007009 Vasca

codice	sez. (mm)	lung. (mm)	UM	min. ord.	conf.	cat.	prezzo (€)
● 1412003	Ø 52	184	NR	1	100	06	25,52

DOCCETTA PER LAVELLO CUCINA



Compatibilità:
1434007 Lavello con doccetta

codice	lunghezza	UM	min. ord.	conf.	cat.	prezzo (€)
● 1413028	cm. 17	NR	1	1	02	16,49

CONFEZIONE FISSAGGI LAVELLO CUCINA



codice	descrizione	UM	min. ord.	conf.	cat.	prezzo (€)
● 3101015	n. 1 vite M8	NR	1	20	02	8,00

CONFEZIONE FISSAGGI LAVABO/BIDET



codice	descrizione	UM	min. ord.	conf.	cat.	prezzo (€)
● 3101014	n. 2 viti M6	NR	1	20	02	8,00

FLESSIBILE PER DOCCETTA ESTRAIBILE

F 1/2" x M15



Compatibilità:
3006001 Lavabo bocca estraibile
1434007 Lavello doccetta estraibile

codice	lunghezza	UM	min. ord.	conf.	cat.	prezzo (€)
● 3101111	cm. 125	NR	1	1	02	23,46

FLESSIBILE PVC PER DOCCETTA ESTRAIBILE

F 1/2" x M15



codice	lunghezza	UM	min. ord.	conf.	cat.	prezzo (€)
● 3101018	cm. 120	NR	1	10	02	30,26

GROHE FLESSIBILE PER MISCELATORI LAVELLO

F 1/2" x M15



codice	lunghezza	UM	min. ord.	conf.	cat.	prezzo (€)
● 46092000	ricambio	NR	1	1	10	110,54

GROHE FLESSIBILE DI RACCORDO 420mm 3/8"



codice	UM	min. ord.	conf.	cat.	prezzo (€)
● 48066000	NR	1	1	10	21,95

RICAMBI RUBINETTERIA

RICAMBI

FLESSIBILE PER LAVELLO CUCINA

F 1/2" x M15



codice	lunghezza	UM	min. ord.	conf.	cat.	prezzo (€)
● 1413029	cm. 150	NR	1	50	09	19,88
● 1413069	cm. 200	NR	1	50	09	19,80

DELFINO DUE BOCCA EROGAZIONE



Compatibilità:
3004008 Lavello parete

codice	lunghezza (mm)	UM	min. ord.	conf.	cat.	prezzo (€)
● 3101038	200	NR	1	10	02	41,40
● 3101066	300	NR	1	10	02	50,86

TONDA BOCCA EROGAZIONE



Compatibilità:
3021025 Lavello collo cigno

codice	descrizione	UM	min. ord.	conf.	cat.	prezzo (€)
● 3101138	ricambio	NR	1	1	02	64,02

DELFINO DUE BOCCA EROGAZIONE



Compatibilità:
3004010 Lavello dal 2018

codice	descrizione	UM	min. ord.	conf.	cat.	prezzo (€)
● 3101090	ricambio	NR	1	5	02	61,15

EVA BOCCA EROGAZIONE



Compatibilità:
3007018 Lavello

codice	descrizione	UM	min. ord.	conf.	cat.	prezzo (€)
● 3101084	ricambio	NR	1	8	02	35,12

AMEDEO BOCCA EROGAZIONE



Compatibilità:
3005050 Lavello

codice	descrizione	UM	min. ord.	conf.	cat.	prezzo (€)
● 3101110	nera / cromo	NR	1	1	02	101,05

AMEDEO BOCCA EROGAZIONE



Compatibilità:
3005051 Lavello

codice	descrizione	UM	min. ord.	conf.	cat.	prezzo (€)
● 3101109	bianca / cromo	NR	1	1	02	101,05

CARTUCCIA PER KIT DELO' PUR

Capacità 15.000 litri/anno.

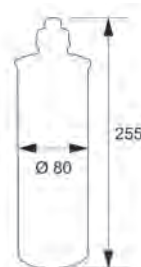

codice	descrizione	UM	min. ord.	conf.	cat.	prezzo (€)
● 2006098	cartuccia di ricambio	NR	1	6	03	99,00

GROHE BLUE FILTRO BWT



codice	capacità media	altezza (H)	UM	min. ord.	conf.	cat.	prezzo (€)
● 40404001	600 litri	234	NR	1	1	13	133,38
● 40430001	1.500 litri	315	NR	1	1	13	263,95

RICAMBI RUBINETTERIA

BOCCE DI EROGAZIONE UNIVERSALI

BOCCA "U" CON AERATORE

Canna D. 18 mm,
attacco 3/4"



codice	sigla	lunghezza (mm)	UM	min. ord.	conf.	cat.	prezzo (€)
● 2670001	3024.201.3.	200	NR	1	10	06	20,48
● 2670002	3024.251.3.	250	NR	1	10	06	21,64
● 2670003	3024.301.3.	300	NR	1	5	06	22,46

BOCCA "J" CON AERATORE

Canna D. 18 mm,
attacco 3/4"



codice	sigla	lung. (mm)	H (cm)	UM	min. ord.	conf.	cat.	prezzo (€)
● 2670011	3026.201.3.	200	15	NR	1	10	06	21,64
● 2670012	3026.251.3.	250	20	NR	1	10	06	24,19

BOCCA "S" CON AERATORE

Canna D. 18 mm,
attacco 3/4"



codice	sigla	lunghezza (mm)	UM	min. ord.	conf.	cat.	prezzo (€)
● 2670020	3022.151.3.	150	NR	1	10	06	19,66
● 2670021	3022.201.3.	200	NR	1	10	06	20,48
● 2670022	3022.251.3.	250	NR	1	10	06	21,64
● 2670023	3022.301.3.	300	NR	1	5	06	22,46

BOCCA "CIGNO" CON AERATORE

Canna D. 18 mm,
attacco 3/4"



codice	lunghezza (mm)	H (cm)	UM	min. ord.	conf.	cat.	prezzo (€)
● 2670031	200	14	NR	1	10	06	17,17

PILETTE

PILETTA AUTOMATICA UNIVERSALE INOX 316

Ideale per lavabi di diversi spessori, tappo coprente in acciaio inox, meccanismo clicker, vite centrale passante da 80 mm.



NOVITÀ!

codice	∅	tappo (mm)	UM	min. ord.	conf.	cat.	prezzo (€)
● 2106500	1"1/4	63,5	NR	1	1	01	60,06



PILETTA TAPPO SALTERELLO, SENZA COMANDO

Piletta in ottone, tappo in ottone.



RICAMBI (PAG. 199)
2661095 - Tappo

codice	∅	tappo (mm)	UM	min. ord.	conf.	cat.	prezzo (€)
● 2106003	1"1/4x63	40	NR	1	30	01	26,86
● 2106002	1" x63 (fuori norma)	40	NR	1	30	01	26,86

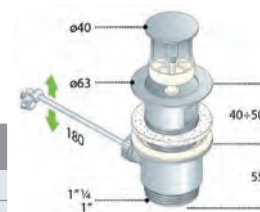

AERATORI

AERATORE HONEYCOMB MASCHIO

Filtro in plastica



codice	sigla	∅	portata (lt/min)	UM	min. ord. conf.	cat.	prezzo (€)
● 2751001	01403195	M 24x1	7,5 - 9	NR	10	09	2,60

AERATORE HONEYCOMB FEMMINA

Filtro in plastica



codice	sigla	∅	portata (lt/min)	UM	min. ord. conf.	cat.	prezzo (€)
● 2751002	01403095	M 22x1	7,5 - 9	NR	10	09	2,60

AERATORE HONEYCOMB MASCHIO

Filtro in plastica



codice	sigla	∅	portata (lt/min)	UM	min. ord. conf.	cat.	prezzo (€)
● 2751017	01401795	M 28x1	27 - 30	NR	5	09	6,32

AERATORE CASCADE MASCHIO

Protezione anticalcare superiore, rumorosità estremamente ridotta, antischiumamento



codice	sigla	∅	portata (lt/min)	UM	min. ord. conf.	cat.	prezzo (€)
● 2751020	01030094	M 24x1	13,5 - 15	NR	10	09	3,68

AERATORE CASCADE FEMMINA

Protezione anticalcare superiore, rumorosità estremamente ridotta, antischiumamento



codice	sigla	∅	portata (lt/min)	UM	min. ord. conf.	cat.	prezzo (€)
● 2751021	01010094	M 22x1	13,5 - 15	NR	10	09	3,68

AERATORE CASCADE MASCHIO

Protezione anticalcare superiore, rumorosità estremamente ridotta, antischiumamento



codice	sigla	∅	portata (lt/min)	UM	min. ord. conf.	cat.	prezzo (€)
● 2751022	01040094	M 28x1	27 - 30	NR	5	09	6,68

AERATORE DE LUX MASCHIO

Filtro in plastica. Getto morbido e ventilato.



codice	sigla	∅	portata (lt/min)	UM	min. ord. conf.	cat.	prezzo (€)
● 2751030	40460495	M 24x1	13,5 - 15	NR	10	09	1,80

AERATORE DE LUX FEMMINA

Filtro in plastica. Getto morbido e ventilato.



codice	sigla	∅	portata (lt/min)	UM	min. ord. conf.	cat.	prezzo (€)
● 2751031	40460395	M 22x1	13,5 - 15	NR	10	09	1,80

AERATORE DE LUX MASCHIO

Filtro in plastica. Getto morbido e ventilato.



codice	sigla	∅	portata (lt/min)	UM	min. ord. conf.	cat.	prezzo (€)
● 2751032	40460695	M 28x1	27 - 30	NR	5	09	4,00

CACHE' HONEYCOMB MASCHIO



codice	sigla	∅	portata (lt/min)	UM	min. ord. conf.	cat.	prezzo (€)
● 2751200	01515190	M 16,5x1	totale	NR	20	09	6,40

RICAMBI RUBINETTERIA

AERATORI

CACHE' HONEYCOMB MASCHIO

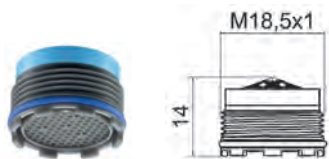

codice	sigla	Ø	portata (lt/min)	UM	min. ord. conf.	cat.	prezzo (€)
● 2751201	01515590	M 18,5x1	13,5-15	NR	20	09	6,40

CACHE' HONEYCOMB MASCHIO



codice	sigla	Ø	portata (lt/min)	UM	min. ord. conf.	cat.	prezzo (€)
● 2751202	01510190	M 21,5x1	13,5-15	NR	1	09	6,40

MAYA/ZERO CACHE' COIN SLOT



Compatibilità:
3008003 Bidet
3008012 Bidet
3008803 Bidet

codice	Ø	UM	min. ord. conf.	cat.	prezzo (€)
● 2751204	M 16,5x1	NR	10	09	9,72

GIULIO CACHE'

Senza parte cromata



Compatibilità:
3001000 Lavello 3 acque

codice	descrizione	UM	min. ord. conf.	cat.	prezzo (€)
● 3101120	ricambio	NR	1	09	17,04

CACHE' SLIM MASCHIO

Orientabile



codice	Ø	Portata (lt/min)	UM	min. ord. conf.	cat.	prezzo (€)
● 2751061	M 24x1	13,5-15	NR	1	09	6,44

CACHE COIN SLOT MASCHIO

Fessura che permette di avvitare e svitare con una moneta. Utilizzabile senza guscio in ottone. Compatibile con aeratori M24x1 esistenti

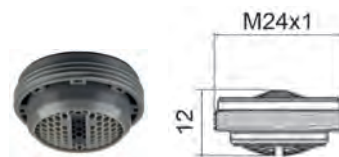

codice	sigla	Ø	Portata (lt/min)	UM	min. ord. conf.	cat.	prezzo (€)
● 2751060	45302894	M 24x1	13,5-15	NR	10	09	8,80

AERATORE A SNODO MASCHIO

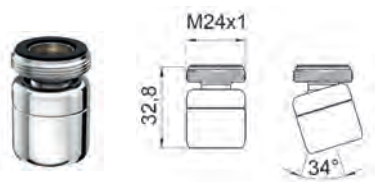

codice	sigla	Ø	UM	min. ord. conf.	cat.	prezzo (€)
● 2750450	01040001CR	M 24x1	NR	10	09	8,08

AERATORE A SNODO FEMMINA



codice	sigla	Ø	UM	min. ord. conf.	cat.	prezzo (€)
● 2750451	01030001CR	M 22x1	NR	10	09	8,08

AERATORE A SNODO PER INCASSO MASCHIO



codice	sigla	Ø	UM	min. ord. conf.	cat.	prezzo (€)
● 2750452	01050001CR	M 24x1	NR	10	09	9,04

RIDUZIONE PER AERATORI



codice	sigla	Ø	UM	min. ord. conf.	cat.	prezzo (€)
● 2750400	06820000CR	M 22x1 - M 24x1	NR	10	09	2,48

AERATORI

RIDUZIONE PER AERATORI



codice	sigla	Ø	UM	min. conf.	ord. cat.	prezzo (€)
● 2750410	06810400CR	M 1/2" - F 22x1	NR	10	09	3,20
● 2750411	06810500CR	M 3/4" - F 22x1	NR	10	09	3,48

RIDUZIONE PER AERATORI



codice	sigla	Ø	UM	min. conf.	ord. cat.	prezzo (€)
● 2750401	0681M400CR	M 1/2" - M 24x1	NR	10	09	4,68

CHIAVE UNIVERSALE NICHELATA



codice	sigla	Ø	UM	min. conf.	ord. cat.	prezzo (€)
● 2751305	01458097	M22-M24-M28-M18 cachè 16,5-18,5-21,5	NR	1	09	19,52

CHIAVE UNIVERSALE PLASTICA



codice	sigla	Ø	UM	min. conf.	ord. cat.	prezzo (€)
● 2751307	01455094	M22-M24-M28 cachè 16,5-18,5-21,5	NR	1	09	15,40

CHIAVE DI MONTAGGIO CACHE'



codice	sigla	Ø	colore	UM	min. conf.	ord. cat.	prezzo (€)
● 2751302	09915046	M 16,5x1	GIALLA	NR	1	09	1,40
● 2751303	09915346	M 18,5x1	VERDE	NR	1	09	1,40
● 2751308	09915146	M 21,5x1	ROSSA	NR	1	09	1,40
● 2751304	09915246	M 24x1	GRIGIO	NR	1	09	1,40

KIT WATERSAVING

Composto da:
 n. 1 chiave in plastica blu per aeratori M22 - M24 - M28,
 n. 3 aeratori maschio M24x1
 n. 1 aeratore femmina M22x1
 Risparmio idrico 50%



codice	sigla	descrizione	UM	min. ord.	conf. cat.	prezzo (€)
● 2751090	35626200001	kit casa	NR	1	15 09	13,40

CATALOGO
LISTINO N° 8

LINEA DOCCIA

INOX 316	78
TERMOSTATICI E MISCELATORI	83
COLONNE DOCCIA	88
SALISCENDI	100
SOFFIONI DOCCIA	104
BRACCI DOCCIA	109
DOCCETTE	112
SET DOCCIA	115
PRESE ACQUA	116
SUPPORTI DOCCIA	118
IDROSCOPINI E KIT DOCCETTA	119
FLESSIBILI DOCCIA	122
RICAMBI	123

LINEA DOCCIA

INOX 316

MAGNOLIA COLONNA DOCCIA CON SOFFIONE SQUARE

Colonna doccia telescopica in acciaio inox 316, con doccetta monogetto rettangolare in acciaio inox 316 (1412502), flessibile pvc argento da 150cm., completa di soffione square da 250 mm. in acciaio inox 316 (1403089), miscelatore in acciaio inox 316 con deviatore incorporato.

LINEA
DOCCIA

NOVITÀ!

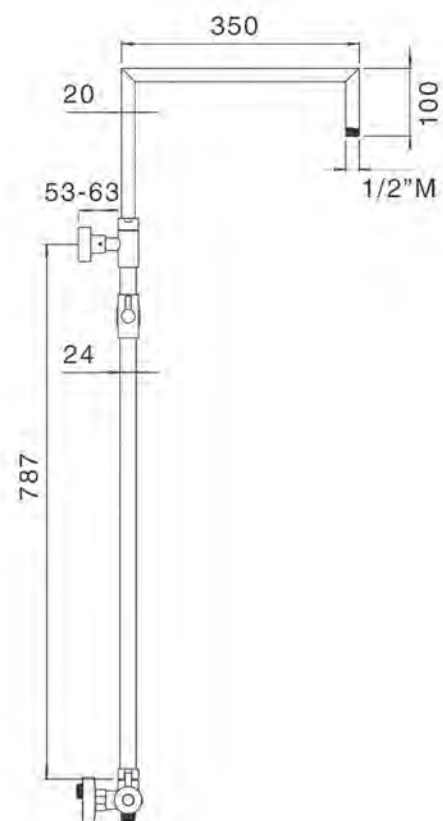
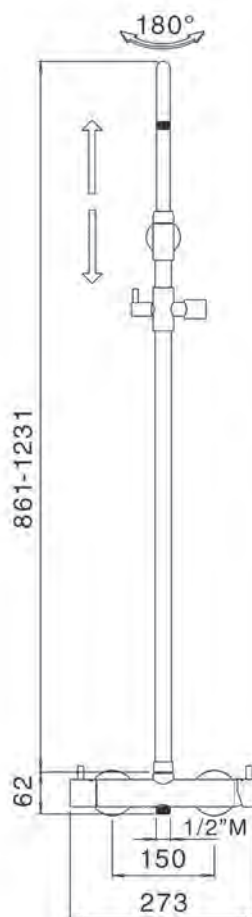

codice	UM	min. ord.	conf.	cat.	prezzo (€)
1350704	NR	1	1	04	823,48

MAGNOLIA COLONNA DOCCIA CON SOFFIONE ROUND

Colonna doccia telescopica in acciaio inox 316, con doccetta monogetto tonda in acciaio inox 316 (1412501), flessibile pvc argento da 150 cm., completa di soffione round D.250 mm. in acciaio inox 316 (1403088), miscelatore in acciaio inox 316 con deviatore incorporato.

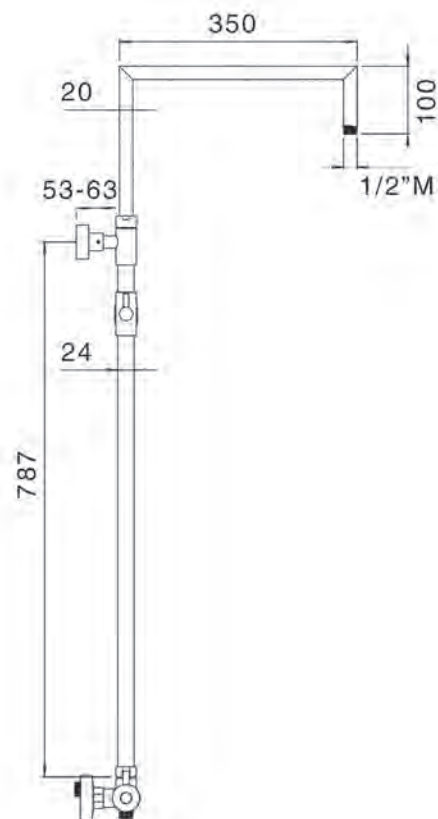
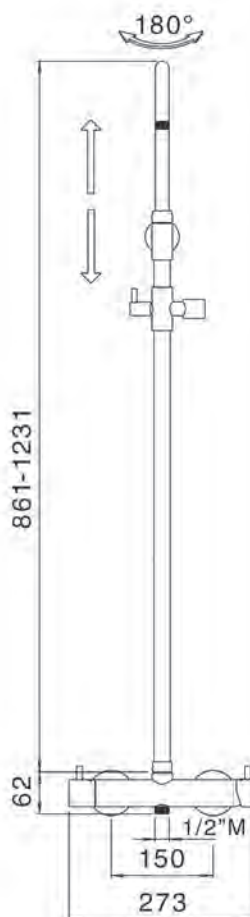

codice	UM	min. ord.	conf.	cat.	prezzo (€)
1350703	NR	1	1	04	823,48

LINEA DOCCIA

INOX 316

SALISCENDI MILA

Set composto da: asta doccia in acciaio inox 316 D.20mm. da 90 cm. con supporto regolabile, doccetta monogetto tonda D.24 mm. in acciaio inox 316 (1412501), flessibile pvc argento da 150 cm., kit di fissaggio.

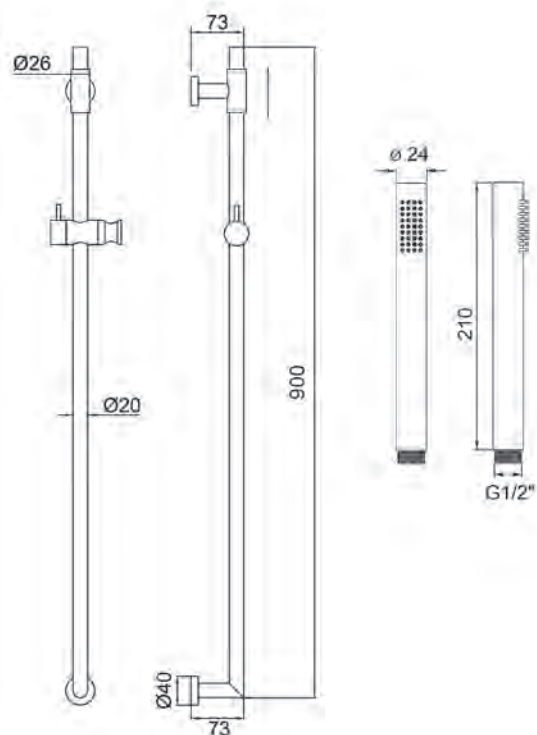

codice	UM	min. ord.	conf.	cat.	prezzo (€)
1324001	NR	1	1	01	240,54

SALISCENDI LAVINA

Set composto da: asta doccia in acciaio inox 316 da 30x10 mm. da 70 cm., doccetta monogetto rettangolare in acciaio inox 316 (1412502), flessibile pvc argento da 150 cm., kit di fissaggio.

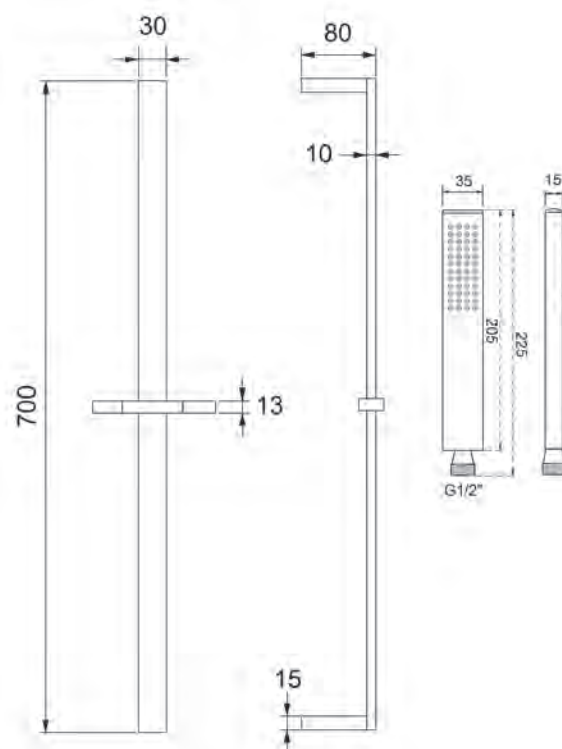

codice	UM	min. ord.	conf.	cat.	prezzo (€)
1325001	NR	1	1	01	249,08

SQUARE SOFFIONE

In acciaio inox 316 anticalcare ed ispezionabile.
Portata litri/min.: **18,4**



codice	dimensioni (mm)	UM	min. ord.	conf.	cat.	prezzo (€)
1403089	250	NR	1	1	06	273,46

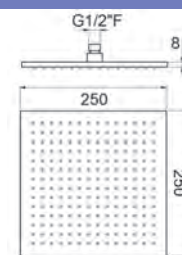

ROUND SOFFIONE

In acciaio inox 316 anticalcare ed ispezionabile.
Portata litri/min.: **18,5**



codice	dimensioni (mm)	UM	min. ord.	conf.	cat.	prezzo (€)
1403088	250	NR	1	1	06	254,88

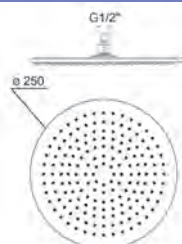

MADRID BRACCIO DOCCIA

In acciaio inox 316
L.22 x22 mm



codice	dimensioni (mm)	UM	min. ord.	conf.	cat.	prezzo (€)
1405040	40	NR	1	1	02	145,66

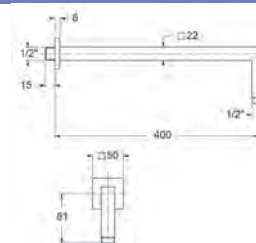

LECCE BRACCIO DOCCIA

In acciaio inox 316
L.22 x22 mm



codice	dimensioni (mm)	UM	min. ord.	conf.	cat.	prezzo (€)
1405041	40	NR	1	1	02	96,70

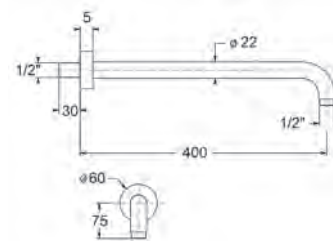

DOCCETTA RETTANGOLARE

Monogetto in acciaio inox 316, anticalcare
Portata litri/min.: **12,4**



codice	sez. (mm)	lung. (mm)	UM	min. ord.	conf.	cat.	prezzo (€)
1412502	35x15	205	NR	1	1	06	50,33

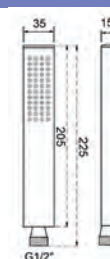

DOCCETTA TONDA

Monogetto in acciaio inox 316, anticalcare
Portata litri/min.: **12,4**



codice	sez. (mm)	lung. (mm)	UM	min. ord.	conf.	cat.	prezzo (€)
1412501	Ø 24	210	NR	1	1	06	45,36



LINEA DOCCIA

INOX 316

LINEA
DOCCIA

SET DOCCIA QUADRA CON PRESA ACQUA

Set composto da: doccetta rettangolare inox 316 (1412502), presa acqua centrale quadrata inox 316 (1409507), flessibile pvc argento da 150 cm.

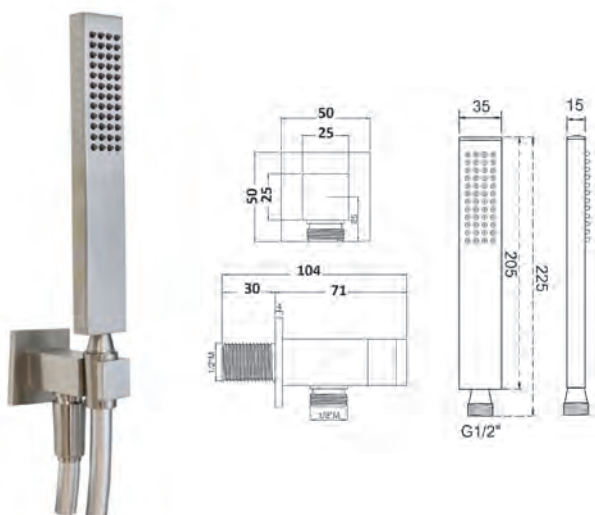

codice	UM	min. ord.	conf.	cat.	prezzo (€)
1409510	NR	1	1	02	138,62

SET DOCCIA TONDA CON PRESA ACQUA

Set composto da: doccetta tonda inox 316 (1412501), presa acqua centrale tonda inox 316 (1409027), flessibile pvc argento da 150 cm.

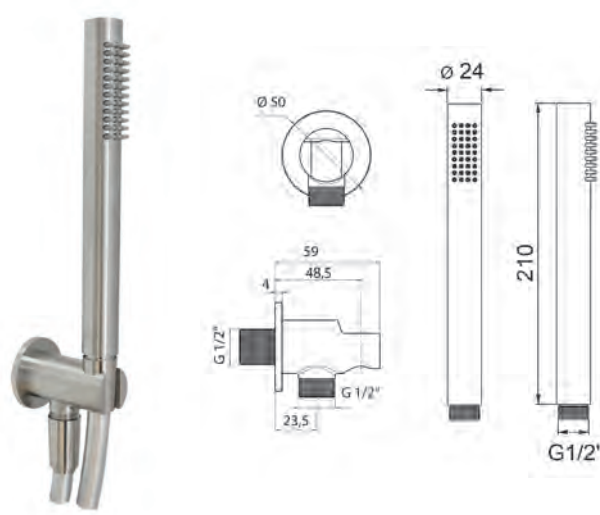

codice	UM	min. ord.	conf.	cat.	prezzo (€)
1409512	NR	1	1	02	127,57

PRESA ACQUA QUADRATA CENTRALE

In acciaio inox 316

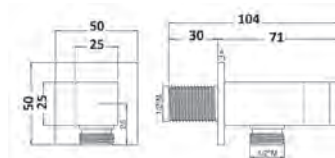

codice	attacchi	UM	min. ord.	conf.	cat.	prezzo (€)
1409507	1/2" M x 1/2" M	NR	1	1	02	57,12

PRESA ACQUA TONDA CENTRALE

In acciaio inox 316

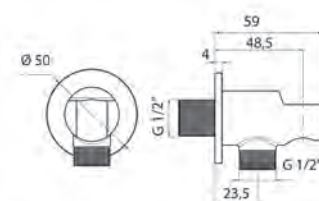

codice	attacchi	UM	min. ord.	conf.	cat.	prezzo (€)
1409027	1/2" M x 1/2" M	NR	1	1	02	57,12

TERMOSTATICO INCASSO TONDO 2 VIE



RICAMBI (PAG. 60-75)
3101230 - Cartuccia termostatica D. 34

codice	finitura	UM	min. ord.	conf.	cat.	prezzo (€)
● 3012002	cromo	NR	1	10	11	279,65
3012902	nero opaco	NR	1	10	11	421,08

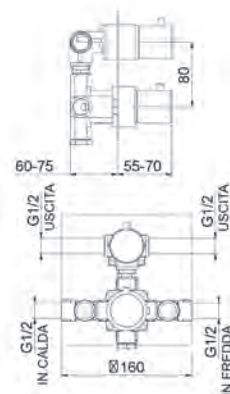

TERMOSTATICO INCASSO TONDO 3 VIE



RICAMBI (PAG. 60-75)
3101230 - Cartuccia termostatica D. 34

codice	finitura	UM	min. ord.	conf.	cat.	prezzo (€)
● 3012003	cromo	NR	1	10	11	365,34
3012903	nero opaco	NR	1	10	11	512,31

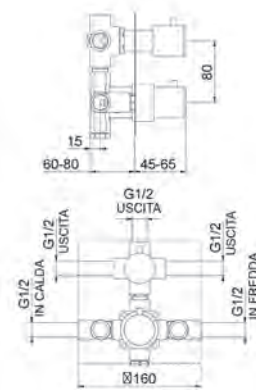

TERMOSTATICO INCASSO QUADRO 2 VIE



RICAMBI (PAG. 60-75)
3101230 - Cartuccia termostatica D. 34

codice	finitura	UM	min. ord.	conf.	cat.	prezzo (€)
● 3013002	cromo	NR	1	10	11	439,93
3013902	nero opaco	NR	1	10	11	638,64

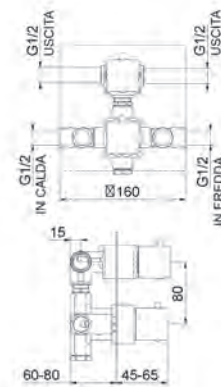

TERMOSTATICO INCASSO QUADRO 3 VIE



RICAMBI (PAG. 60-75)
3101230 - Cartuccia termostatica D. 34

codice	finitura	UM	min. ord.	conf.	cat.	prezzo (€)
● 3013003	cromo	NR	1	10	11	439,93
3013903	nero opaco	NR	1	10	11	638,64

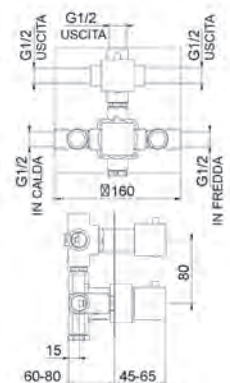

LINEA DOCCIA

GROHE SMARTCONTROL

MISCELATORE TERMOSTATICO A 2 VIE QUADRATO



Solo parti esterne cromate, da completare con il corpo incasso universale Rapido Smartbox (35604000)

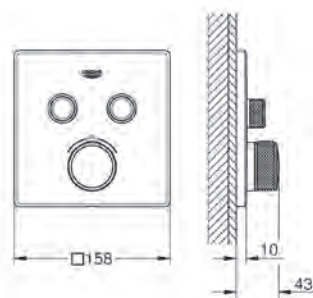

codice	UM	min. ord.	conf.	cat.	prezzo (€)
● 29124000	NR	1	6	10	877,83

MISCELATORE TERMOSTATICO A 2 VIE TONDO



Solo parti esterne cromate, da completare con il corpo incasso universale Rapido Smartbox (35604000)

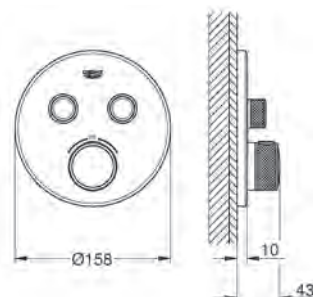

codice	UM	min. ord.	conf.	cat.	prezzo (€)
● 29119000	NR	1	12	10	877,83

RAPIDO SMARTBOX CORPO INCASSO UNIVERSALE



Per miscelatori Smartcontrol e per tutte le serie ad incasso Grohe.

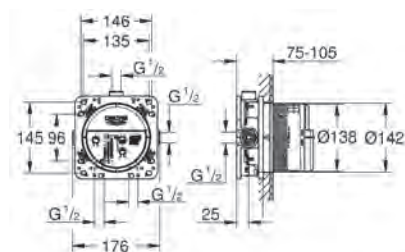

codice	UM	min. ord.	conf.	cat.	prezzo (€)
● 35604000	NR	1	12	13	107,95

TERMOSTATICO BLISS TONDO "COOL BODY"

Il termostatico "COOL BODY" è in grado di isolare la propria superficie esterna lasciandola fredda, permettendo una maggiore sicurezza contro le scottature.



RICAMBI (PAG. 60-75)

3101077 - Cartuccia termostatica D. 34 (solo cromo)



codice	finitura	UM	min. ord.	conf.	cat.	prezzo (€)
● 1431018	cromo	NR	1	1	03	197,61
● 1431918	nero opaco	NR	1	1	03	266,78
● 1431818	simil acciaio	NR	1	1	03	276,66

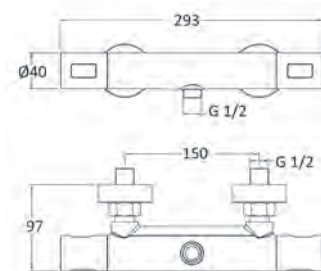

TERMOSTATICO DOCCIA ESTERNO

Attacco da 1/2", maniglie in ABS.



RICAMBI (PAG. 60-75)

3101061 - Cartuccia termostatica D. 40

3101032 - Vitone

codice	UM	min. ord.	conf.	cat.	prezzo (€)
● 3001005	NR	1	8	03	146,03

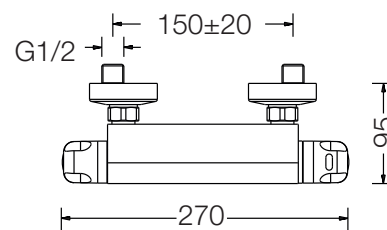

LINEA DOCCIA

TERMOSTATICI PER COLONNA DOCCIA

TERMOSTATICO PER COLONNA DOCCIA 2 USCITE

Attacchi da 1/2" con deviatore incorporato per colonne VIOLA, MAGNOLIA e NARCISO. Maniglie in ABS.



RICAMBI (PAG. 60-75)

- 3101088 - Cartuccia termostatica D 40
- 3101089 - Cartuccia deviatrice

codice	UM	min. ord.	conf.	cat.	prezzo (€)
● 1431021	NR	1	9	03	206,78

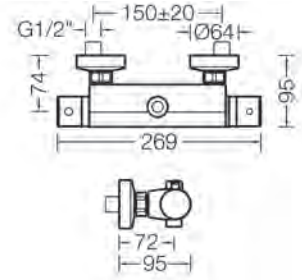

TERMOSTATICO BLISS TONDO PER COLONNA DOCCIA 2 USCITE, "COOL BODY"

Il termostatico "COOL BODY" ha il corpo freddo in grado di isolare la superficie esterna del termostatico lasciandola fredda, permettendo una maggiore sicurezza contro le scottature. Attacchi da 1/2" con deviatore incorporato per colonne VIOLA, MAGNOLIA e NARCISO. Maniglie metalliche.



RICAMBI (PAG. 60-75)

- 3101077 - Cartuccia termostatica D. 34(solo cromo)
- 3101122 - Cartuccia deviatrice

codice	finitura	UM	min. ord.	conf.	cat.	prezzo (€)
● 1431016	cromo	NR	1	9	03	229,36
● 1431916	nero opaco	NR	1	9	03	309,61
● 1431816	simil acciaio	NR	1	9	03	321,08

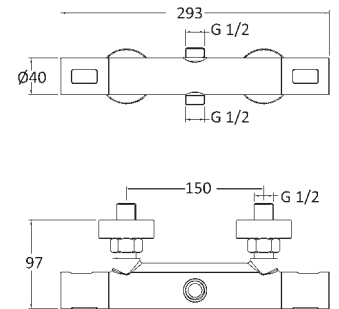

TERMOSTATICO QUADRATO PER COLONNA DOCCIA 2 USCITE

Attacchi da 1/2" con deviatore incorporato per colonne VIOLA, MAGNOLIA e NARCISO. Maniglie in ABS.



RICAMBI (PAG. 60-75)

- 3101117 - Cartuccia termostatica D. 40
- 3101032 - Vitone

codice	UM	min. ord.	conf.	cat.	prezzo (€)
● 1431024	NR	1	10	03	263,22

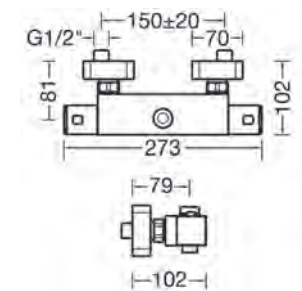

DOCCIA ESTERNO PER COLONNA DOCCIA 2 USCITE, "COOL BODY"

Il miscelatore "COOL BODY" è in grado di isolare la propria superficie esterna lasciandola fredda, permettendo una maggiore sicurezza contro le scottature.

Attacchi da 1/2" con deviatore incorporato per colonne VIOLA, MAGNOLIA e NARCISO. Maniglie metalliche.



RICAMBI (PAG. 60-75)
3101074 - Cartuccia D. 35



codice	finitura	UM	min. ord.	conf.	cat.	prezzo (€)
● 1431015	cromo	NR	1	9	03	175,20
● 1431915	nero opaco	NR	1	9	03	236,48
1431815	simil acciaio	NR	1	9	03	245,29

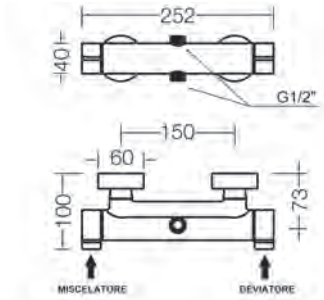

DOCCIA ESTERNO PER COLONNA DOCCIA 1 USCITA

Reversibile: l'attacco da 1/2" può essere posizionato sia nella parte superiore sia nella parte inferiore, girando il miscelatore. Maniglia metallica.



RICAMBI (PAG. 60-75)
3101042 - Cartuccia D. 35



codice	finitura	UM	min. ord.	conf.	cat.	prezzo (€)
● 1430007	cromo	NR	1	10	03	159,46
1430907	nero opaco	NR	1	10	03	215,49
1430807	simil acciaio	NR	1	10	03	223,41

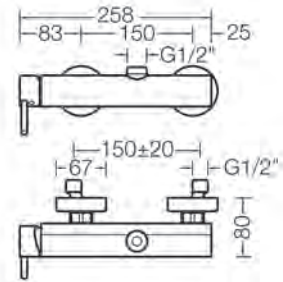

DEVIATORI

DEVIATORE INCASSO 2 VIE

Incluso corpo incasso



RICAMBI (PAG. 60-75)
3101072 - Cartuccia D. 35

codice	UM	min. ord.	conf.	cat.	prezzo (€)
● 1431014	NR	1	1	03	91,21

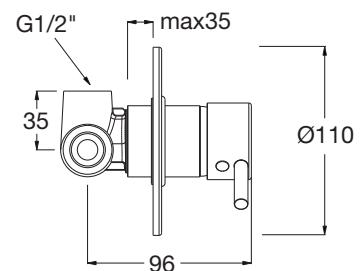

DEVIATORE INCASSO 3 VIE

Incluso corpo incasso



RICAMBI (PAG. 60-75)
3101072 - Cartuccia D. 35

codice	UM	min. ord.	conf.	cat.	prezzo (€)
● 1431017	NR	1	1	03	140,15

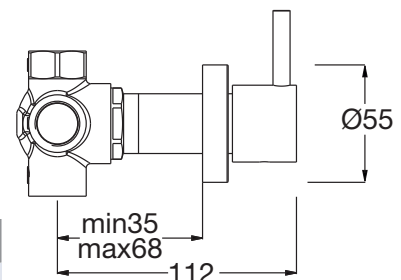

LINEA DOCCIA

COLONNE DOCCIA MULTIFUNZIONE

SELENE COLONNA DOCCIA MULTIFUNZIONE ALLUMINIO NERO OPACO

Colonna in alluminio (colore nero opaco) multifunzione anticalcare con miscelatore e **getto a cascata**. Senza copertura superiore. Portata 10 litri/min a 2 bar.

LINEA
DOCCIA

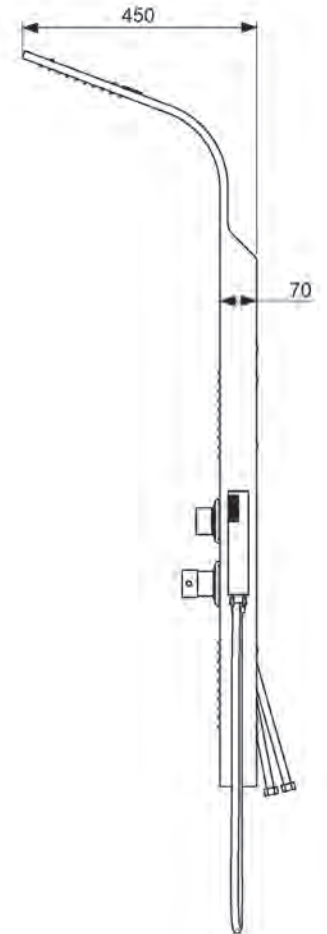
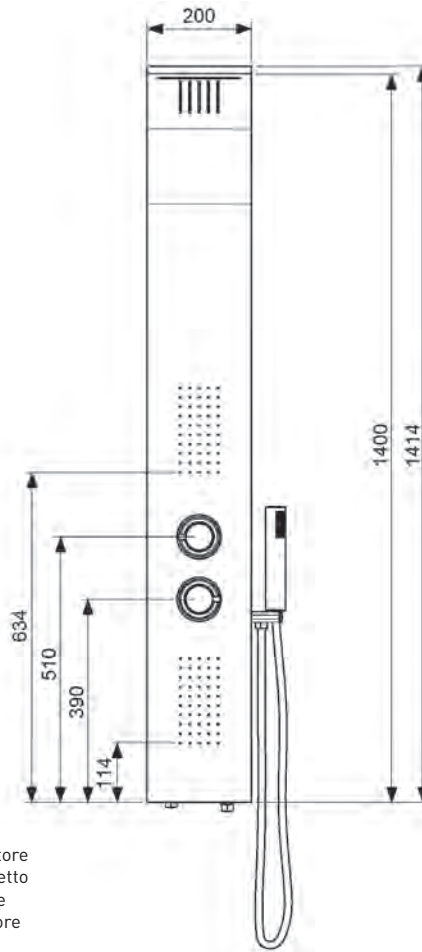

RICAMBI (PAG. 64, 125)
1413086 - Cartuccia deviatore
1413085 - Cartuccia rubinetto
1350993 - Soffione frontale
1350996 - Soffione superiore

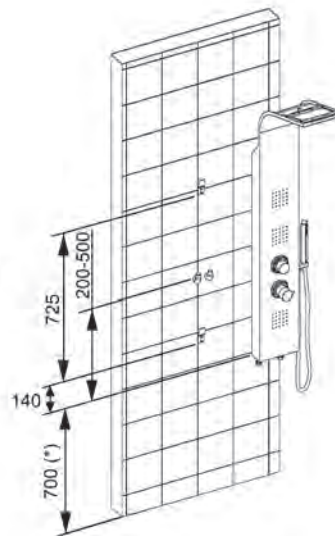
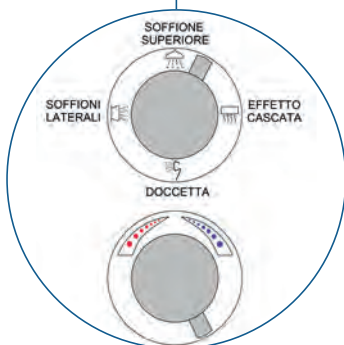

(*) Altezza consigliata da terra

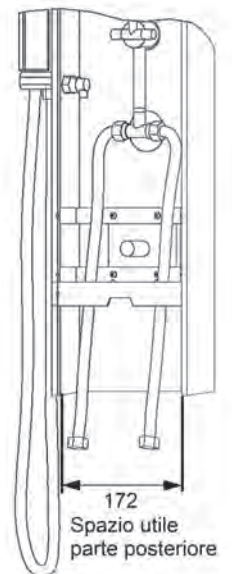

codice	UM	min. ord. conf.	cat.	prezzo (€)
● 1350912	NR	1	05	654,78

SELENE COLONNA DOCCIA MULTIFUNZIONE ALLUMINIO BIANCO OPACO

Colonna in alluminio (colore bianco opaco) multifunzione anticalcare con miscelatore e **getto a cascata**. Senza copertura superiore. Portata 10 litri/min a 2 bar.

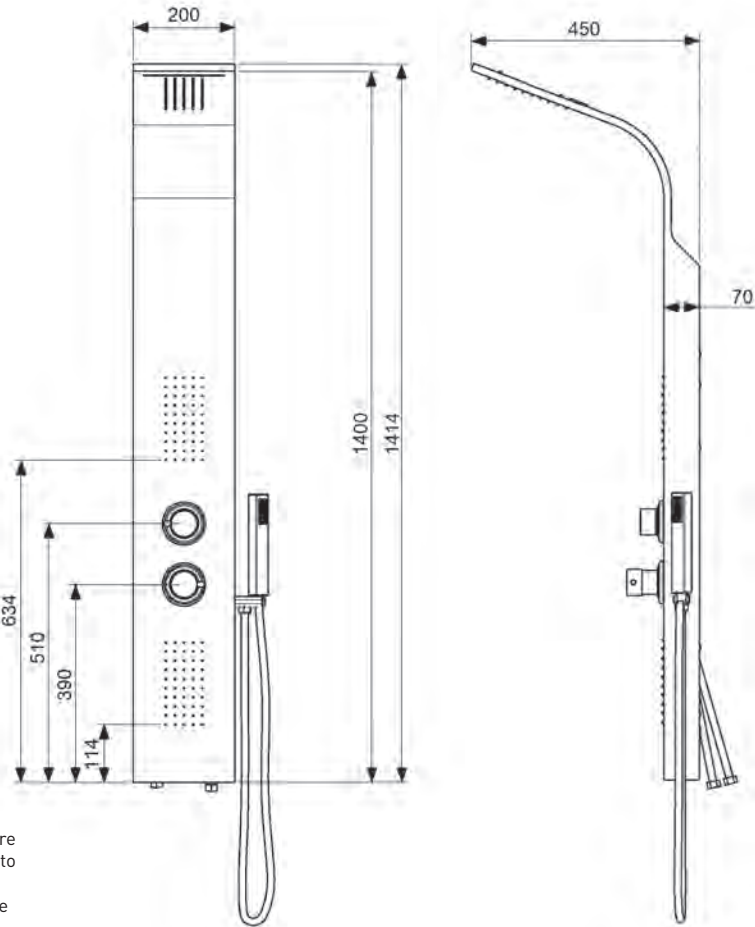

RICAMBI (PAG. 64, 125)
1413086 - Cartuccia deviatore
1413085 - Cartuccia rubinetto
1350993 - Soffione frontale
1350996 - Soffione superiore

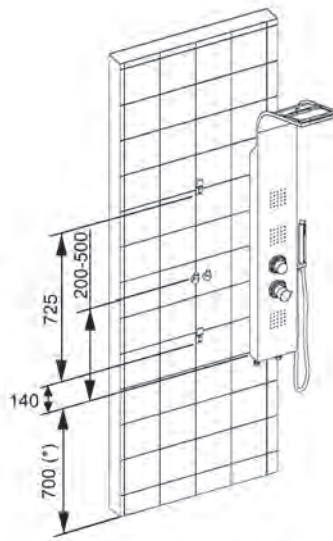
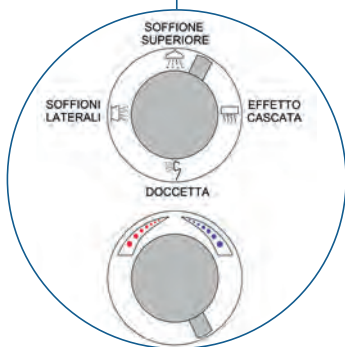

(*) Altezza consigliata da terra

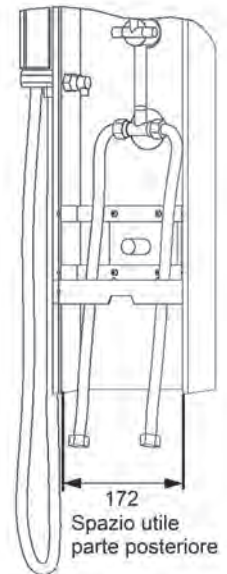

codice	UM	min. ord. conf.	cat.	prezzo (€)
● 1350903	NR	1	05	654,78

LINEA DOCCIA

COLONNE DOCCIA MULTIFUNZIONE

AURORA COLONNA DOCCIA MULTIFUNZIONE ACCIAIO LUCIDO

Colonna in acciaio lucido multifunzione anticalcare con miscelatore e **getto a cascata**. Senza copertura superiore. Portata 10 litri/min a 2 bar.

LINEA
DOCCIA

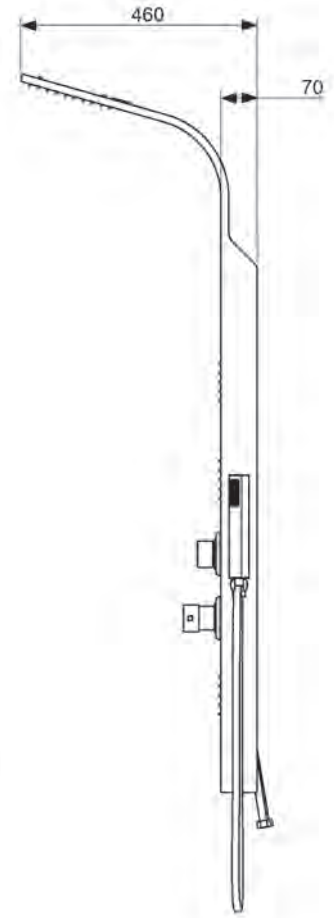
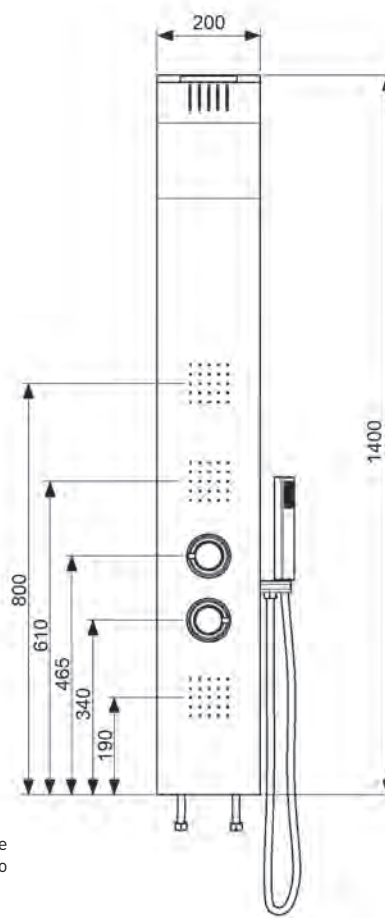

- RICAMBI (PAG. 64, 125)**
1413086 - Cartuccia deviatore
1413085 - Cartuccia rubinetto
1350999 - Soffione frontale
1350996 - Soffione superiore

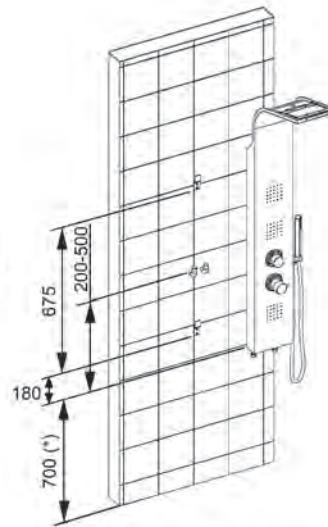
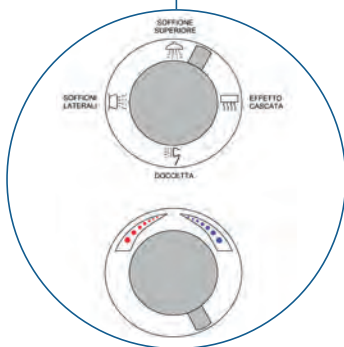

(*) Altezza consigliata da terra

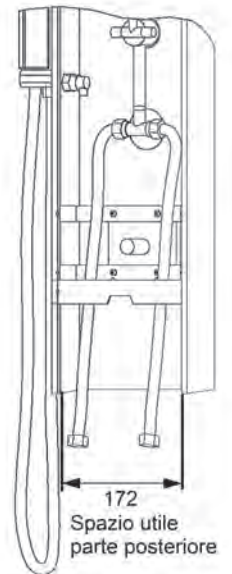

codice	UM	min. ord. conf.	cat.	prezzo (€)
● 1350913	NR	1	05	564,77

IRIDE COLONNA DOCCIA MULTIFUNZIONE ACCIAIO LUCIDO

Colonna in acciaio lucido multifunzione anticalcare con miscelatore. Senza copertura superiore.
Portata 10 litri/min a 2 bar.

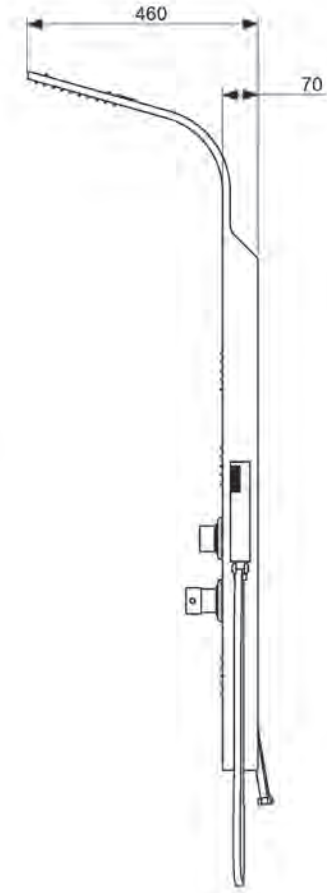
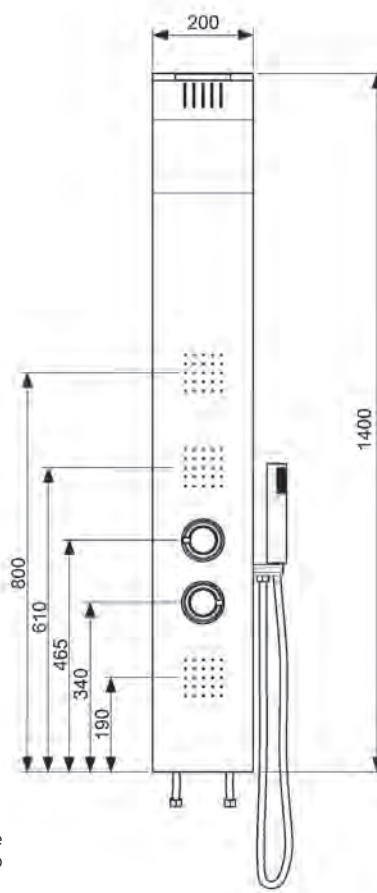

- RICAMBI (PAG. 64, 125)**
1413084 - Cartuccia deviatore
1413085 - Cartuccia rubinetto
1350999 - Soffione frontale
1350998 - Soffione superiore

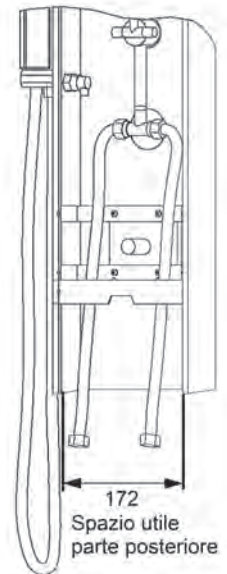
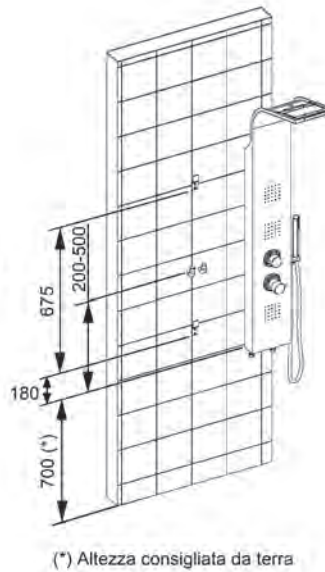
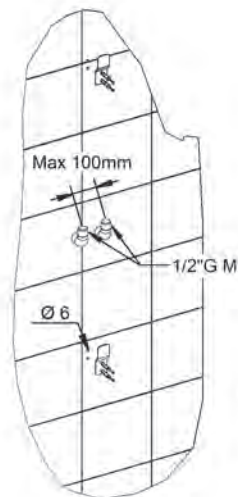
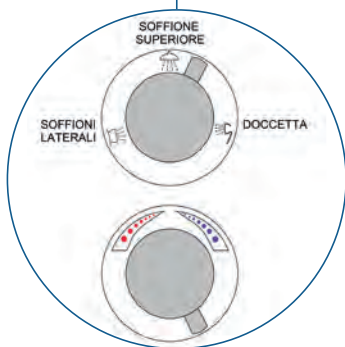

codice	UM	min. ord. conf.	cat.	prezzo (€)
● 1350902	NR	1	05	511,58

LINEA DOCCIA

COLONNE DOCCIA MULTIFUNZIONE

MINERVA COLONNA DOCCIA MULTIFUNZIONE ACCIAIO LUCIDO

Colonna in acciaio lucido multifunzione anticalcare con miscelatore, senza soffioni laterali. Senza copertura superiore. Portata 10 litri/min. a 2 bar.

LINEA
DOCCIA

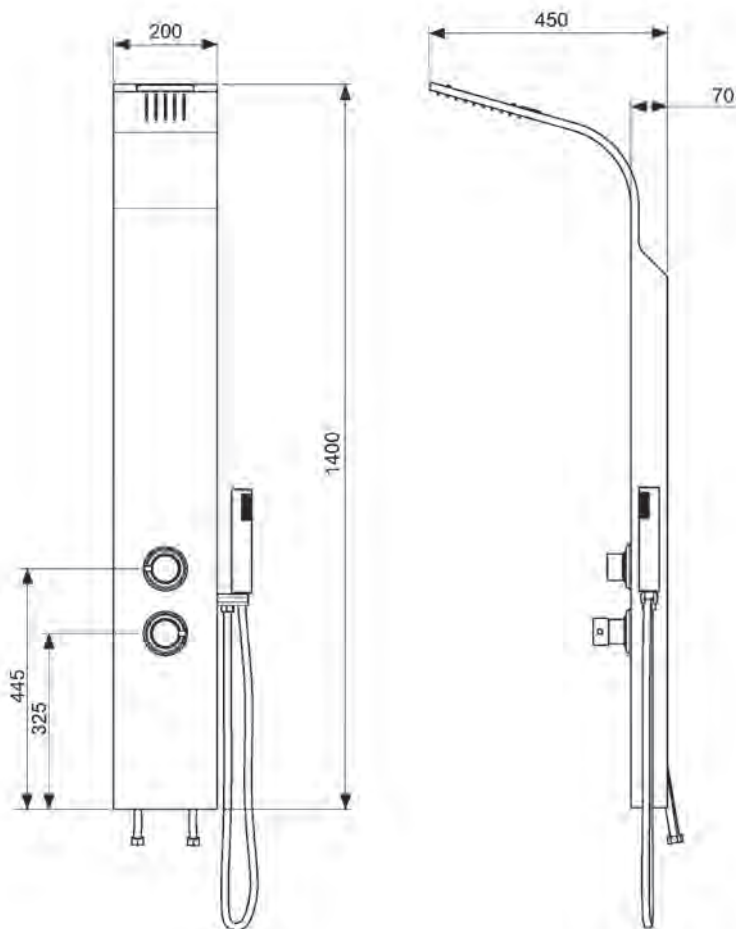

RICAMBI (PAG. 64)
1413095 - Cartuccia deviatore
1413085 - Cartuccia rubinetto

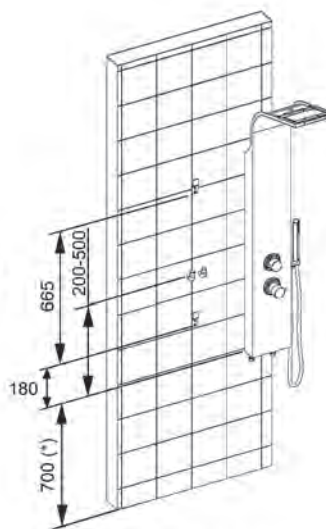
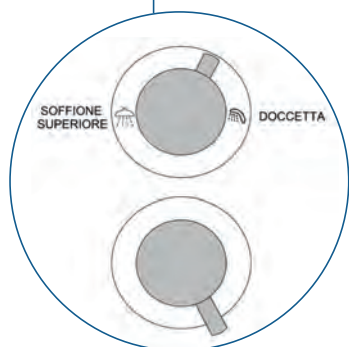

(*) Altezza consigliata da terra

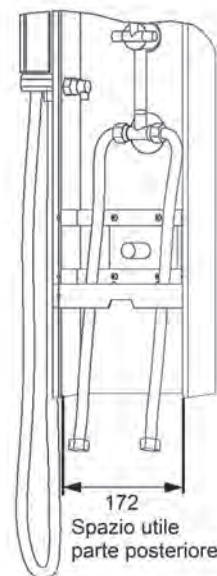

codice	UM	min. ord. conf.	cat.	prezzo (€)
● 1350918	NR	1	05	491,10

DIANA COLONNA DOCCIA MULTIFUNZIONE ALLUMINIO NERO OPACO

Colonna in alluminio (colore nero opaco) multifunzione anticalcare con miscelatore e **getto a cascata**. Senza copertura superiore. Portata 10 litri/min a 2 bar.

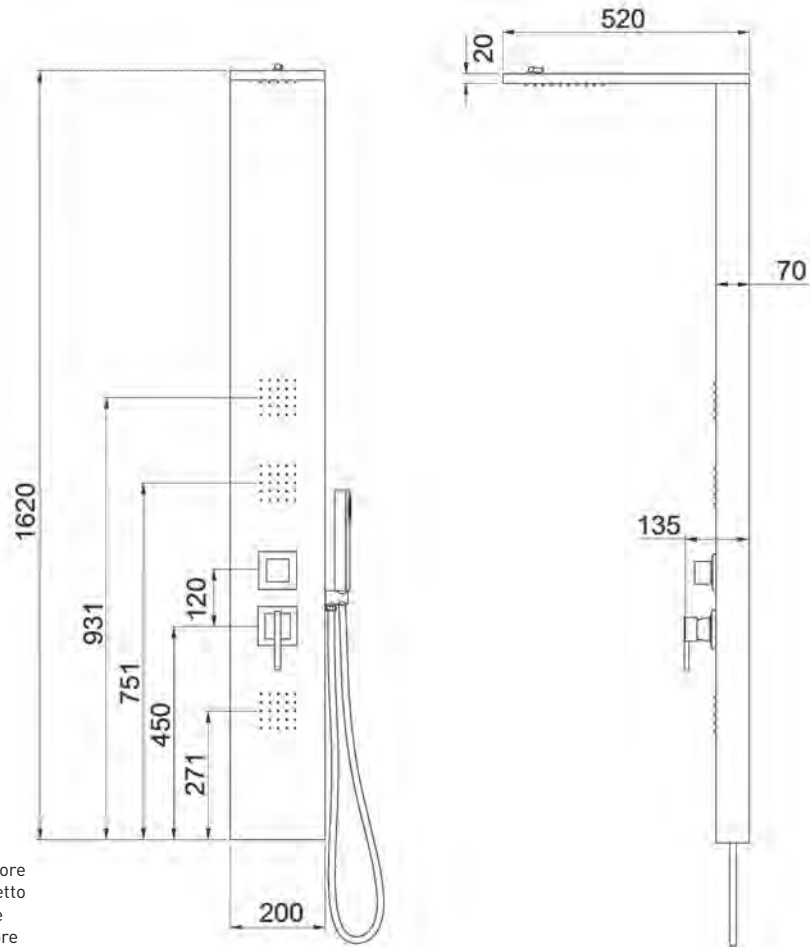

RICAMBI (PAG. 64, 125)
 1413091 - Cartuccia deviatore
 1413085 - Cartuccia rubinetto
 1350999 - Soffione frontale
 1350996 - Soffione superiore

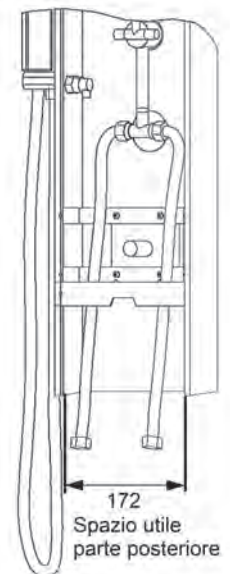
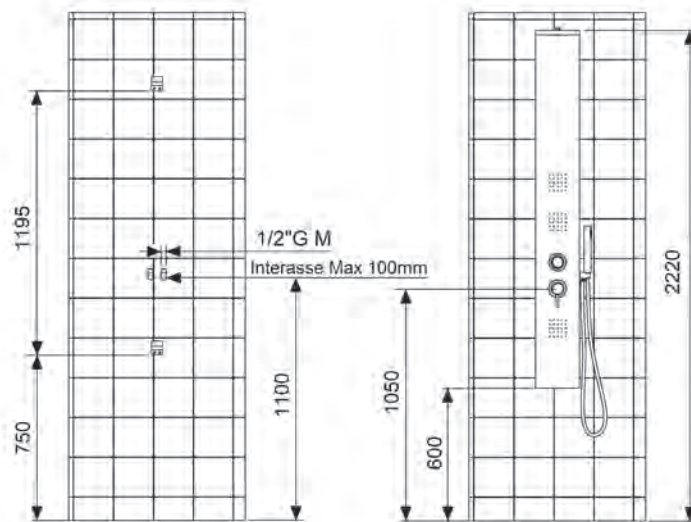
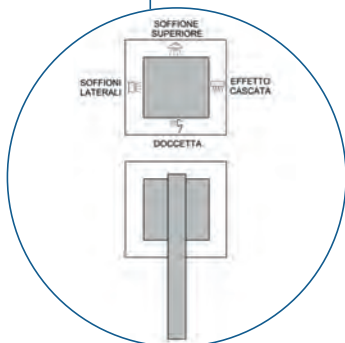

codice	UM	min. ord. conf.	cat.	prezzo (€)
● 1350917	NR	1	05	736,64

LINEA DOCCIA

COLONNE DOCCIA MULTIFUNZIONE

FLORA COLONNA DOCCIA MULTIFUNZIONE ACCIAIO LUCIDO

Colonna in acciaio lucido multifunzione anticalcare con miscelatore e **getto a cascata**. Senza copertura superiore. Portata 10 litri/min a 2 bar.

LINEA
DOCCIA

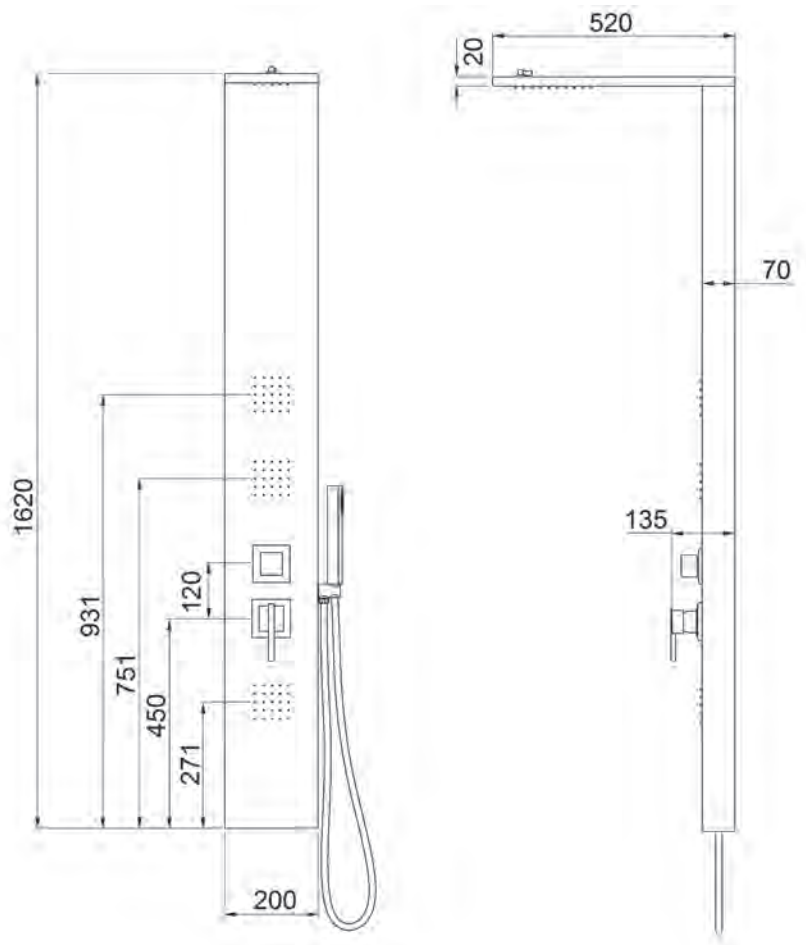

RICAMBI (PAG. 64, 125)
1413091 - Cartuccia deviatore
1413085 - Cartuccia rubinetto
1350999 - Soffione frontale
1350996 - Soffione superiore

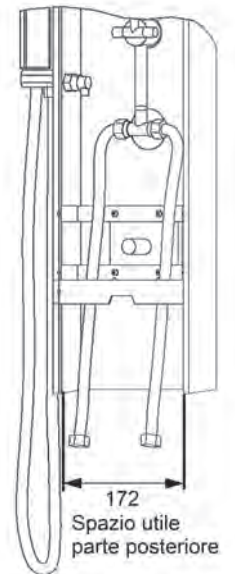
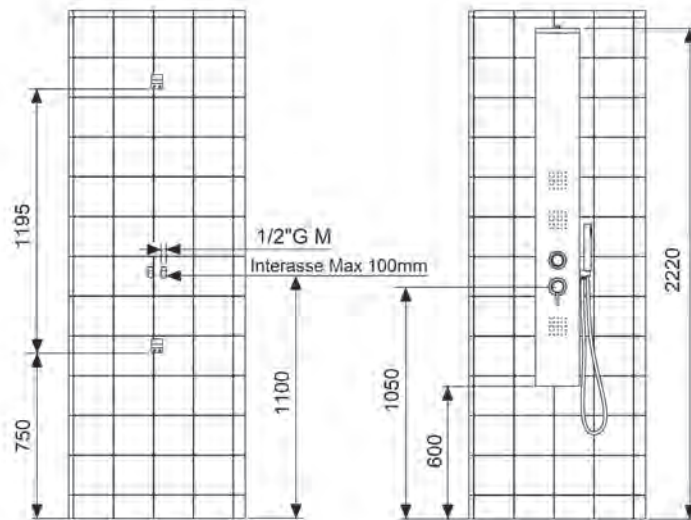
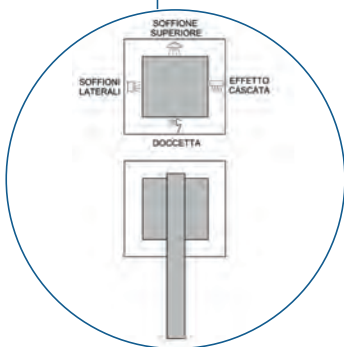

codice	UM	min. ord. conf.	cat.	prezzo (€)
● 1350907	NR	1	05	757,15

ATENA COLONNA DOCCIA MULTIFUNZIONE ACCIAIO LUCIDO

Colonna in acciaio lucido multifunzione anticalcare con miscelatore. Senza copertura superiore.
Portata 10 litri/min a 2 bar.

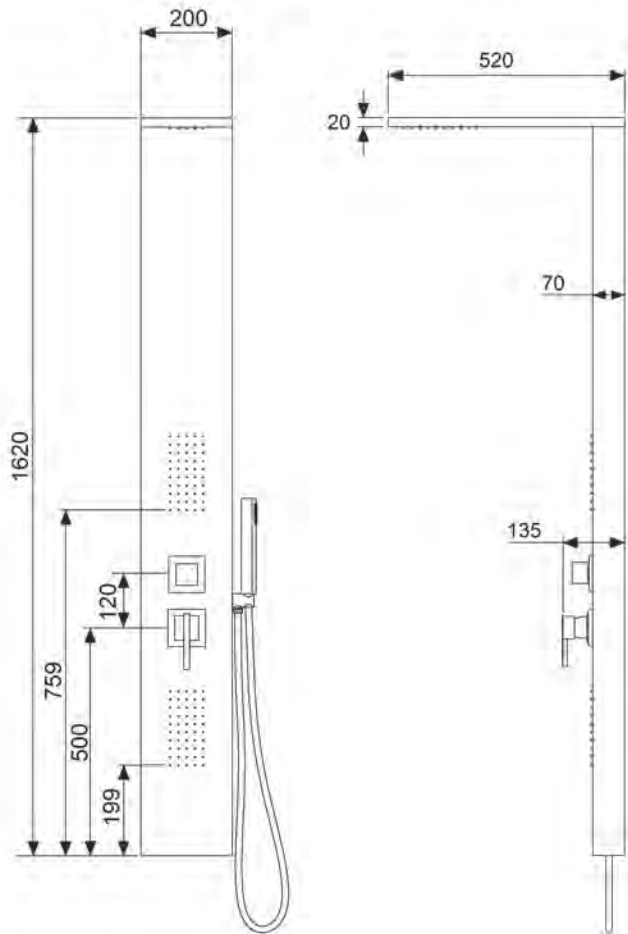

- RICAMBI (PAG. 64, 125)**
1413089 - Cartuccia deviatore
1413085 - Cartuccia rubinetto
1350993 - Soffione frontale
1350998 - Soffione superiore

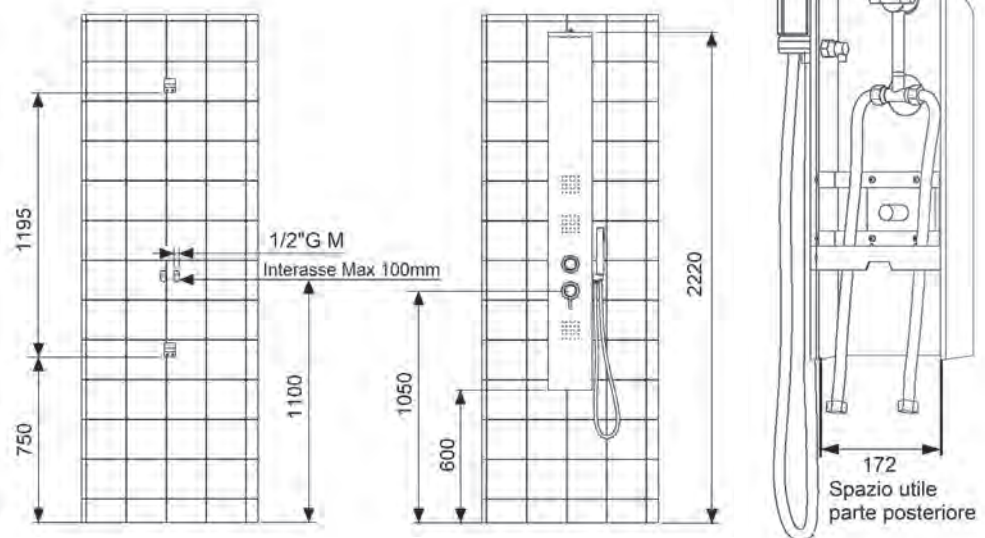
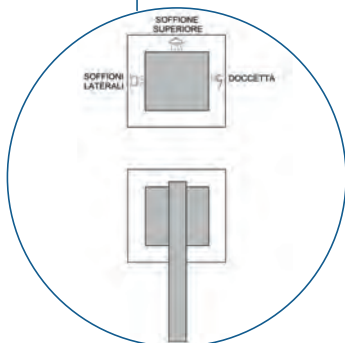

codice	UM	min. ord. conf.	cat.	prezzo (€)
● 1350908	NR	1	05	748,93

LINEA DOCCIA

LINEA DOCCIA

NARCISO COLONNA DOCCIA CROMATA

Colonna doccia telescopica con doccetta rettangolare monogetto in ABS (1410036) e flessibile estensibile 150cm, attacco inferiore femmina 1/2", attacco soffione maschio 1/2".

LINEA DOCCIA



CON TERMOSTATICO QUADRATO

Euro 495,22

codice	descrizione	UM	pezzi	cat.	prezzo (€)
1350639	colonna	NR	1	05	232,00
1431024	mix con deviatore incorporato	NR	1	03	263,22



CON TERMOSTATICO BLISS TONDO COOL BODY

Euro 461,36

codice	descrizione	UM	pezzi	cat.	prezzo (€)
1350639	colonna	NR	1	05	232,00
1431016	mix con deviatore incorporato	NR	1	03	229,36



CON TERMOSTATICO

Euro 438,78

codice	descrizione	UM	pezzi	cat.	prezzo (€)
1350639	colonna	NR	1	05	232,00
1431021	mix con deviatore incorporato	NR	1	03	206,78



CON DOCCIA ESTERNO COOL BODY

Euro 407,20

codice	descrizione	UM	pezzi	cat.	prezzo (€)
1350639	colonna	NR	1	05	232,00
1431015	mix con deviatore incorporato	NR	1	03	175,20

CON FLESSIBILE

Euro 339,83

codice	descrizione	UM	pezzi	cat.	prezzo (€)
1350639	colonna	NR	1	05	232,00
1414009	deviatore MF 1/2"	NR	1	02	43,23
1414012	supporto inferiore	NR	1	02	55,76
1406015	flessibile 60 cm. 1/2"	NR	1	09	8,84

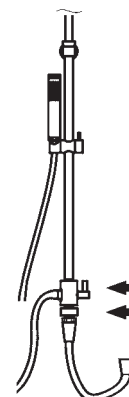
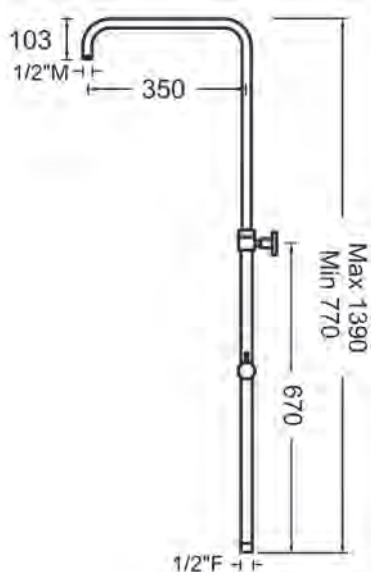

ATTENZIONE:
In fase di installazione rispettare l'ordine dei componenti:

← Deviatore
← Supporto a muro

SOFFIONE NON COMPRESO. Possibile abbinamento con i soffioni a pag.104-106-107

NARCISO COLONNA DOCCIA NERO OPACO

Colonna doccia telescopica con doccetta rettangolare monogetto in ottone e flessibile 150cm, attacco inferiore femmina 1/2", attacco soffione maschio 1/2".

1359639

nero
opaco



1431916

CON TERMOSTATICO BLISS TONDO COOL BODY

Euro 658,24

codice	descrizione	UM	pezzi	cat.	prezzo (€)
● 1359639	colonna nero opaco	NR	1	04	348,63
● 1431916	mix con deviatore incorporato nero opaco	NR	1	03	309,61



1431915

CON DOCCIA ESTERNO COOL BODY

Euro 585,11

codice	descrizione	UM	pezzi	cat.	prezzo (€)
● 1359639	colonna nero opaco	NR	1	04	348,63
● 1431915	mix con deviatore incorporato nero opaco	NR	1	03	236,48

NARCISO COLONNA DOCCIA SIMIL ACCIAIO

Colonna doccia telescopica con doccetta rettangolare monogetto in ottone e flessibile 150cm, attacco inferiore femmina 1/2", attacco soffione maschio 1/2".

1358639

simil
acciaio



1431816

CON TERMOSTATICO BLISS TONDO COOL BODY

Euro 695,06

codice	descrizione	UM	pezzi	cat.	prezzo (€)
● 1358639	colonna simil acciaio	NR	1	04	373,98
● 1431816	mix con deviatore incorporato simil acciaio	NR	1	03	321,08



1431815

CON DOCCIA ESTERNO COOL BODY

Euro 619,27

codice	descrizione	UM	pezzi	cat.	prezzo (€)
● 1358639	colonna simil acciaio	NR	1	04	373,98
● 1431815	mix con deviatore incorporato simil acciaio	NR	1	03	245,29

SOFFIONE NON COMPRESO. Possibile abbinamento con i soffioni a pag. 104

LINEA DOCCIA

MAGNOLIA COLONNA DOCCIA

Colonna doccia telescopica con doccetta rettangolare monogetto in ABS (1410036) e flessibile estensibile 150cm, attacco inferiore femmina 1/2", attacco soffione maschio 1/2".

LINEA DOCCIA



1350659



1431024

CON TERMOSTATICO QUADRATO

Euro 509,62

codice	descrizione	UM	pezzi	cat.	prezzo (€)
1350659	colonna	NR	1	05	246,40
1431024	mix con deviatore incorporato	NR	1	03	263,22



1431016

CON TERMOSTATICO BLISS TONDO COOL BODY

Euro 475,76

codice	descrizione	UM	pezzi	cat.	prezzo (€)
1350659	colonna	NR	1	05	246,40
1431016	mix con deviatore incorporato	NR	1	03	229,36



1431021

CON TERMOSTATICO

Euro 453,18

codice	descrizione	UM	pezzi	cat.	prezzo (€)
1350659	colonna	NR	1	05	246,40
1431021	mix con deviatore incorporato	NR	1	03	206,78



1431015

CON DOCCIA ESTERNO COOL BODY

Euro 421,60

codice	descrizione	UM	pezzi	cat.	prezzo (€)
1350659	colonna	NR	1	05	246,40
1431015	mix con deviatore incorporato	NR	1	03	175,20

CON FLESSIBILE

Euro 354,23

codice	descrizione	UM	pezzi	cat.	prezzo (€)
1350659	colonna	NR	1	05	246,40
1414009	deviatore MF 1/2"	NR	1	02	43,23
1414012	supporto inferiore	NR	1	02	55,76
1406015	flessibile 60 cm. 1/2"	NR	1	09	8,84

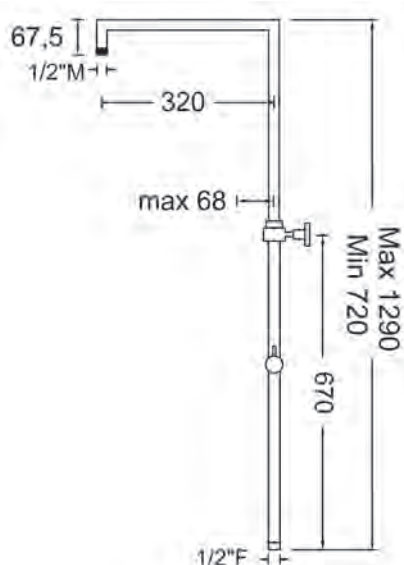

1414009



1414012



ATTENZIONE:
In fase di installazione rispettare l'ordine dei componenti:

← Deviatore
← Supporto a muro

SOFFIONE NON COMPRESO. Possibile abbinamento con i soffioni a pag. 104-106-107

Colonna doccia telescopica con doccetta cilindrica monogetto in ABS (1412008) e flessibile estensibile 150cm, attacco inferiore femmina 1/2", attacco soffione maschio 1/2".



1350649



1431016

CON TERMOSTATICO BLISS TONDO COOL BODY

Euro 461,36

codice	descrizione	UM	pezzi	cat.	prezzo (€)
1350649	colonna	NR	1	05	232,00
1431016	mix con deviatore incorporato	NR	1	03	229,36



1431021

CON TERMOSTATICO

Euro 438,78

codice	descrizione	UM	pezzi	cat.	prezzo (€)
1350649	colonna	NR	1	05	232,00
1431021	mix con deviatore incorporato	NR	1	03	206,78



1431015

CON DOCCIA ESTERNO COOL BODY

Euro 407,20

codice	descrizione	UM	pezzi	cat.	prezzo (€)
1350649	colonna	NR	1	05	232,00
1431015	mix con deviatore incorporato	NR	1	03	175,20

CON FLESSIBILE

Euro 339,83

codice	descrizione	UM	pezzi	cat.	prezzo (€)
1350649	colonna	NR	1	05	232,00
1414009	deviatore MF 1/2"	NR	1	02	43,23
1414012	supporto inferiore	NR	1	02	55,76
1406015	flessibile 60 cm. 1/2"	NR	1	09	8,84

1414009



1414012

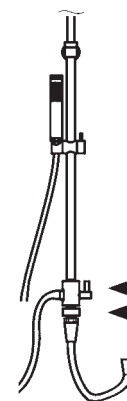

ATTENZIONE:
In fase di installazione rispettare l'ordine dei componenti:

← Deviatore
← Supporto a muro

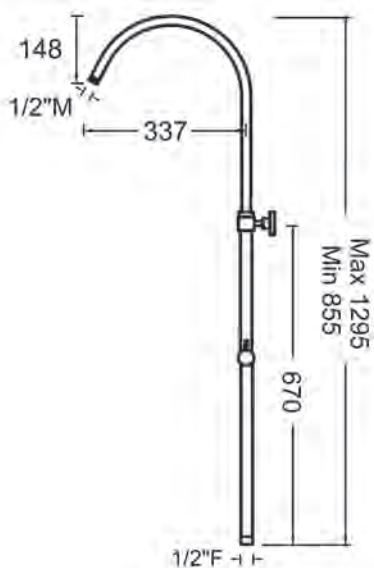

SOFFIONE NON COMPRESO. Possibile abbinamento con i soffioni a pag. 104-106-107

LINEA DOCCIA

SALISCENDI

CRYSTAL

Set composto da: asta doccia in ottone 30x10 mm. da 70 cm, doccetta CRYSTAL monogetto in ABS (1410036), flessibile doppia aggiratura da 150 cm. (1406003), kit fissaggio.

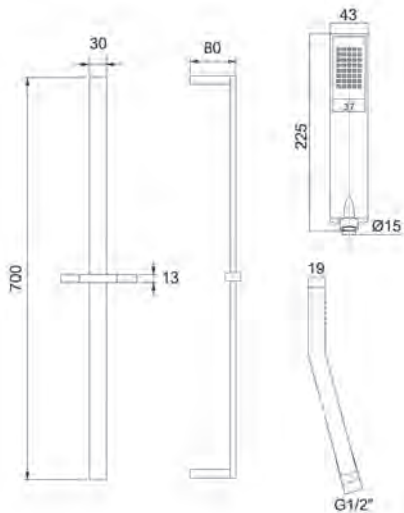

LINDA 3 GETTI

Set composto da: asta doccia completamente in ottone D.20 mm. da 90 cm. con un supporto regolabile, doccetta LINDA a 3 getti D.112 mm. (1410028*), flessibile plastico silver da 150 cm. (1407003*), kit di fissaggio.
*solo versione cromo

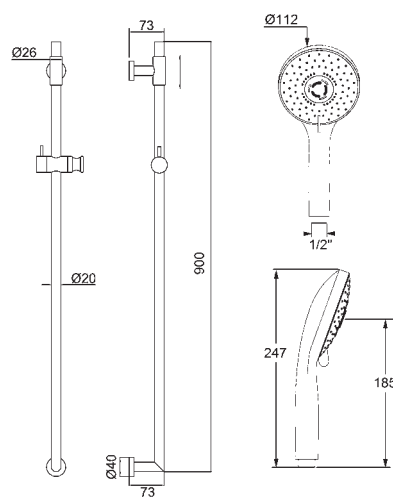

CINDY 3 GETTI

Set composto da: asta doccia completamente in ottone D.20 da 76 cm., doccetta CINDY a 3 getti D.125 mm. (1410021), flessibile doppia aggiratura da 150 cm. (1406003), kit di fissaggio.

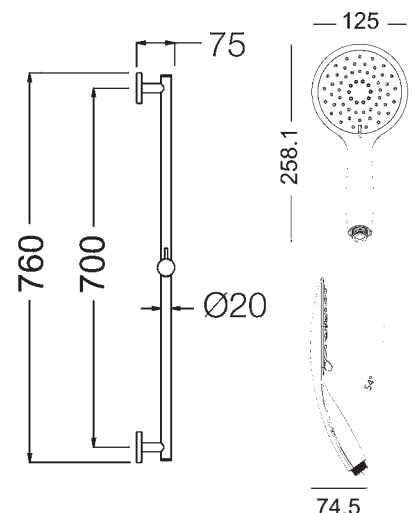

codice	UM	min. ord.	conf.	cat.	prezzo (€)
● 1323001	NR	1	10	01	144,94

codice	finitura	UM	min. ord.	conf.	cat.	prezzo (€)
● 1319001	cromo	NR	1	10	01	166,12
● 1319901	nero opaco	NR	1	1	01	332,81
1319801	simil acciaio	NR	1	1	01	279,68

codice	UM	min. ord.	conf.	cat.	prezzo (€)
● 1316001	NR	1	1	01	131,67

KELLY 5 GETTI

Set composto da: asta doccia in inox D.25 mm. da 71 cm. con un supporto regolabile, portasapone cromato, doccetta Marine a 5 getti D.90 mm. (1410003), flessibile doppia aggraffatura da 150 cm. (1406003), kit di fissaggio.

RICAMBI (PAG. 123)
1411004 - Corsore



ELISA 5 GETTI

Set composto da: asta doccia in inox D.25 mm. da 71 cm. Con entrambi i supporti regolabili, portasapone cromato, doccetta a 5 getti D.110 mm., flessibile doppia aggraffatura da 150 cm. (1406003), kit di fissaggio.

RICAMBI (PAG. 123)
1411004 - Corsore



DIANA 5 GETTI

Set composto da: asta doccia in inox D.25 mm. da 58 cm., portasapone cromato, doccetta DIANA a 5 getti D.112 mm. (1410034), flessibile doppia aggraffatura da 150 cm. (1406003), kit di fissaggio.

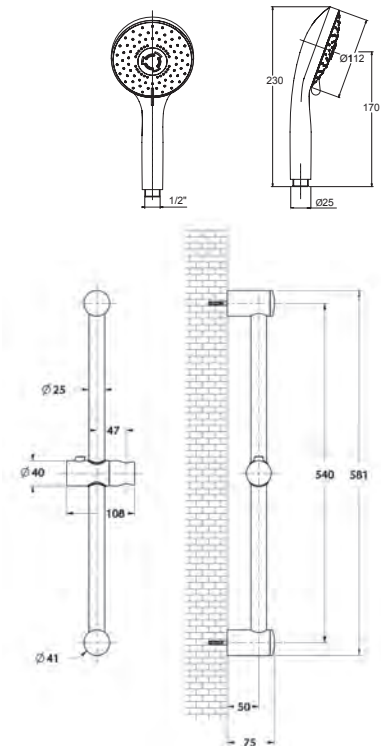
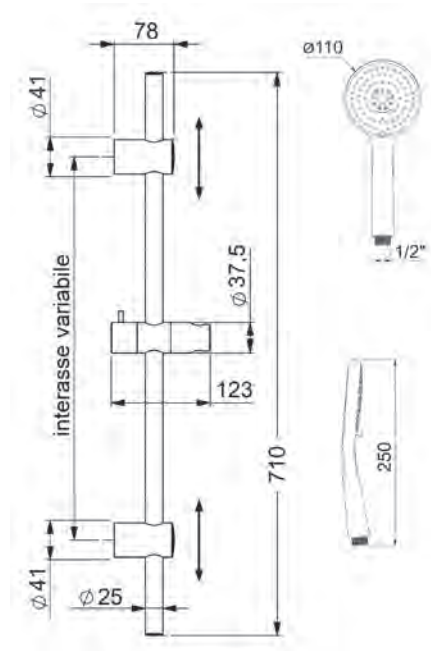
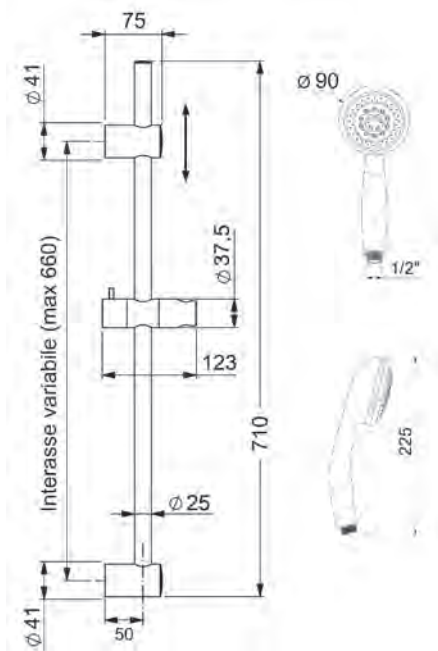

codice	UM	min. ord.	conf.	cat.	prezzo (€)
● 1311001	NR	1	10	01	70,62

codice	UM	min. ord.	conf.	cat.	prezzo (€)
● 1320001	NR	1	10	01	67,91

codice	UM	min. ord.	conf.	cat.	prezzo (€)
● 1321001	NR	1	10	01	48,51

LINEA DOCCIA

SALISCENDI

MARINE 5 GETTI

Set composto da: asta doccia in inox D.25 mm. da 65 cm., portasapone cromato, doccetta MARINE a 5 getti D.90 mm. (1410003), flessibile da 150 cm., kit di fissaggio.

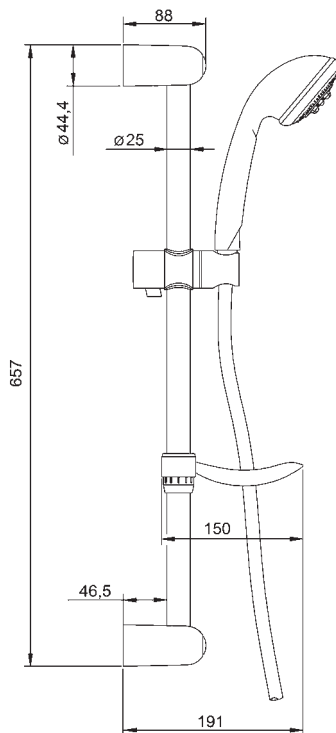

	codice	UM	min. ord.	conf.	cat.	prezzo (€)
●	1322001	NR	1	10	01	36,63

GROHE RAINSHOWER SMARTACTIVE 150, 3 GETTI

Set composto da: asta doccia completamente metallica D.25 mm. da 90 cm., doccetta RAINSHOWER SMARTACTIVE a 3 getti D 150 mm. con portata limitata a 9,5 lt/min., mensola porta oggetti 210x100 mm.

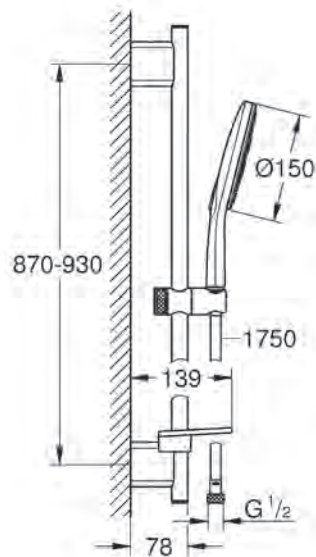

	codice	UM	min. ord.	conf.	cat.	prezzo (€)
●	26594000	NR	1	12	11	403,68

GROHE TEMPESTA 110, 2 GETTI

Set composto da: asta doccia metallica D.22 mm. da 60 cm. doccetta TEMPESTA a 2 getti D. 110 mm. (27597003), flessibile cromo da 175 cm., kit fissaggio.

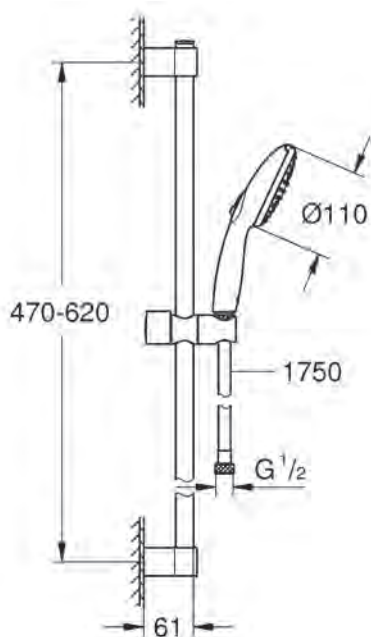

GROHE TEMPESTA 110, 3 GETTI

Set composto da: asta doccia metallica D.22 mm. da 60 cm., doccetta TEMPESTA a 3 getti D. 110 mm. (28261003), flessibile cromo da 175 cm., kit fissaggio.

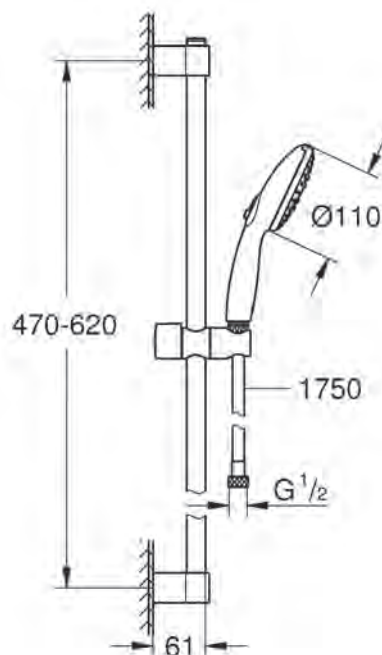

codice	UM	min. ord.	conf.	cat.	prezzo (€)
● 27598003	NR	1	24	11	88,36

codice	UM	min. ord.	conf.	cat.	prezzo (€)
● 27794003	NR	1	20	11	101,70

LINEA DOCCIA

SOFFIONI DOCCIA OTTONE

SQUARE

Anticalcare ed ispezionabile.
Portata litri/min: **12**



codice	dimensioni (mm)	finitura	UM	min. ord.	conf.	cat.	prezzo (€)
● 1403018	200	cromo	NR	1	10	01	117,15
● 1403918	200	nero opaco	NR	1	1	01	175,33
● 1403818	200	simil acciaio	NR	1	1	01	193,55
● 1403057	250	cromo	NR	1	6	01	154,84
● 1403957	250	nero opaco	NR	1	1	01	247,07
● 1403857	250	simil acciaio	NR	1	1	01	277,04
● 1403042	300	cromo	NR	1	5	01	209,22

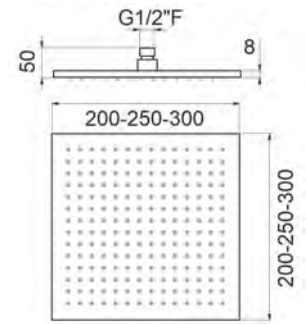

PITCH RETTANGOLARE

Anticalcare ed ispezionabile.
Portata litri/minuto: **12**



codice	dimensioni (mm)	UM	min. ord.	conf.	cat.	prezzo (€)
● 1403020	245x140	NR	1	10	01	140,18
● 1403060	340x220	NR	1	1	01	302,73

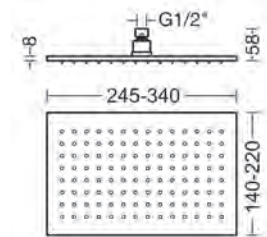

ROUND

Anticalcare ed ispezionabile.
Portata litri/minuto: **14**

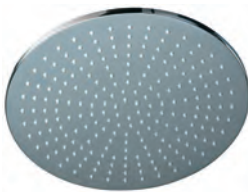

codice	dimensioni (mm)	finitura	UM	min. ord.	conf.	cat.	prezzo (€)
● 1403021	200	cromo	NR	1	10	01	92,07
● 1403921	200	nero opaco	NR	1	1	01	167,38
● 1403821	200	simil acciaio	NR	1	1	01	185,96
● 1403052	250	cromo	NR	1	6	01	133,88
● 1403952	250	nero opaco	NR	1	1	01	227,14
● 1403852	250	simil acciaio	NR	1	1	01	278,95
● 1403037	300	cromo	NR	1	5	01	184,11

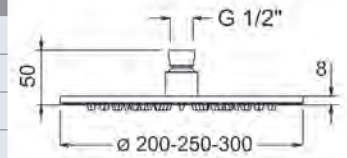

SHOWER BELL

Non ispezionabile.
Portata litri/minuto: **15,9**



codice	dimensioni (mm)	finitura	UM	min. ord.	conf.	cat.	prezzo (€)
● 1403024	208	nero opaco	NR	1	8	01	170,94



SHOWER BELL NERO OPACO

Anticalcare ed ispezionabile.
Portata litri/minuto: **15,9**



codice	dimensioni (mm)	finitura	UM	min. ord.	conf.	cat.	prezzo (€)
● 1403924	200	nero opaco	NR	1	1	01	337,76



SQUARE SOFFIONE A MURO C/CASCATA

Anticalcare ed ispezionabile, parte superiore chiusa.
Portata litri/minuto: **6,6** pioggia
7,7 cascata

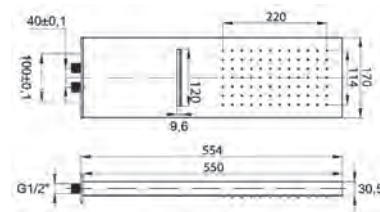

codice	dimensioni (mm)	UM	min. ord.	conf.	cat.	prezzo (€)
● 1403085	550x170x30	NR	1	1	15	404,67

SQUARE SOFFIONE A MURO SENZA CASCATA

Anticalcare ed ispezionabile, parte superiore chiusa.
Portata litri/minuto: **6,6** pioggia

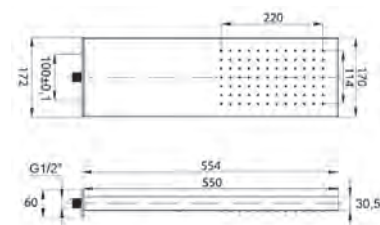

codice	dimensioni (mm)	UM	min. ord.	conf.	cat.	prezzo (€)
● 1403086	550x170x30	NR	1	1	15	339,40

QUADRO A MURO CON CASCATA

Anticalcare, senza copertura superiore.
Portata litri/minuto: **6**

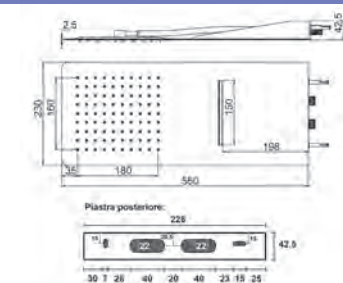

codice	dimensioni (mm)	UM	min. ord.	conf.	cat.	prezzo (€)
● 1403050	550x230x2,5	NR	1	3	02	390,46

QUADRO A MURO SENZA CASCATA

Anticalcare, senza copertura superiore.
Portata litri/minuto: **6**

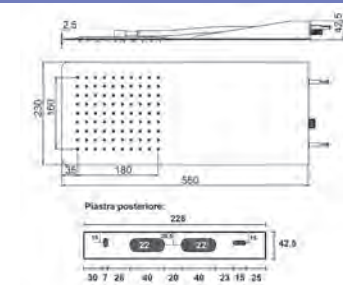

codice	dimensioni (mm)	UM	min. ord.	conf.	cat.	prezzo (€)
● 1403051	550x230x2,5	NR	1	3	02	373,69

LINEA DOCCIA

SOFFIONI DOCCIA ACCIAIO

SQUARE

Anticalcare
Portata litri/minuto: **9,3**



codice	dimensioni (mm)	UM	min. ord.	conf.	cat.	prezzo (€)
● 1403064	150	NR	1	15	06	39,02
● 1403035	200	NR	1	12	06	45,83
● 1403059	250	NR	1	7	06	68,94
● 1403041	300	NR	1	6	06	90,72
● 1403084	400	NR	1	1	06	167,83

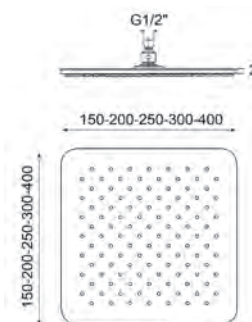

PLENTY SQUARE

Angoli smussati. Anticalcare
Portata litri/minuto: **8,1**



codice	dimensioni (mm)	UM	min. ord.	conf.	cat.	prezzo (€)
● 1403054	200	NR	1	12	06	123,37
● 1403068	250	NR	1	7	06	176,26
● 1403056	300	NR	1	5	06	226,30

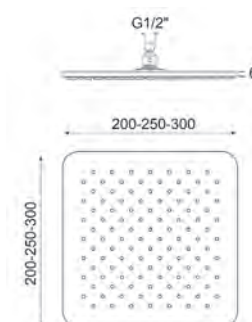

PITCH RETTANGOLARE

Ultrasottile. Anticalcare.
Portata litri/minuto: **7,3**



codice	dimensioni (mm)	UM	min. ord.	conf.	cat.	prezzo (€)
● 1403065	300x200	NR	1	8	06	166,72

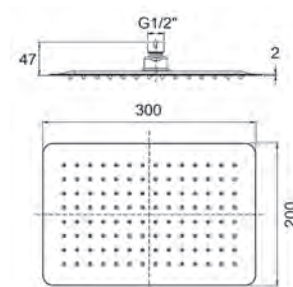

ROUND

Anticalcare
Portata litri/minuto: **9,6**



codice	dimensioni (mm)	UM	min. ord.	conf.	cat.	prezzo (€)
● 1403063	150	NR	1	15	06	39,02
● 1403033	200	NR	1	12	06	44,93
● 1403058	250	NR	1	7	06	68,04
● 1403034	300	NR	1	6	06	86,18
● 1403083	400	NR	1	1	06	163,30

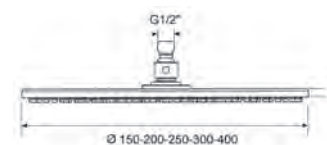

PLENTY ROUND

Anticalcare
Portata litri/minuto: **6,5**



	codice	dimensioni (mm)	UM	min. ord.	conf.	cat.	prezzo (€)
●	1403053	200	NR	1	12	06	113,87
●	1403066	250	NR	1	7	06	169,13
●	1403055	300	NR	1	5	06	219,10

ROUND JETS

Getto ultra soft con n.558 ugelli, anticalcare.
Portata litri/minuto: **7,2**

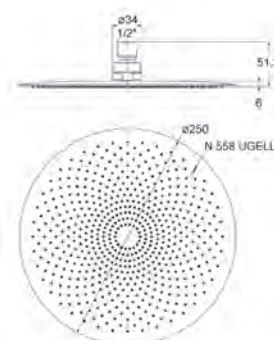

	codice	dimensioni (mm)	UM	min. ord.	conf.	cat.	prezzo (€)
●	1403087	250	NR	1	06	06	194,40

SOFFIONI DOCCIA ABS

ECO SQUARE

Anticalcare ed ispezionabile
Portata litri/minuto: **16**

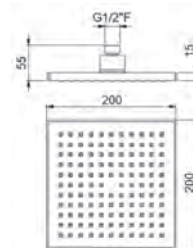

	codice	dimensioni (mm)	UM	min. ord.	conf.	cat.	prezzo (€)
●	1403046	200	NR	1	02	02	43,49

ECO ROUND

Anticalcare ed ispezionabile
Portata litri/minuto: **14,5**

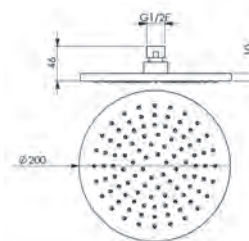

	codice	dimensioni (mm)	UM	min. ord.	conf.	cat.	prezzo (€)
●	1403047	200	NR	1	02	02	32,03

LINEA DOCCIA

SOFFIONI DOCCIA ECONOMICI

TORINO 1 FUNZIONE



In ottone a 1 funzione.
Portata litri/minuto: **17,9**



codice	dimensioni (mm)	UM	min. ord. conf.	cat.	prezzo (€)
● 1403040	70	NR	1	02	12,24

COMO 1 FUNZIONE



In ottone a 1 funzione
Portata litri/minuto: **17**

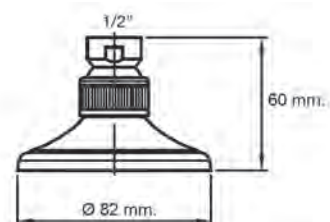

codice	dimensioni (mm)	UM	min. ord. conf.	cat.	prezzo (€)
● 1403009	82	NR	1	06	17,57

LISBONA 1 FUNZIONE



In ABS cromato
Portata litri/minuto: **34**

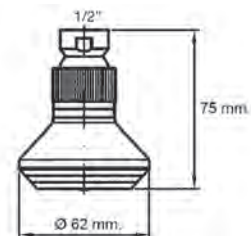

codice	dimensioni (mm)	UM	min. ord. conf.	cat.	prezzo (€)
● 1403048	62	NR	1	06	13,50

RIMINI 1 FUNZIONE



In ABS cromato
Portata litri/minuto: **9**



codice	dimensioni (mm)	UM	min. ord. conf.	cat.	prezzo (€)
● 1403017	90	NR	1	02	18,33

GRETA 3 FUNZIONI



In ABS cromato
Portata litri/minuto: **10**

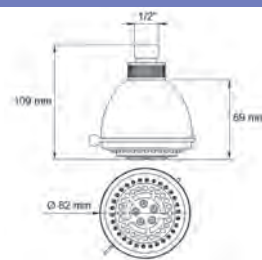

codice	dimensioni (mm)	UM	min. ord. conf.	cat.	prezzo (€)
● 1403006	80	NR	1	02	10,91

PARIGI 5 FUNZIONI



Anticalcare
In ABS cromato
Portata litri/minuto: **15**

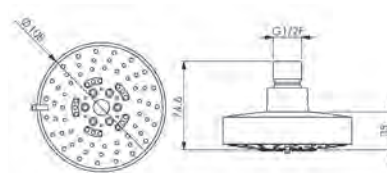

codice	dimensioni (mm)	UM	min. ord. conf.	cat.	prezzo (€)
● 1403049	108	NR	1	02	26,04

BRACCI DOCCIA

BRACCIO DOCCIA CON DEVIATORE



DEVIATORE

In ottone Ø 20 mm
Il deviatore si attiva tirando con cura verso il basso il flessibile. Chiudendo l'acqua, in assenza di pressione, il deviatore torna in automatico sul soffione.

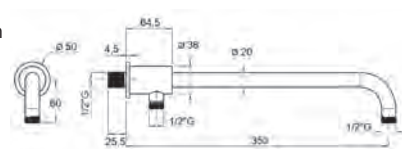

codice	dimensioni (cm)	UM	min. ord. conf.	cat.	prezzo (€)
● 1405036	30 + 6 (dev.)	NR	1	02	143,28

MODENA



In ottone

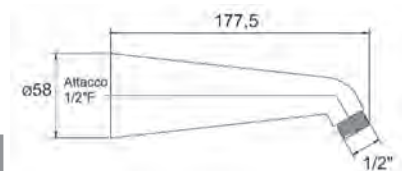

codice	dimensioni (cm)	UM	min. ord. conf.	cat.	prezzo (€)
● 1405001	18	NR	1	02	37,33

LINEA DOCCIA

BRACCI DOCCIA

VIGEVANO

In ottone
Ø 18 mm



●	codice	dimensioni (cm)	UM	min. ord.	conf.	cat.	prezzo (€)
●	1405004	20	NR	1	10	06	15,70
●	1405021	25	NR	1	10	06	17,46
●	1405005	30	NR	1	10	06	18,83

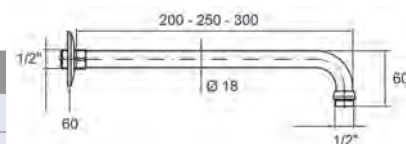

RAVENNA

In ottone
Ø 22 mm



●	codice	dimensioni (cm)	finitura	UM	min. ord.	conf.	cat.	prezzo (€)
●	1405006	30	cromo	NR	1	02	34,48	
●	1405906	30	nero opaco	NR	1	02	89,93	
●	1405806	30	simil acciaio	NR	1	02	100,10	
●	1405035	35	cromo	NR	1	02	38,25	
●	1405935	35	nero opaco	NR	1	02	98,16	
●	1405835	35	simil acciaio	NR	1	02	114,58	
●	1405019	40	cromo	NR	1	02	47,63	

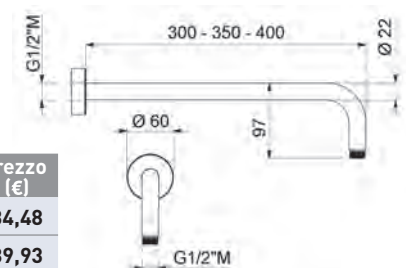

RAVENNA 50

In ottone
Ø 23 mm



●	codice	dimensioni (cm)	UM	min. ord.	conf.	cat.	prezzo (€)
●	1405007	50	NR	1	02	91,77	

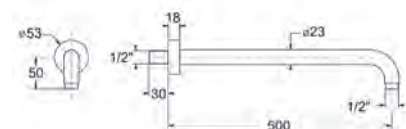

BOLOGNA

In ottone con doppio rosone (tondo e quadrato)
Ø 20 mm



●	codice	dimensioni (cm)	UM	min. ord.	conf.	cat.	prezzo (€)
●	1405024	33	NR	1	25	02	73,24

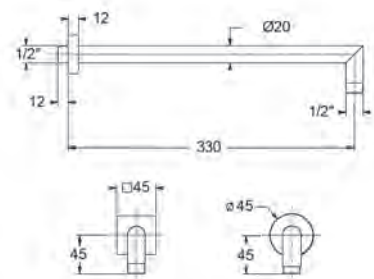

POSTUMIA QUADRATO



In ottone
L. 25x25 mm

codice	dimensioni (cm)	UM	min. ord. conf.	cat.	prezzo (€)
● 1405014	30	NR	1	02	47,04



POSTUMIA TONDO



In ottone
Ø 22 mm

codice	dimensioni (cm)	UM	min. ord. conf.	cat.	prezzo (€)
● 1405013	30	NR	1	02	35,74

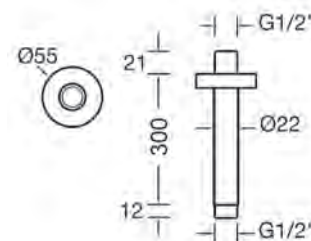

MANTOVA



In ottone
L. 25x25 mm



codice	dimensioni (cm)	finitura	UM	min. ord. conf.	cat.	prezzo (€)
● 1405017	30	cromo	NR	1	30	65,21
● 1405917	30	nero opaco	NR	1	1	129,44
● 1405817	30	simil acciaio	NR	1	1	143,11
● 1405011	35	cromo	NR	1	30	66,47
● 1405911	35	nero opaco	NR	1	1	137,63
● 1405811	35	simil acciaio	NR	1	1	150,14
● 1405018	40	cromo	NR	1	30	71,91

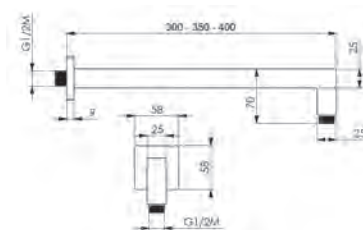

VIENNA



In ottone
L. 35x15 mm

codice	dimensioni (cm)	UM	min. ord. conf.	cat.	prezzo (€)
● 1405038	40	NR	1	02	83,95

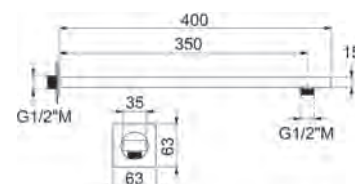

PRAGA



In ottone
Ø 25 mm



codice	dimensioni (cm)	finitura	UM	min. ord. conf.	cat.	prezzo (€)
● 1405037	40	cromo	NR	1	02	59,26
● 1405937	40	nero opaco	NR	1	02	86,05

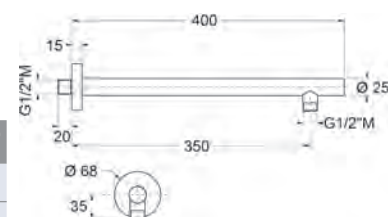

LINEA DOCCIA

DOCCETTE

ENERGY



In ABS cromato 5 getti con cascata e leva regolatore di flusso, anticalcare
Portata litri/minuto: **7,1**

codice	Ø (mm)	UM	min. ord. conf.	cat.	prezzo (€)
● 1410002	155	NR	1	06	47,74

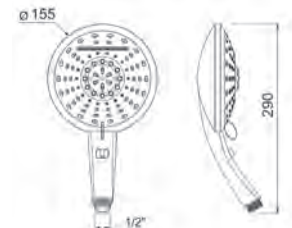

VITTORIA



In ABS cromato 5 getti anticalcare
Portata litri/minuto: **9**

codice	Ø (mm)	UM	min. ord. conf.	cat.	prezzo (€)
● 1410023	120	NR	1	06	30,42



MARINE



In ABS cromato 5 getti anticalcare
Portata litri/minuto: **10,4**

codice	Ø (mm)	UM	min. ord. conf.	cat.	prezzo (€)
● 1410003	90	NR	1	06	15,98

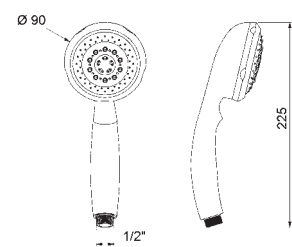

DIANA



In ABS cromo/grigio 5 getti anticalcare
Portata litri/minuto: **15,9**

codice	Ø (mm)	UM	min. ord. conf.	cat.	prezzo (€)
● 1410034	112	NR	1	06	13,86



LINDA



In ABS cromato 3 getti anticalcare
Portata litri/minuto: **12,3**

codice	Ø (mm)	finitura	UM	min. ord. conf.	cat.	prezzo (€)
● 1410028	112	cromo	NR	1	06	28,58
1410928	112	nero opaco	NR	1	06	50,54

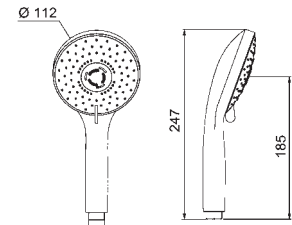

ELISA



In ABS cromato 3 getti anticalcare, con sistema risparmio acqua
Portata litri/minuto: **7,7**

codice	Ø (mm)	UM	min. ord. conf.	cat.	prezzo (€)
● 1410030	100	NR	1	06	20,59

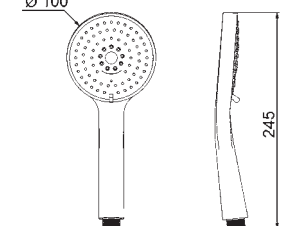

SANDY 3



In ABS cromato 3 getti anticalcare
Portata litri/minuto: **5,3**

codice	Ø (mm)	UM	min. ord. conf.	cat.	prezzo (€)
● 1410025	77	NR	1	06	13,08

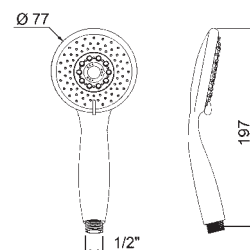

CINDY



In ABS cromato 3 getti anticalcare
Portata litri/minuto: **9,2**

codice	Ø (mm)	UM	min. ord. conf.	cat.	prezzo (€)
● 1410021	125	NR	1	06	25,27

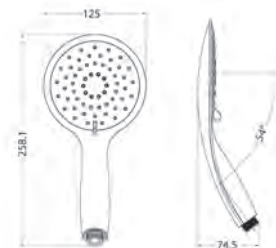

METEOR



In ABS cromato 1 getto anticalcare
Portata litri/minuto: **15,6**

codice	Ø (mm)	UM	min. ord. conf.	cat.	prezzo (€)
● 1410019	80	NR	1	06	14,29



SANDY 1



In ABS cromato 1 getto anticalcare
Portata litri/minuto: **15**

codice	Ø (mm)	UM	min. ord. conf.	cat.	prezzo (€)
● 1410024	80	NR	1	06	10,33



GROHE TEMPESTA 110 DOCCETTA

NOVITÀ!



In ABS cromato 3 getti anticalcare
Portata litri/minuto: **13,5**

codice	Ø (mm)	UM	min. ord. conf.	cat.	prezzo (€)	
● 28261003	110	NR	1	50	11	52,75



GROHE TEMPESTA 110 DOCCETTA

NOVITÀ!



In ABS cromato 2 getti anticalcare
Portata litri/minuto: **13,5**

codice	Ø (mm)	UM	min. ord. conf.	cat.	prezzo (€)	
● 27597003	110	NR	1	50	11	37,50

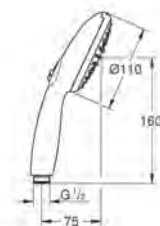

LINEA DOCCIA

DOCCETTE

DOCCETTA RETTANGOLARE OTTONE



In ottone, anticalcare
PORTATA litri/minuto: **23,2**

codice	sez. (mm)	lung. (mm)	UM	min. ord. conf.	cat.	prezzo (€)
● 1412002	35x15	229	NR	1	06	39,56



DOCCETTA TONDA OTTONE



In ottone, anticalcare
PORTATA litri/minuto: **23,2**

codice	sez. (mm)	lung. (mm)	UM	min. ord. conf.	cat.	prezzo (€)
● 1412001	Ø 24	200	NR	1	06	32,90

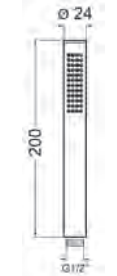

DOCCETTA A CAMPANA OTTONE



In ottone, anticalcare
PORTATA litri/minuto: **25**

codice	sez. (mm)	lung. (mm)	UM	min. ord. conf.	cat.	prezzo (€)
● 1412003	Ø 52	184	NR	1	06	25,52

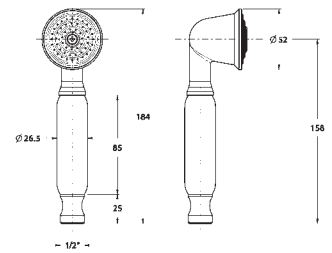

DOCCETTA QUADRATA ABS



In ABS, anticalcare
PORTATA litri/minuto: **25,8**

codice	sez. (mm)	lung. (mm)	UM	min. ord. conf.	cat.	prezzo (€)
● 1412009	28x28	230	NR	1	06	18,61

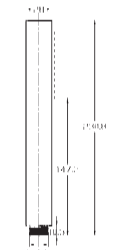

DOCCETTA TONDA ABS



In ABS, anticalcare
PORTATA litri/minuto: **17**



codice	finitura	sez. (mm)	lung. (mm)	UM	min. ord. conf.	cat.	prezzo (€)
● 1412008	cromo	Ø 32	210	NR	1	06	14,29
1412908	nero opaco	Ø 32	210	NR	1	06	51,84
1412808	simil acciaio	Ø 32	210	NR	1	06	56,16



CRYSTAL



In ABS cromato, anticalcare
PORTATA litri/minuto: **14,2**

codice	sez. (mm)	lung. (mm)	UM	min. ord. conf.	cat.	prezzo (€)
● 1410036	43x19	225	NR	1	06	20,52

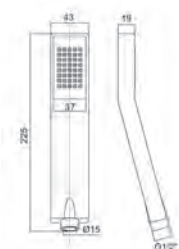

QUADRA OTTONE CON PRESA ACQUA

Set composto da: doccetta rettangolare in ottone, presa acqua centrale quadrata, flessibile 150 cm.

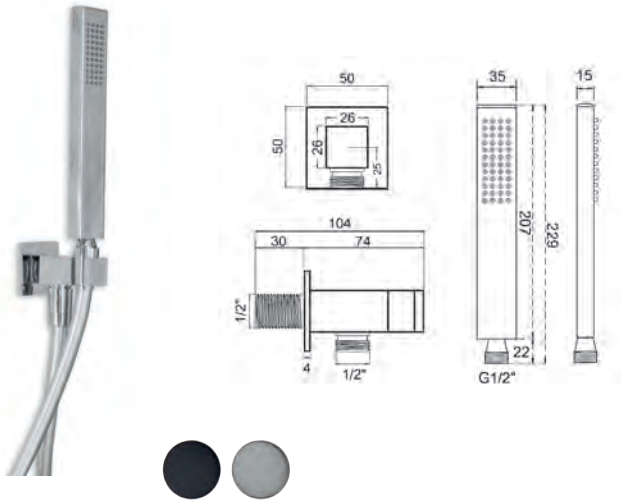

TONDA OTTONE CON PRESA ACQUA

Set composto da: doccetta tonda in ottone, presa acqua centrale tonda, flessibile 150 cm.

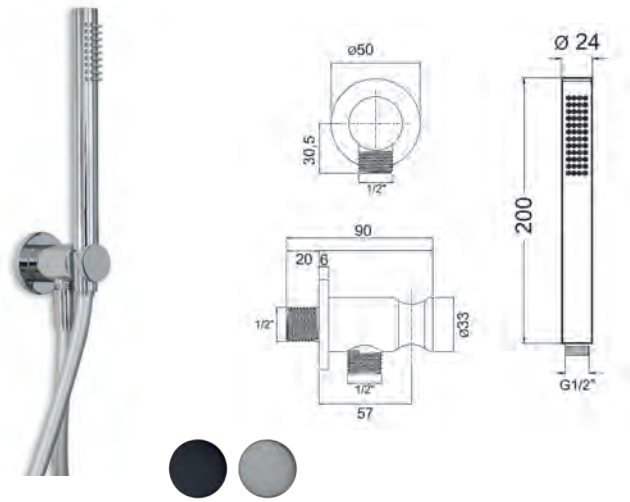

SET DOCCIA	1409010	1409910	1409810
Componenti:	cromo	nero	simil acciaio
doccetta	1412002		
presa acqua	1409007		
flessibile silver	1407003		
flessibile doppia agg.		1406903	1406803

SET DOCCIA	1409012	1409912	1409812
Componenti:	cromo	nero	simil acciaio
doccetta	1412001		
presa acqua	1409008	1409908	1409808
flessibile silver	1407003		
flessibile doppia agg.		1406903	1406803

codice	finitura	UM	min. ord.	conf.	cat.	prezzo (€)
● 1409010	cromo	NR	1	20	02	84,05
● 1409910	nero opaco	NR	1	20	02	160,07
● 1409810	simil acciaio	NR	1	20	02	180,54

codice	finitura	UM	min. ord.	conf.	cat.	prezzo (€)
● 1409012	cromo	NR	1	20	02	79,63
● 1409912	nero opaco	NR	1	20	02	164,29
● 1409812	simil acciaio	NR	1	20	02	144,43

QUADRA OTTONE CON PRESA ACQUA

Set composto da: doccetta rettangolare in ottone (1412002), presa d'acqua centrale quadrata (1409007), **flessibile doppia aggraffatura 150 cm.** (1406003)

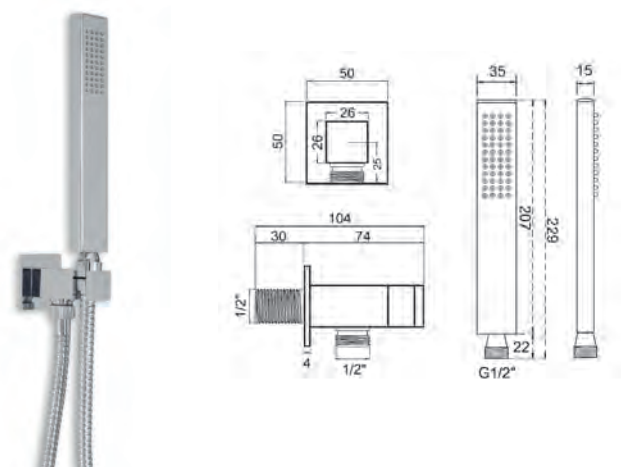

TONDA OTTONE CON PRESA ACQUA

Set composto da: doccetta tonda in ottone (1412001), presa d'acqua centrale tonda (1409008), **flessibile doppia aggraffatura 150 cm.** (1406003)

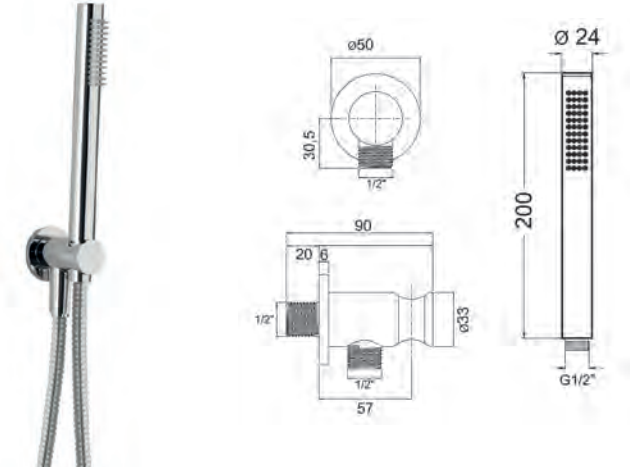

codice	UM	min. ord.	conf.	cat.	prezzo (€)
● 1409021	NR	1	20	02	79,63

codice	UM	min. ord.	conf.	cat.	prezzo (€)
● 1409022	NR	1	20	02	75,24

LINEA DOCCIA

SET DOCCIA

LINEA DOCCIA

TONDA ABS CON PRESA ACQUA

Set composto da: doccetta tonda in ABS (1412008), presa d'acqua centrale tonda (1409008), **flessibile silver 150 cm.** (1407003)

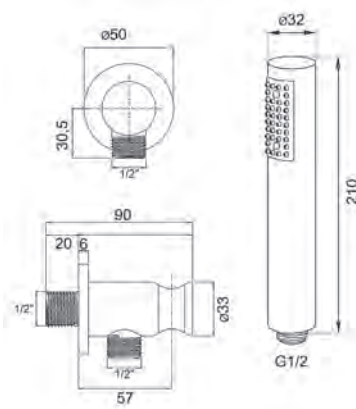

codice	UM	min. ord.	conf.	cat.	prezzo (€)
● 1409013	NR	1	20	02	61,95

QUADRA ABS CON PRESA ACQUA

Set composto da: doccetta quadrata in ABS (1412009), presa d'acqua centrale quadrata (1409007), **flessibile silver 150 cm.** (1407003)

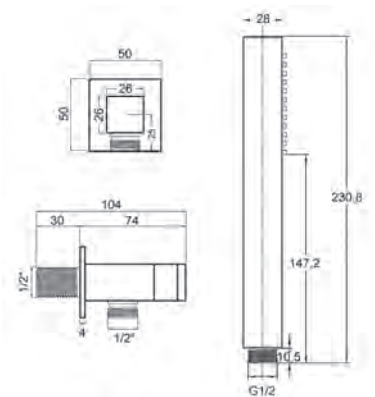

codice	UM	min. ord.	conf.	cat.	prezzo (€)
● 1409011	NR	1	20	02	66,37

PRESE ACQUA

TONDA CON DUPLEX

In ottone, orientabile.

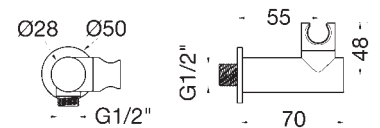

codice	attacchi	UM	min. ord.	conf.	cat.	prezzo (€)
● 1409005	1/2" M x 1/2" M	NR	1	50	02	55,17

QUADRA DUPLEX

In ottone, orientabile.

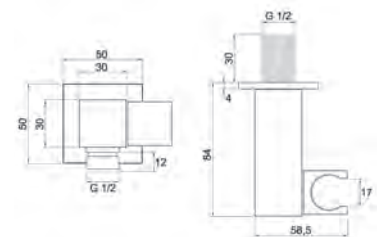

codice	attacchi	UM	min. ord.	conf.	cat.	prezzo (€)
● 1409004	1/2" M x 1/2" M	NR	1	20	02	63,48

TONDA CENTRALE

In ottone, attacchi 1/2" maschio.

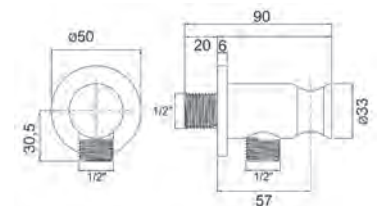

codice	finitura	UM	min. ord.	conf.	cat.	prezzo (€)
● 1409008	cromo	NR	1	44	02	39,61
1409908	nero opaco	NR	1	1	02	65,28
1409808	simill acciaio	NR	1	1	02	68,54

QUADRATA CENTRALE

In ottone



codice	attacchi	UM	min. ord.	conf.	cat.	prezzo (€)
● 1409007	1/2" M x 1/2" M	NR	1	44	02	39,61

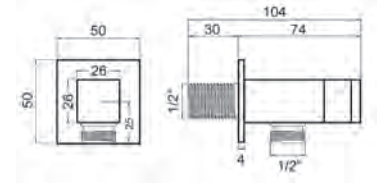

TONDA STICK CON RUBINETTO CHIUSURA

In ottone



codice	attacchi	UM	min. ord.	conf.	cat.	prezzo (€)
● 1409024	1/2" M x 1/2" M	NR	1	02	02	39,70

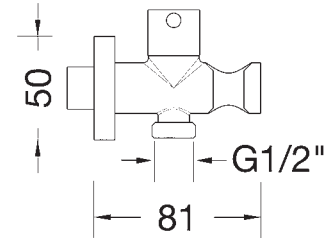

TONDA CON RUBINETTO CHIUSURA

In ottone



codice	attacchi	UM	min. ord.	conf.	cat.	prezzo (€)
● 1409025	1/2" M x 1/2" M	NR	1	02	02	46,11

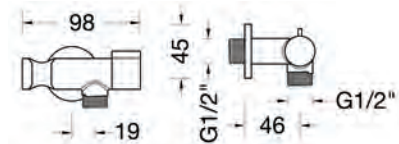

POSTUMIA TONDA

In ottone



codice	attacchi	UM	min. ord.	conf.	cat.	prezzo (€)
● 1409014	1/2" M x 1/2" M	NR	1	50	02	31,62

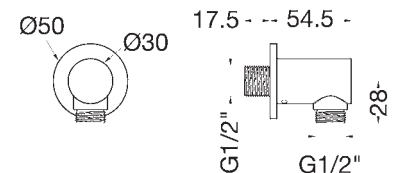

POSTUMIA QUADRATA

In ottone



codice	attacchi	UM	min. ord.	conf.	cat.	prezzo (€)
● 1409002	1/2" M x 1/2" M	NR	1	50	02	31,99

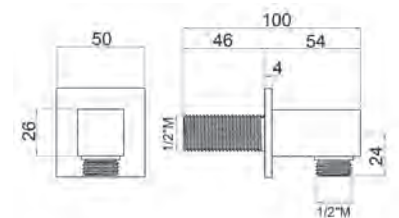

CLASSIC

In ottone



codice	attacchi	UM	min. ord.	conf.	cat.	prezzo (€)
● 1412016	1/2" M x 1/2" M	NR	1	1	02	44,54

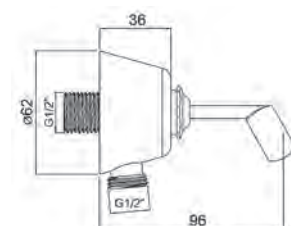

LINEA DOCCIA

PRESE ACQUA

PRESA ACQUA TONDA

In ottone.



	codice	∅	H (mm)	finitura	UM	min. ord.	conf.	cat.	prezzo (€)
●	1409009	50	26	cromo	NR	1	100	02	11,90
●	1409909	50	26	nero opaco	NR	1	1	02	49,30
	1409809	50	26	simil acciaio	NR	1	1	02	33,46

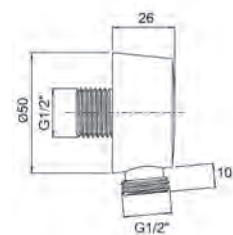

PRESA ACQUA ROSONE

In ottone



	codice	∅	UM	min. ord.	conf.	cat.	prezzo (€)
●	2731121	70	NR	1	50	06	11,02
●	2731104	56	NR	1	100	06	6,52

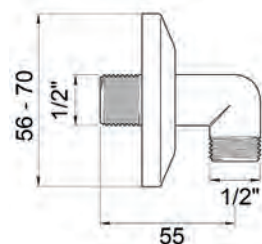

SUPPORTI DOCCIA

SUPPORTO DUPLEX QUADRATO

In ottone, orientabile.



	codice	UM	min. ord.	conf.	cat.	prezzo (€)
●	1412004	NR	1	50	02	48,82

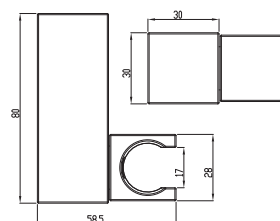

SUPPORTO DUPLEX OVALE

In ottone, fisso.



	codice	UM	min. ord.	conf.	cat.	prezzo (€)
●	1412014	NR	1	1	02	42,50

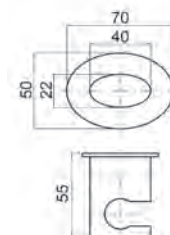

SUPPORTO DUPLEX CLASSIC

In ottone, orientabile.



	codice	UM	min. ord.	conf.	cat.	prezzo (€)
●	1412015	NR	1	1	02	34,99

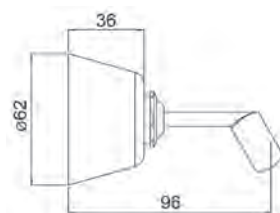

LINEA DOCCIA

IDROSCOPINI E KIT DOCCETTA

LINEA DOCCIA

SPRAY 1



Kit doccetta in ABS composto da doccetta (1401019), flessibile antitorsione da 120 cm., supporto cromato.

codice	UM	min. ord. conf.	cat.	prezzo (€)
● 1401010	NR	1	02	37,26

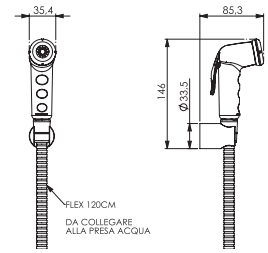

SPRAY 4



Kit doccetta in ABS composto da doccetta bianca (1401024), flessibile bianco da 120 cm., supporto bianco.

codice	UM	min. ord. conf.	cat.	prezzo (€)
● 1401027	NR	1	02	21,52

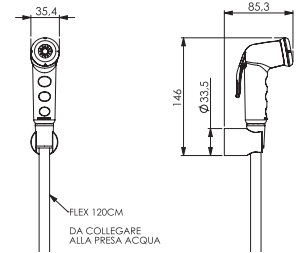

SPRAYJET 0

NOVITÀ!



Kit in ottone composto da doccetta in ottone con doppia funzione "idroscoopino e doccetta" (1401037), flessibile doppia aggaffatura da 120 cm. (1406011), supporto cromato, senza rubinetto.

codice	UM	min. ord. conf.	cat.	prezzo (€)
● 1401036	NR	1	02	51,85

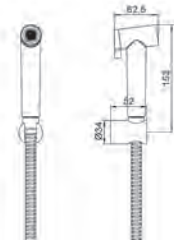

SPRAY 5

NOVITÀ!



Kit in ottone composto da doccetta in ottone con doppia funzione "idroscoopino e doccetta" (1401037), flessibile doppia aggaffatura da 120 cm. (1406011), con miscelatore esterno. Per prevenire il rischio di rottura del flessibile, si raccomanda di chiudere sempre il rubinetto dopo l'uso.

codice	UM	min. ord. conf.	cat.	prezzo (€)
● 1401033	NR	1	02	142,46

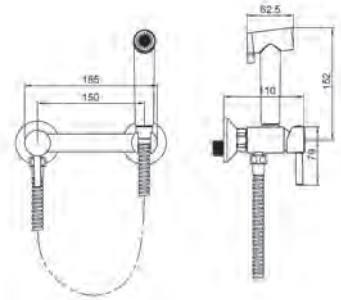

SPRAY 6

NOVITÀ!



Kit in ottone composto da doccetta in ottone con doppia funzione "idroscoopino e doccetta" (1401037), flessibile doppia aggaffatura da 120 cm. (1406011), con miscelatore ad incasso. Per prevenire il rischio di rottura del flessibile, si raccomanda di chiudere sempre il rubinetto dopo l'uso.



codice	finitura	UM	min. ord. conf.	cat.	prezzo (€)
● 1401034	cromo	NR	1	02	144,84
1401934	nero opaco	NR	1	02	306,31
1401834	simil acciaio	NR	1	02	299,57

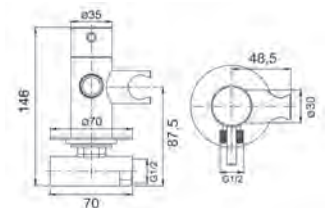

ACCESSORI IDROSCOPINI E KIT DOCCETTA

DOCCETTA LASER OTTONE SPRAYJET 2



codice	UM	min. ord. conf.	cat.	prezzo (€)
● 1401022	NR	1	02	37,03

DOCCETTA OTTONE SPRAY



codice	UM	min. ord. conf.	cat.	prezzo (€)
● 1401014	NR	1	02	43,76

DOCCETTA ABS SPRAY 1 E SPRAYJET 5



codice	UM	min. ord. conf.	cat.	prezzo (€)
● 1401019	NR	1	02	13,97

DOCCETTA ABS SPRAY C/FERMO LEVA



codice	UM	min. ord. conf.	cat.	prezzo (€)
● 1401013	NR	1	02	10,10

DOCCETTA ABS SPRAY 4



codice	UM	min. ord. conf.	cat.	prezzo (€)
● 1401024	NR	1	02	6,97

RUBINETTO STICK C/CHIUSURA PER IDROSCOPINO

Rubinetto per:
Sprayjet 1 (1401009)
Sprayjet 5 (1401011)



codice	UM	min. ord. conf.	cat.	prezzo (€)
● 1401012	NR	1	06	22,25

DOCCETTA OTTONE 2 GETTI

Con doppia funzione
(idroscopino e doccetta) per:
Sprayjet 0 (1401036)
Spray 5 (1401033)
Spray 6 (1401034)

NOVITÀ!



codice	UM	min. ord. conf.	cat.	prezzo (€)
● 1401037	NR	1	02	37,84

LINEA DOCCIA

FLESSIBILI DOCCIA

SILVER LUX CONICO F/F

In PVC metallizzato, antitorsione.



codice	lunghezza (cm)	misura	UM	min. ord. conf.	cat.	prezzo (€)
● 1407012	150	1/2"x1/2"	NR	1	09	25,76
● 1407013	200	1/2"x1/2"	NR	1	09	30,04

SILVER CONICO F/F

In PVC, antitorsione.



codice	lunghezza (cm)	misura	UM	min. ord. conf.	cat.	prezzo (€)
● 1407003	150	1/2"x1/2"	NR	1	09	13,24
● 1407006	200	1/2"x1/2"	NR	1	09	18,76

NERO OPACO CONICO F/F

In PVC, antitorsione.



codice	lunghezza (cm)	misura	UM	min. ord. conf.	cat.	prezzo (€)
● 1407903	150	1/2"x1/2"	NR	1	09	16,32

GROHE RELEXAFLEX

In PVC cromo, antitorsione.



codice	lunghezza (cm)	misura	UM	min. ord. conf.	cat.	prezzo (€)
● 28151002	150	1/2"x1/2"	NR	1	11	24,97

DOPPIA AGGRAFFATURA F/F

In acciaio inox.

Attacchi femmina 1/2"x1/2"



codice	lunghezza (cm)	finitura	UM	min. ord.	conf.	cat.	prezzo (€)
● 1406015	60	cromo	NR	1	100	09	8,84
● 1406915	60	nero opaco	NR	1	1	09	30,00
● 1406815	60	simil acciaio	NR	1	1	15	27,75
● 1406011	120	cromo	NR	1	36	09	9,96
● 1406003	150	cromo	NR	1	36	09	10,80
● 1406903	150	nero opaco	NR	1	50	15	38,85
● 1406803	150	simil acciaio	NR	1	50	15	53,43
● 1406004	200	cromo	NR	1	36	09	11,92

DOPPIA AGGRAFFATURA PESANTE F/F

In acciaio antitorsione.



codice	lunghezza (cm)	misura	UM	min. ord. conf.	cat.	prezzo (€)
● 1406023	150	1/2"x1/2"	NR	1	09	14,36
● 1406024	200	1/2"x1/2"	NR	1	09	17,16

ACCIAIO CONICO F/F

In spirale di acciaio, antitorsione.



NOVITÀ!

codice	lunghezza (cm)	misura	UM	min. ord. conf.	cat.	prezzo (€)
● 1406016	150	1/2"x1/2"	NR	1	09	36,40
● 1406017	200	1/2"x1/2"	NR	1	09	55,44

ACCIAIO RIVESTITO PVC TRASPARENTE

Per alte pressioni, DN8
temperatura Max 70°C
Pressione d'esercizio 10 bar



codice	lunghezza (cm)	misura	UM	min. ord. conf.	cat.	prezzo (€)
● 1407014	120	1/2"x1/2"	NR	1	09	20,28

KIT RIDUTTORE PORTATA 5-7-11 LITRI

Confezione 4 pz.



5 lt/min 7 lt/min 11 lt/min Guarn. 1/2"

codice	UM	min. ord. conf.	cat.	prezzo (€)
● 1401021	NR	1	23	2,58

RICAMBI

CURSORE UNIVERSALE

In ABS. Per asta D.18/25 mm.
Si installa senza dover smontare l'asta.



codice	UM	min. ord. conf.	cat.	prezzo (€)
● 1411007	NR	1	02	13,50

CURSORE UNIVERSALE NERO OPACO

In ABS. Per asta D.18/25 mm.
Si installa senza dover smontare l'asta.



codice	UM	min. ord. conf.	cat.	prezzo (€)
● 1411907	NR	1	02	23,09

CURSORE PER SALISCENDI

In ABS. Per asta D.25,4 mm.



codice	UM	min. ord. conf.	cat.	prezzo (€)
● 1411003	NR	1	02	8,13

CURSORE PER SALISCENDI KELLY

In ABS. Per asta D.25 mm.

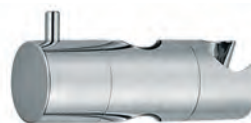

codice	UM	min. ord. conf.	cat.	prezzo (€)
● 1411004	NR	1	02	11,15

LINEA DOCCIA

RICAMBI

PORTASAPONE UNIVERSALE TRASPARENTE

Per asta D.18/21/22/25 mm.



codice	UM	min. ord. conf.	cat.	prezzo (€)
● 1404011	NR	1	02	19,18

ATTACCO MISCELATORE CON DEVIATORE

Attacco miscelatore 1/2F"



RICAMBI (PAG. 64)
1406030 - Cartuccia

codice	attacco colonna	finitura	UM	min. ord. conf.	cat.	prezzo (€)
● 1414009	1/2"M	cromo	NR	1	02	43,23
1414909	1/2"M	nero opaco	NR	1	02	60,51
1414809	1/2"M	simil acciaio	NR	1	02	60,51

SUPPORTO INFERIORE COLONNA DOCCIA

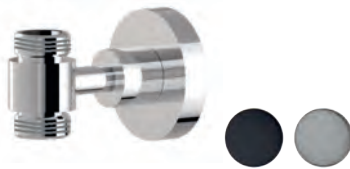

codice	attacco colonna	finitura	UM	min. ord. conf.	cat.	prezzo (€)
● 1414012	1/2"M	cromo	NR	1	02	55,76
1414912	1/2"M	nero opaco	NR	1	02	78,05
1414812	1/2"M	simil acciaio	NR	1	02	78,05

ATTACCO SUPERIORE COLONNA DOCCIA



codice	UM	min. ord. conf.	cat.	prezzo (€)
● 1414016	NR	1	02	32,39

SUPPORTO REGOLABILE ORIZZONTALE/VERTICALE

Ideale per le sostituzioni, permette di fissare la colonna D.24 mm. riutilizzando i fori precedenti

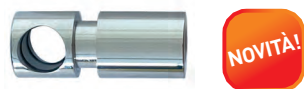

codice	regolazione	UM	min. ord. conf.	cat.	prezzo (€)
● 1414017	0 - 3 cm	NR	1	04	42,97

SOFFIONE SUPERIORE

NOVITÀ!



Compatibilità:

- 1350903 - Colonna multifunzione SELENE
- 1350907 - Colonna multifunzione FLORA
- 1350912 - Colonna multifunzione SELENE
- 1350913 - Colonna multifunzione AURORA
- 1350917 - Colonna multifunzione DIANA

codice	dimensioni (mm)	UM	min. ord. conf.	cat.	prezzo (€)
● 1350996	232x140	NR	1	05	44,10

SOFFIONE FRONTALE

NOVITÀ!



Compatibilità:

- 1350902 - Colonna multifunzione IRIDE
- 1350907 - Colonna multifunzione FLORA
- 1350913 - Colonna multifunzione AURORA
- 1350917 - Colonna multifunzione DIANA

codice	dimensioni (mm)	UM	min. ord. conf.	cat.	prezzo (€)
● 1350999	98x98	NR	1	05	29,41

SOFFIONE SUPERIORE

NOVITÀ!



Compatibilità:

- 1350902 - Colonna multifunzione IRIDE
- 1350908 - Colonna multifunzione ATENA

codice	dimensioni (mm)	UM	min. ord. conf.	cat.	prezzo (€)
● 1350998	204x108	NR	1	05	44,10

SOFFIONE FRONTALE

NOVITÀ!

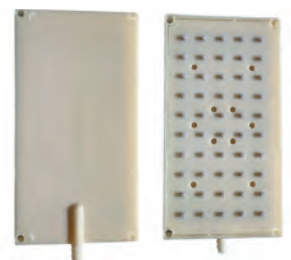

Compatibilità:

- 1350903 - Colonna multifunzione SELENE
- 1350908 - Colonna multifunzione ATENA
- 1350912 - Colonna multifunzione SELENE

codice	dimensioni (mm)	UM	min. ord. conf.	cat.	prezzo (€)
● 1350993	204 x 108	NR	1	05	44,10

LINEA DOCCIA

CATALOGO
LISTINO N° 8

SANITARI

SANITARI

CERAMICA SANITARIA	128
PIATTI DOCCIA	139
AUSILI BAGNO DISABILI	152
SEDILI	165
CASSETTE DI SCARICO	166
LAVATOI	174

CERAMICA SANITARIA

SERIE 4ALL

LAVABO

Installazione sospesa, completo di fissaggi.



codice	sigla	dimensioni (cm)	UM	min. ord.	pz. pallet	cat.	prezzo (€)
3702370	MDO70BI	70x48	NR	1	12	04	377,43

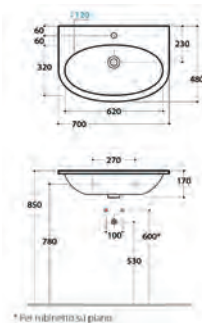

* Per rubinetto sul piano

SANITARI

WC SOSPESO SENZA BRIDA

Completo di fissaggi.



3702382 - 3702383 - Sedile bianco lucido
3703383 - Sedile bianco opaco

codice	sigla	finitura	dimensioni (cm)	UM	min. ord.	pz. pallet	cat.	prezzo (€)
3702371	MDS03BI	bianco lucido	54x36	NR	1	15	04	437,88
3703371	MDS03BO	bianco opaco	54x36	NR	1	15	04	656,83

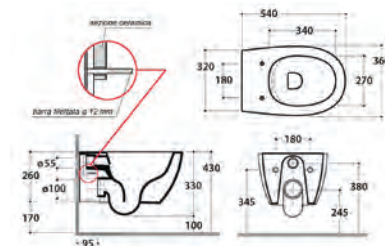

BIDET SOSPESO

Completo di fissaggi.



codice	sigla	finitura	dimensioni (cm)	UM	min. ord.	pz. pallet	cat.	prezzo (€)
3702372	MDS09BI	bianco lucido	54x36	NR	1	15	04	406,60
3703372	MDS09BO	bianco opaco	54x36	NR	1	15	04	609,93

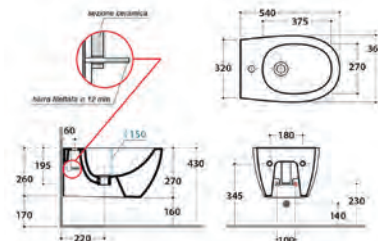

WC SOSPESO SENZA BRIDA

Completo di fissaggi.



3702384 - 3702385 - Sedile bianco lucido
3703385 - Sedile bianco opaco

codice	sigla	finitura	dimensioni (cm)	UM	min. ord.	pz. pallet	cat.	prezzo (€)
3702373	MDS04BI	bianco lucido	48x37	NR	1	15	04	406,60
3703373	MDS04BO	bianco opaco	48x37	NR	1	15	04	609,93

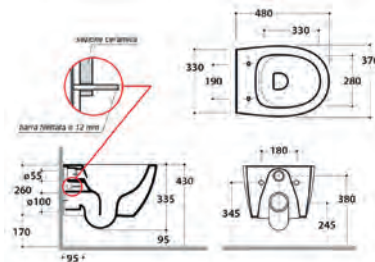

BIDET SOSPEO

Completo di fissaggi.

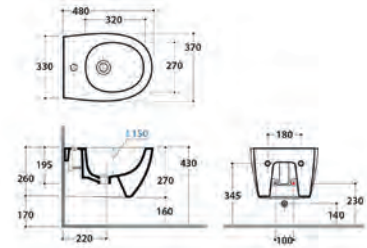

codice	sigla	finitura	dimensioni (cm)	UM	min. ord.	pz. pallet	cat.	prezzo (€)
3702374	MDS10BI	bianco lucido	48x37	NR	1	15	04	406,60
3703374	MDS10BO	bianco opaco	48x37	NR	1	15	04	609,93

WC MULTI 2.0

Vaso a terra con scarico multi regolabile(*), installazione filo parete. Completo di fissaggi.



(*) Possibili quote scarico in base alla curva tecnica

codice	sigla	tipo scarico	regolazione
3702345	VA092	pavimento	da 7 a 9 cm
3702346	VA093	pavimento	da 10 a 13 cm
3702345 + 3702349	VA092 + VA026	pavimento	da 14 a 31 cm
3702390	VA027	parete	da 21 a 25 cm

Possibili quote entrata acqua in base al raccordo

codice	sigla	regolazione (cm)
3702348	VA086	35,5 / 36 / 37 / 37,5
3702391	VA028	34,5 / 35 / 38 / 38,5

Sedile:

3702382 - 3702383

codice	sigla	dimensioni (cm)	UM	min. ord.	pz. pallet	cat.	prezzo (€)
3702377	MD005BI	54x36	NR	1	15	04	469,15



WC MULTI SENZA BRIDA

Vaso a terra con scarico multi regolabile(*), installazione filo parete. Completo di fissaggi.



(*) Possibili quote scarico in base alla curva tecnica

codice	sigla	tipo scarico	regolazione
3702345	VA092	pavimento	da 6 a 11 cm
3702346	VA093	pavimento	da 12 a 15 cm
3702347	VA094	pavimento	da 16 a 20 cm

Possibili quote entrata acqua in base al raccordo

codice	sigla	regolazione (cm)
3702348	VA086	33 / 36

3702382 - 3702383 - Sedile bianco lucido

3703383 - Sedile bianco opaco

codice	sigla	finitura	dimensioni (cm)	UM	min. ord.	pz. pallet	cat.	prezzo (€)
3702378	MD004BI	bianco lucido	54x36	NR	1	15	04	469,15
3703378	MD004BO	bianco opaco	54x36	NR	1	15	04	703,76



BIDET MULTI 2.0

Installazione filo parete, completo di fissaggi.

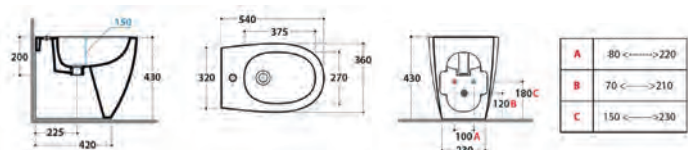

codice	sigla	finitura	dimensioni (cm)	UM	min. ord.	pz. pallet	cat.	prezzo (€)
3702379	MD011BI	bianco lucido	54x36	NR	1	15	04	469,15
3703379	MD011BO	bianco opaco	54x36	NR	1	15	04	703,76

CERAMICA SANITARIA

SERIE 4ALL

WC/BIDET SOSPEO

Completo di fissaggi.



Sedile:
3702382 - 3702383

codice	sigla	dimensioni (cm)	UM	min. ord.	pz. pallet	cat.	prezzo (€)
3702380	MDB02BI	54x36	NR	1	15	04	469,15

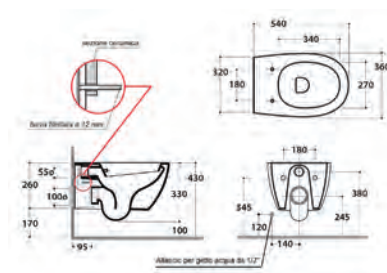

WC/BIDET MULTI

Vaso/bidet a terra con scarico multi regolabile, installazione filo parete. Completo di fissaggi.



Sedile:
3702382 - 3702383

codice	sigla	dimensioni (cm)	UM	min. ord.	pz. pallet	cat.	prezzo (€)
3702381	MDB01BI	54x36	NR	1	15	04	469,15

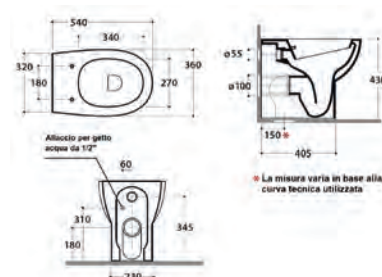

SEDILE TERMOINDURENTE

Rimovibile con sgancio rapido.



Per WC bianco lucido:
3702371 - 3702377 - 3702378 - 3702380 - 3702381
Per WC bianco opaco:
3703371 - 3703378

codice	sigla	finitura	chiusura	UM	min. ord.	pz. pallet	cat.	prezzo (€)
3702382	MDR19BI	bianco lucido	tradizionale	NR	1	75	04	106,45
3702383	MDR20BI	bianco lucido	rallentata	NR	1	75	04	163,53
3703383	MDR20BO	bianco opaco	rallentata	NR	1	75	04	294,13

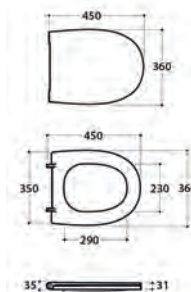

SEDILE TERMOINDURENTE

Rimovibile con sgancio rapido.



Per WC bianco lucido:
3702373
Per WC bianco opaco:
3703373

codice	sigla	finitura	chiusura	UM	min. ord.	pz. pallet	cat.	prezzo (€)
3702385	MD022BI	bianco lucido	rallentata	NR	1	75	04	163,53
3703385	MD022BO	bianco opaco	rallentata	NR	1	75	04	294,13

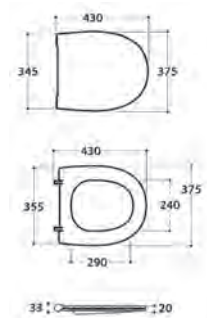

LAVABO



Installazione sospesa.
Completo di fissaggi.

codice	sigla	AxBxCxD (cm)	UM	min. ord.	pz. pallet	cat.	prezzo (€)
3702350	ME100BI	100x49x50,5x27	NR	1	10	04	550,65
3702351	ME080BI	80x49x44,5x20	NR	1	12	04	477,52

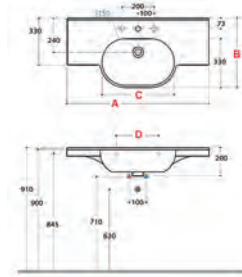

LAVABO SOSPESO SINISTRO



Installazione sospesa.
Completo di fissaggi.

codice	sigla	dimensioni (cm)	UM	min. ord.	pz. pallet	cat.	prezzo (€)
3702352	ME070SBI	70x45	NR	1	12	04	376,43

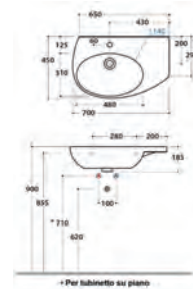

LAVABO SOSPESO DESTRO



Installazione sospesa.
Completo di fissaggi.

codice	sigla	dimensioni (cm)	UM	min. ord.	pz. pallet	cat.	prezzo (€)
3702353	ME070DBI	70x45	NR	1	12	04	376,43

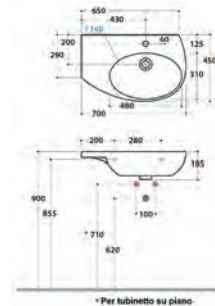

WC SOSPESO SENZA BRIDA



Completo di fissaggi.

3702359 - 3702360 - Sedile bianco lucido
3703360 - Sedile bianco opaco

codice	sigla	finitura	dimensioni (cm)	UM	min. ord.	pz. pallet	cat.	prezzo (€)
3702354	MES02BI	bianco lucido	53x34	NR	1	15	04	354,92
3703354	MES02BO	bianco opaco	53x34	NR	1	15	04	532,39

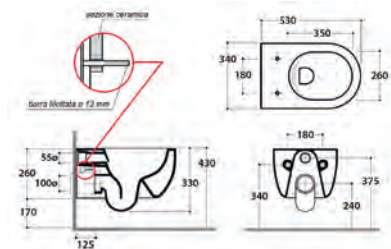

BIDET SOSPESO



Completo di fissaggi.

codice	sigla	finitura	dimensioni (cm)	UM	min. ord.	pz. pallet	cat.	prezzo (€)
3702355	MES09BI	bianco lucido	53x34	NR	1	15	04	354,92
3703355	MES09BO	bianco opaco	53x34	NR	1	15	04	532,39

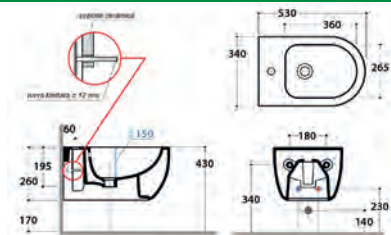

CERAMICA SANITARIA

SERIE MODE

WC SOSPESO SENZA BRIDA

Completo di fissaggi.



Sedile:
3702361

codice	sigla	dimensioni (cm)	UM	min. ord.	pz. pallet	cat.	prezzo (€)
3702356	MES03BI	46x34	NR	1	15	04	354,92

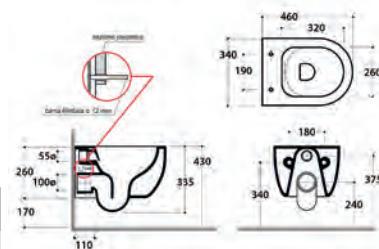

WC MULTI SENZA BRIDA

Vaso a terra con scarico multi regolabile (*), installazione filo parete. Completo di fissaggi.



(*) Possibili quote scarico in base alla curva tecnica

codice	sigla	tipo scarico	regolazione
3702345	VA092	pavimento	da 6 a 12 cm
3702346	VA093	pavimento	da 13 a 15 cm
3702347	VA094	pavimento	da 16 a 21 cm

Sedile bianco lucido:
3702359 - 3702360
Sedile bianco opaco:
3703360

Possibili quote entrata acqua in base al raccordo

codice	sigla	regolazione (cm)
3702348	VA086	33 / 36

codice	sigla	finitura	dimensioni (cm)	UM	min. ord.	pz. pallet	cat.	prezzo (€)
3702357	ME001BI	bianco lucido	53x34	NR	1	15	04	349,56
3703357	ME001BO	bianco opaco	53x34	NR	1	15	04	524,86

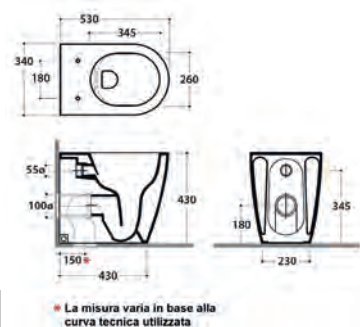

* La misura varia in base alla curva tecnica utilizzata

BIDET MULTI

Installazione filo parete, completo di fissaggi.



codice	sigla	finitura	dimensioni (cm)	UM	min. ord.	pz. pallet	cat.	prezzo (€)
3702358	ME009BI	bianco lucido	53x34	NR	1	15	04	349,56
3703358	ME009BO	bianco opaco	53x34	NR	1	15	04	524,86

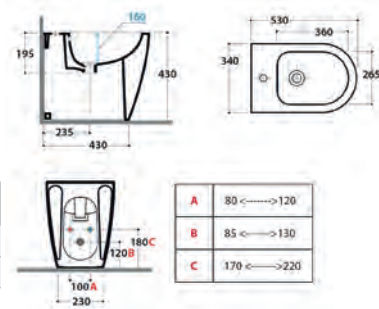

	A	B	C
80	120	130	220

SEDILE TERMOINDURENTE

Rimovibile con sgancio rapido.



Per WC bianco lucido:
3702354 - 3702357
Per WC bianco opaco:
37033547 - 3703357

codice	sigla	finitura	chiusura	UM	min. ord.	pz. pallet	cat.	prezzo (€)
3702359	ME019BI	bianco lucido	tradizionale	NR	1	75	04	111,35
3702360	ME020BI	bianco lucido	rallentata	NR	1	75	04	171,03
3703360	ME020BO	bianco opaco	rallentata	NR	1	75	04	307,64

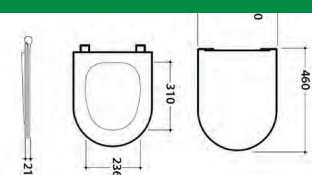

SEDILE TERMOINDURENTE

Rimovibile con sgancio rapido.



Per WC:
3702356

codice	sigla	chiusura	UM	min. ord.	pz. pallet	cat.	prezzo (€)
3702361	ME021BI	tradizionale	NR	1	90	04	171,03

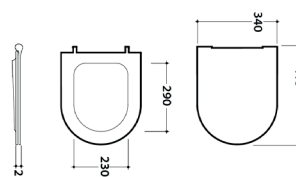

LAVABO MONOFORO

Installazione sospesa, su colonna o semicolonna.

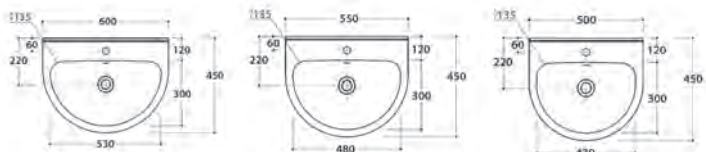

codice	sigla	dimensioni (cm)	UM	min. ord.	pz. pallet	cat.	prezzo (€)
3702332	GRN60BI	60x45	NR	1	18	04	141,73
3702341	GRN55BI	55x45	NR	1	20	04	137,95
3702342	GRN50BI	50x45	NR	1	24	04	134,17

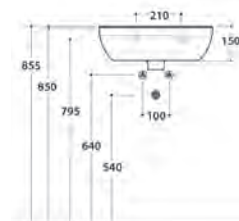

COLONNA

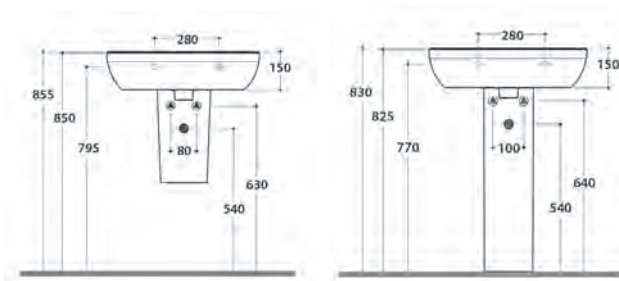

codice	sigla	descrizione	UM	min. ord.	pz. pallet	cat.	prezzo (€)
3702344	GRN05BI	Colonna	NR	1	16	04	120,00
3702343	GRSN5BI	Semicolonna	NR	1	30	04	120,00

LAVABO SOSPESO

Installazione sospesa.

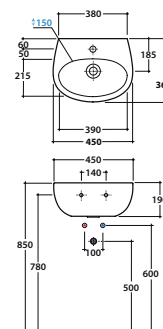

codice	sigla	dimensioni (cm)	UM	min. ord.	pz. pallet	cat.	prezzo (€)
3702305	GR045BI	45x36	NR	1	24	04	130,39

CERAMICA SANITARIA

SERIE GRACE

WC SOSPESO SENZA BRIDA

Completo di fissaggi.



Sedile:
3702321 - 3702334

codice	sigla	dimensioni (cm)	UM	min. ord.	pz. pallet	cat.	prezzo (€)
3702336	GRS03BI	52x36	NR	1	18	04	264,55

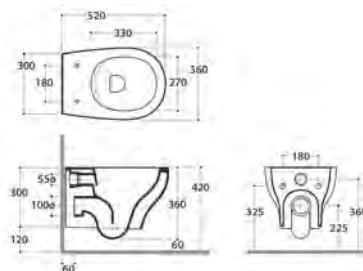

BIDET SOSPESO

Completo di fissaggi.



codice	sigla	dimensioni (cm)	UM	min. ord.	pz. pallet	cat.	prezzo (€)
3702337	GRS10BI	52x36	NR	1	18	04	264,55

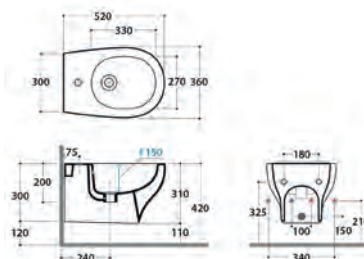

WC MULTI SENZA BRIDA

Vaso a terra con scarico multi regolabile (*), installazione filo parete. Completo di fissaggi.



(* Possibili quote scarico in base alla curva tecnica

codice	sigla	tipo scarico	regolazione
3702345	VA092	pavimento	da 6 a 12 cm
3702346	VA093	pavimento	da 13 a 15 cm
3702347	VA094	pavimento	da 16 a 20 cm

Possibili quote entrata acqua in base al raccordo

codice	sigla	regolazione (cm)
3702348	VA086	33 / 36

Sedile:
3702321 - 3702334

codice	sigla	dimensioni (cm)	UM	min. ord.	pz. pallet	cat.	prezzo (€)
3702338	GR003BI	52x36	NR	1	18	04	259,81

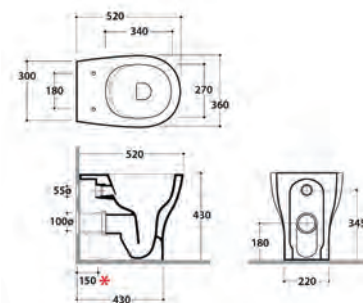

BIDET MULTI

Installazione filo parete. Completo di fissaggi.



codice	sigla	dimensioni (cm)	UM	min. ord.	pz. pallet	cat.	prezzo (€)
3702339	GR012BI	52x36	NR	1	18	04	259,81

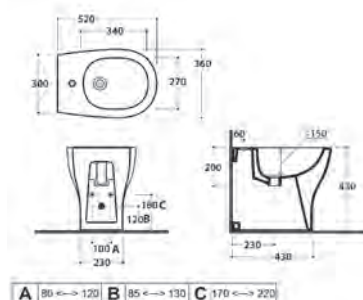

SEDILE TERMOINDURENTE

Removibile con sgancio rapido



Per WC:
3702338

codice	sigla	chiusura	UM	min. ord.	pz. pallet	cat.	prezzo (€)
3702321	GR021BI	tradizionale	NR	1	90	04	99,88
3702334	GR022BI	rallentata	NR	1	90	04	160,70

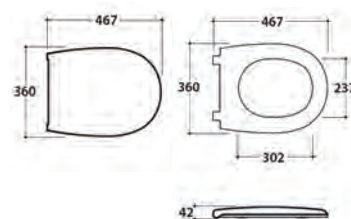

CURVA TECNICA REGOLABILE MINI



Con kit di fissaggio.
La regolazione varia in base al WC sul quale verrà installata.

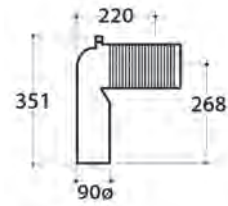

codice	sigla	UM	min. ord.	cat.	prezzo (€)
3702345	VA092	NR	1	09	50,36

CURVA TECNICA REGOLABILE MEDIA



Con kit di fissaggio.
La regolazione varia in base al WC sul quale verrà installata.

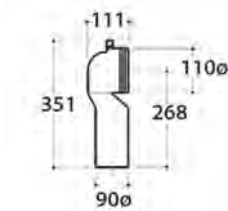

codice	sigla	UM	min. ord.	cat.	prezzo (€)
3702346	VA093	NR	1	09	41,48

CURVA TECNICA REGOLABILE MAXI



Con kit di fissaggio.
La regolazione varia in base al WC sul quale verrà installata.

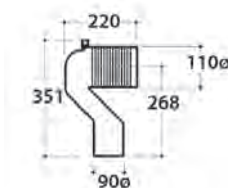

codice	sigla	UM	min. ord.	cat.	prezzo (€)
3702347	VA094	NR	1	09	50,36

RACCORDO SCARICO A PAVIMENTO



Per wc 4ALL MULTI 2.0 (3702377) da utilizzare in combinazione alla curva tecnica 3702345

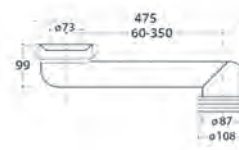

codice	sigla	regolazione (cm)	UM	min. ord.	cat.	prezzo (€)
3702349	VA026	14 - 31	NR	1	09	165,88

RACCORDO SCARICO A PARETE



Estensibile e flessibile per wc 4ALL MULTI 2.0 (3702377)



codice	sigla	regolazione (cm)	UM	min. ord.	cat.	prezzo (€)
3702390	VA027	21 - 25	NR	1	09	111,08

CERAMICA SANITARIA

CURVE TECNICHE WC E ACCESSORI

RACCORDO A PARETE

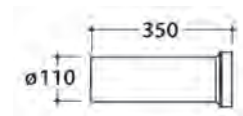

codice	sigla	dimensioni	UM	min. ord.	cat.	prezzo (€)
3702325	VA076	Ø 110 x 350	NR	1	09	22,20

RACCORDO ECCENTRICO

Per entrata acqua con spostamento di 1,5 cm

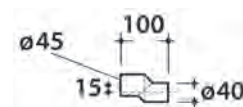

codice	sigla	dimensioni	UM	min. ord.	cat.	prezzo (€)
3702348	VA086	Ø 40 x 100	NR	1	09	11,84

RACCORDO ECCENTRICO

Per entrata acqua, con spostamento di 1,5 cm

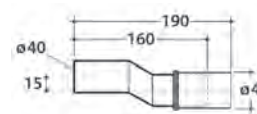

codice	sigla	dimensioni	UM	min. ord.	cat.	prezzo (€)
3702391	VA028	Ø 40 x 190	NR	1	09	14,80

RIDUTTORE FLUSSO DI SCARICO



codice	sigla	UM	min. ord.	cat.	prezzo (€)
3702333	VA132	NR	1	09	11,84

LE CIOTOLE DA APPOGGIO

Piletta non a corredo

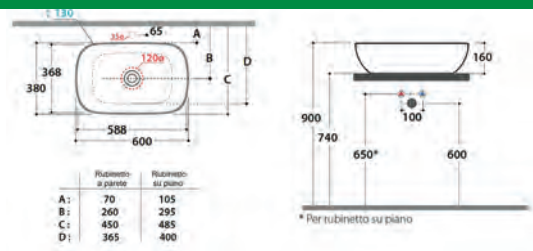

codice	sigla	finitura	dimensioni (cm)	UM	min. ord.	pz. pallet	cat.	prezzo (€)
3602080	B6R60BI	bianco lucido	60x38x16	NR	1	24	04	396,27
3603080	B6R60BO	bianco opaco	60x38x16	NR	1	24	04	594,39

LE CIOTOLE DA APPOGGIO - OVALI

Piletta non a corredo

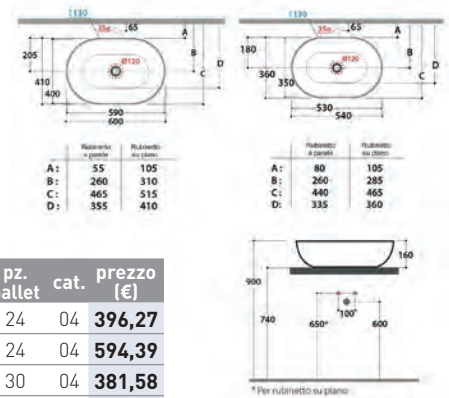

codice	sigla	finitura	dimensioni (cm)	UM	min. ord.	pz. pallet	cat.	prezzo (€)
3602081	B6060BI	bianco lucido	60x41x16	NR	1	24	04	396,27
3603081	B6060BO	bianco opaco	60x41x16	NR	1	24	04	594,39
3602082	B6054BI	bianco lucido	54x36x16	NR	1	30	04	381,58
3603082	B6054BO	bianco opaco	54x36x16	NR	1	30	04	572,38

LE CIOTOLE DA APPOGGIO - TONDE

Piletta non a corredo

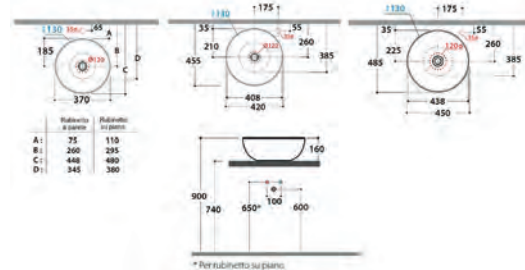

codice	sigla	finitura	dimensioni (cm)	UM	min. ord.	pz. pallet	cat.	prezzo (€)
3602084	B6T45BI	bianco lucido	Ø 45	NR	1	30	04	403,59
3603084	B6T45BO	bianco opaco	Ø 45	NR	1	30	04	604,87
3602085	B6T42BI	bianco lucido	Ø 42	NR	1	30	04	383,69
3603085	B6T42BO	bianco opaco	Ø 42	NR	1	30	04	575,52
3602083	B6T37BI	bianco lucido	Ø 37	NR	1	36	04	346,98
3603083	B6T37BO	bianco opaco	Ø 37	NR	1	36	04	519,96

LAVABO SOTTOPIANO



codice	sigla	dimensioni (cm)	UM	min. ord.	pz. pallet	cat.	prezzo (€)
3602062	VA083BI	60x40x20	NR	1	24	04	326,93

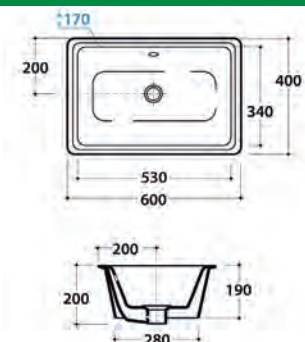

CERAMICA SANITARIA

ARTICOLI COMPLEMENTARI

LAVABO AD ANGOLO

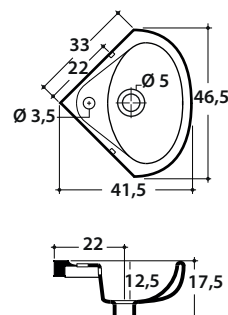

codice	sigla	dimensioni (cm)	UM	min. ord.	pz. pallet	cat.	prezzo (€)
3602070	VA020BI	46,5	NR	1	30	03	153,60

PILOZZO

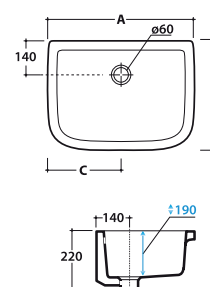

codice	sigla	AxBxC (cm)	UM	min. ord.	pz. pallet	cat.	prezzo (€)
3701601	VA044BI	60x45,5x30	NR	1	12	03	201,63
3701602	VA043BI	51x44x25	NR	1	18	03	171,48
3701603	VA042BI	44x36x22	NR	1	30	03	160,80

CASSETTA ALTA

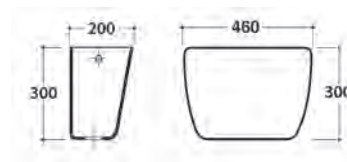

codice	sigla	dimensioni (cm)	UM	min. ord.	pz. pallet	cat.	prezzo (€)
3701703	VA009BI	42x30	NR	1	24	03	138,90

ORINATOIO SOSPESO

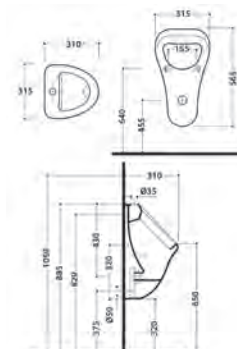

codice	sigla	dimensioni (cm)	UM	min. ord.	pz. pallet	cat.	prezzo (€)
3701704	VA089BI	31,5x31	NR	1	12	03	194,40

FERDY QUADRATO H. 6,5 cm

Sifone non a corredo



codice	sigla	AxBxC (cm)	UM	min. ord.	pz. pallet	cat.	prezzo (€)
3517001	PFPD07007065BI	70x70x18	NR	1	19	04	178,75
3517002	PFPD08008065BI	80x80x19	NR	1	19	04	187,71
3517003	PFPD09009065BI	90x90x21	NR	1	16	04	214,52

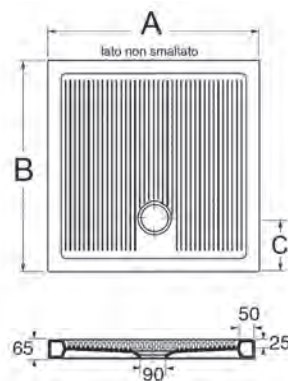

FERDY RETTANGOLARE H. 6,5 cm

Sifone non a corredo



codice	sigla	AxBxC (cm)	UM	min. ord.	pz. pallet	cat.	prezzo (€)
3517004	PFPD09007065BI	90x70x17	NR	1	16	04	196,39
3517005	PFPD10007065BI	100x70x17	NR	1	16	04	210,06
3517006	PFPD12007065BI	120x70x18	NR	1	14	04	262,79
3517007	PFPD14007065BI	140x70x17	NR	1	8	04	368,25
3517008	PFPD10008065BI	100x80x18	NR	1	16	04	254,73
3517009	PFPD12008065BI	120x80x18	NR	1	14	04	294,97
3517010	PFPD14008065BI	140x80x18	NR	1	8	04	388,80

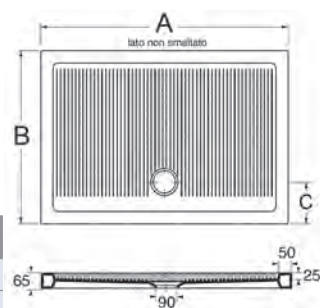

FERDY ANGOLARE H. 6,5 cm

Sifone non a corredo



codice	sigla	AxBxCxD (cm)	UM	min. ord.	pz. pallet	cat.	prezzo (€)
3517011	PFPDA9009065BI	90x90x63x35	NR	1	16	04	196,63

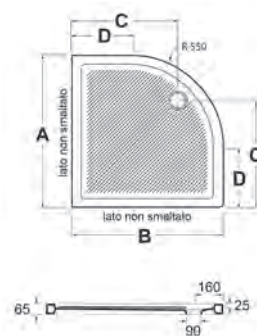

PIATTI DOCCIA

PIATTI DOCCIA IN ARDESIA

PETRA BLUES H. 3 cm

Piatto doccia in composito di minerali naturali e resina (texture Natural Stone), con finitura sui 4 lati.

A corredo piletta sifonata con portata da 24 lt/min e griglia copripiletta double face: da un lato in acciaio satinato, dall'altro stesso colore del piatto.

Nel modello quadrato la piletta sifonata è centrale.

Possibilità di tagli su misura direttamente in produzione.



PIACEVOLE
AL TATTO



MATERIALE
LEGGERO



RESISTENZA
ANTIBATTERICA



SUPERFICIE
ANTISCIVOLO



RESISTENZA
ALL'URTO



SUPERFICIE
ANTIMACCHIA



RESISTENZA
TERMICA E UV



SUPERFICIE
INALTERABILE



RITAGLIABILE
IN OPERA



RITAGLIABILE
RIPRISTINATO



BIANCO MATT
RAL 9003
Cod. BM

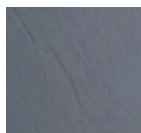

GRIGIO MATT
RAL 7004
Cod. GM

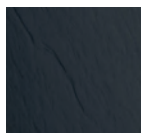

ANTRACITE MATT
RAL 7024
Cod. NM



PANNA MATT
RAL 1013
Cod. PM

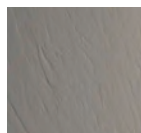

GREIGE MATT
RAL 7030
Cod. TM

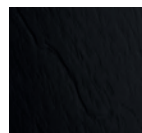

NERO MATT
RAL 9004
Cod. DM



codice [*]	AxBxC (cm)	UM	min. ord.	pz. pallet	cat.	prezzo (€)
35501BM	70x70x33	NR	1	10	04	376,60
35502BM	75x75x33	NR	1	10	04	388,74
35503BM	80x80x37	NR	1	10	04	443,41
35504BM	90x70x33	NR	1	10	04	422,15
35505BM	90x90x45	NR	1	10	04	464,67
35506BM	100x70x33	NR	1	10	04	443,41
35507BM	100x80x37	NR	1	10	04	443,41
35508BM	110x70x33	NR	1	10	04	519,34
35509BM	110x80x37	NR	1	10	04	498,08
35510BM	120x70x33	NR	1	10	04	476,82
35511BM	120x80x37	NR	1	10	04	510,23
35512BM	120x90x43	NR	1	10	04	607,41
35513BM	130x70x33	NR	1	10	04	552,75
35514BM	130x80x37	NR	1	10	04	586,15
35515BM	140x70x33	NR	1	10	04	543,64
35516BM	140x80x37	NR	1	10	04	564,90
35517BM	140x90x43	NR	1	10	04	665,12
35518BM	150x70x33	NR	1	10	04	607,41
35519BM	150x80x37	NR	1	10	04	652,97
35520BM	150x90x43	NR	1	10	04	774,45
35521BM	150x100x42	NR	1	10	04	765,34
35522BM	160x70x33	NR	1	10	04	674,23
35523BM	160x80x37	NR	1	10	04	674,23
35524BM	170x70x33	NR	1	10	04	698,53
35525BM	170x80x37	NR	1	10	04	707,64
35526BM	170x90x37	NR	1	10	04	895,94
35527BM	180x80x37	NR	1	10	04	765,34
35528BM	180x90x37	NR	1	10	04	862,53
35529BM	190x90x42	NR	1	10	04	1.096,38
35530BM	200x100x32	NR	1	10	04	1.205,72

[*] Le ultime due lettere del codice, identificano la finitura.

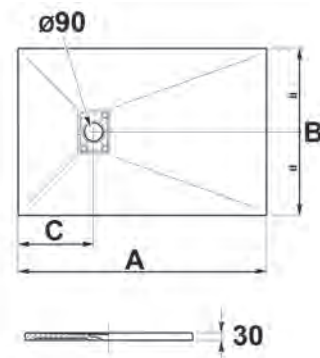

PETRA BLUES ANGOLARE H. 3 cm



codice [*]	AxBxC (cm)	UM	min. ord.	pz. pallet	cat.	prezzo (€)
35531BM	80x80x18	NR	1	10	04	443,41
35532BM	90x90x28	NR	1	10	04	498,08

[*] Le ultime due lettere del codice, identificano la finitura.

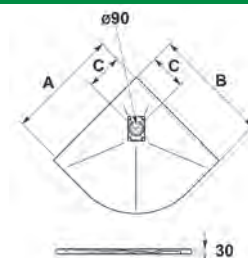

TAGLIO SU MISURA PETRA BLUES

NOVITÀ!

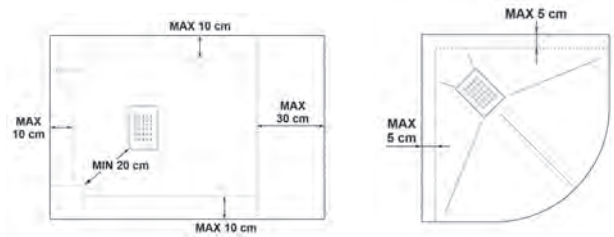

codice	descrizione	UM	min. ord.	cat.	prezzo (€)
3540302	Costo per ogni taglio	NR	1	04	65,10

COPRILETTA MATERICA PETRA BLUES

NOVITÀ!



Composito di minerali naturali e resina con la stessa texture e lo stesso colore del piatto doccia

codice (*)	finitura	UM	min. ord.	cat.	prezzo (€)
35617BM	bianco matt - cromo	NR	1	04	74,41

(*) Le ultime due lettere del codice, identificano la finitura.

COPRILETTA PETRA BLUES

NOVITÀ!



A corredo del piatto doccia, da un lato in acciaio satinato e dall'altro stesso colore del piatto doccia.

codice (*)	descrizione	finitura	UM	min. ord.	cat.	prezzo (€)
35610BM	ricambio	bianco matt - cromo	NR	1	04	48,68

(*) Le ultime due lettere del codice, identificano la finitura.

SIFONE PIATTO DOCCIA CON FORO D.90, SENZA GRIGLIA, RIBASSATO

Senza griglia copripiletta, sifone e cestello ferma-capelli amovibili, guarnizione doppio labbro per piatti doccia in acrilico e in ceramica, uscita liscia D.40 per attacco diretto. Basso ingombro, portata d'acqua 27 lt/min. Fissaggio con viti.

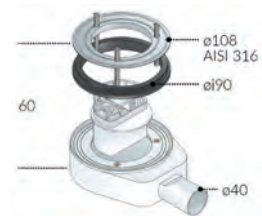

codice	sigla	piletta Ø	uscita Ø	UM	min. ord.	conf.	cat.	prezzo (€)
2303012	6621.001.6.	110	40	NR	1	16	01	36,17

PIATTI DOCCIA

PIATTI DOCCIA IN ARDESIA

PETRA JAZZ H. 3 cm

Piatto doccia in composito di minerali naturali e resina (texture Ardesia Matt), con finitura sui 4 lati.

A corredo piletta sifonata con portata da 24 lt/min e griglia copripiletta double face: da un lato in acciaio lucido a specchio, dall'altro stesso colore del piatto.

Nel modello quadrato la piletta sifonata è centrale.

Possibilità di tagli su misura direttamente in produzione.



PIACEVOLE
AL TATTO



MATERIALE
LEGGERO



RESISTENZA
ANTIBATTERICA



SUPERFICIE
ANTISCIVOLO



RESISTENZA
ALL'URTO



SUPERFICIE
ANTIMACCHIA



RESISTENZA
TERMICA E UV



SUPERFICIE
INALTERABILE



RITAGLIABILE
IN OPERA



RITAGLIABILE
RIPRISTINATO



BIANCO MATT
RAL 9003
Cod. BM

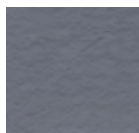

GRIGIO MATT
RAL 7004
Cod. GM

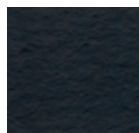

ANTRACITE MATT
RAL 7024
Cod. NM

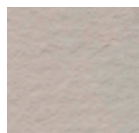

PANNA MATT
RAL 1013
Cod. PM

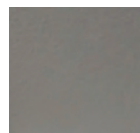

GREIGE MATT
RAL 7030
Cod. TM



NERO MATT
RAL 9004
Cod. DM



codice (*)	AxBxC (cm)	UM	min. ord.	pz. pallet	cat.	prezzo (€)
35460BM	70x70x33	NR	1	10	04	376,60
35461BM	75x75x33	NR	1	10	04	388,74
35462BM	80x80x37	NR	1	10	04	443,41
35463BM	90x70x33	NR	1	10	04	422,15
35464BM	90x90x45	NR	1	10	04	464,67
35465BM	100x70x33	NR	1	10	04	443,41
35466BM	100x80x37	NR	1	10	04	443,41
35467BM	110x70x33	NR	1	10	04	519,34
35468BM	110x80x37	NR	1	10	04	498,08
35469BM	120x70x33	NR	1	10	04	476,82
35470BM	120x80x37	NR	1	10	04	510,23
35471BM	120x90x43	NR	1	10	04	607,41
35472BM	130x70x33	NR	1	10	04	552,75
35473BM	130x80x37	NR	1	10	04	586,15
35474BM	140x70x33	NR	1	10	04	543,64
35475BM	140x80x37	NR	1	10	04	564,90
35476BM	140x90x43	NR	1	10	04	665,12
35477BM	150x70x33	NR	1	10	04	607,41
35478BM	150x80x37	NR	1	10	04	652,97
35479BM	150x90x43	NR	1	10	04	774,45
35480BM	150x100x42	NR	1	10	04	765,34
35481BM	160x70x33	NR	1	10	04	674,23
35482BM	160x80x37	NR	1	10	04	674,23
35483BM	170x70x33	NR	1	10	04	698,53
35484BM	170x80x37	NR	1	10	04	707,64
35485BM	170x90x37	NR	1	10	04	895,94
35486BM	180x80x37	NR	1	10	04	765,34
35487BM	180x90x37	NR	1	10	04	862,53
35488BM	190x90x42	NR	1	10	04	1.096,38
35489BM	200x100x32	NR	1	10	04	1.205,72

(*) Le ultime due lettere del codice, identificano la finitura.

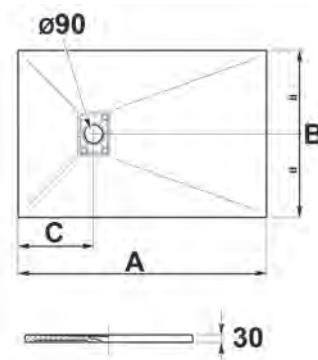

PETRA JAZZ ANGOLARE H. 3 cm



codice (*)	AxBxC (cm)	UM	min. ord.	pz. pallet	cat.	prezzo (€)
35490BM	80x80x18	NR	1	10	04	443,41
35491BM	90x90x28	NR	1	10	04	498,08

(*) Le ultime due lettere del codice, identificano la finitura.

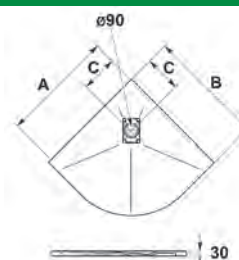

TAGLIO SU MISURA PETRA JAZZ

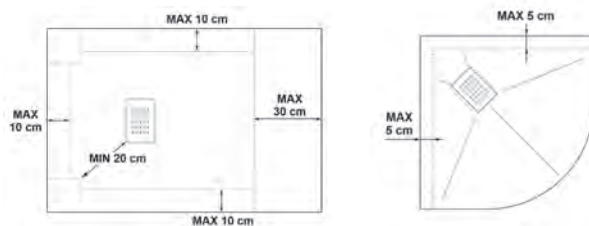

codice	descrizione	UM	min. ord.	cat.	prezzo (€)
3540302	Costo per ogni taglio	NR	1	04	65,10

COPRILETTA MATERICA PETRA JAZZ



Composito di minerali naturali e resina con la stessa texture e lo stesso colore del piatto doccia

codice (*)	finitura	UM	min. ord.	cat.	prezzo (€)
35616BM	bianco matt - cromo	NR	1	04	74,41

(*) Le ultime due lettere del codice, identificano la finitura.

COPRILETTA PETRA JAZZ



A corredo del piatto doccia, da un lato in acciaio satinato e dall'altro stesso colore del piatto doccia.

codice (*)	descrizione	finitura	UM	min. ord.	cat.	prezzo (€)
35610BM	ricambio	bianco matt - cromo	NR	1	04	48,68

(*) Le ultime due lettere del codice, identificano la finitura.

SIFONE PIATTO DOCCIA CON FORO D.90, SENZA GRIGLIA, RIBASSATO

Senza griglia copripiletta, sifone e cestello ferma-capelli amovibili, guarnizione doppio labbro per piatti doccia in acrilico e in ceramica, uscita liscia D.40 per attacco diretto. Basso ingombro, portata d'acqua 27 lt/min. Fissaggio con viti.

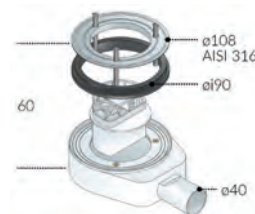

codice	sigla	piletta Ø	uscita Ø	UM	min. ord.	conf.	cat.	prezzo (€)
2303012	6621.001.6.	110	40	NR	1	16	01	36,17

PIATTI DOCCIA

PIATTI DOCCIA IN ARDESIA

PETRA TECHNO H. 3 cm

Piatto doccia in composito di minerali naturali e resina (texture Ardesia Matt), con finitura sui 4 lati.
A corredo piletta sifonata con portata da 24 lt/min e griglia copripiletta in acciaio dello stesso colore del piatto.

Nel modello quadrato la piletta sifonata è centrale.

Possibilità di tagli su misura direttamente in produzione.



PIACEVOLE
AL TATTO



MATERIALE
LEGGERO



RESISTENZA
ANTIBATTERICA



SUPERFICIE
ANTISCIVOLO



RESISTENZA
ALL'URTO



SUPERFICIE
ANTIMACCHIA



RESISTENZA
TERMICA E UV



SUPERFICIE
INALTERABILE



RITAGLIABILE
IN OPERA



RITAGLIABILE
RIPRISTINATO

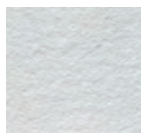

BIANCO MATT
RAL 9003
Cod. BM

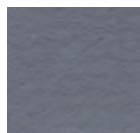

GRIGIO MATT
RAL 7004
Cod. GM

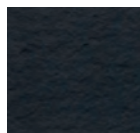

ANTRACITE MATT
RAL 7024
Cod. NM

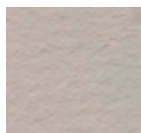

PANNA MATT
RAL 1013
Cod. PM

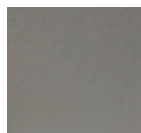

GREIGE MATT
RAL 7030
Cod. TM



NERO MATT
RAL 9004
Cod. DM

SANITARI



NOVITÀ!

codice (*)	AxB (cm)	UM	min. ord.	pz. pallet	cat.	prezzo (€)
35701BM	70x70	NR	1	10	04	373,92
35702BM	75x75	NR	1	10	04	400,16
35703BM	80x80	NR	1	10	04	419,84
35704BM	90x70	NR	1	10	04	400,16
35705BM	90x90	NR	1	10	04	452,64
35706BM	100x70	NR	1	10	04	419,84
35707BM	100x80	NR	1	10	04	432,96
35708BM	100x90	NR	1	10	04	459,20
35709BM	100x100	NR	1	10	04	537,93
35710BM	110x70	NR	1	10	04	472,33
35711BM	110x80	NR	1	10	04	498,57
35712BM	120x70	NR	1	10	04	426,40
35713BM	120x80	NR	1	10	04	485,45
35714BM	120x90	NR	1	10	04	570,73
35715BM	120x100	NR	1	10	04	629,77
35716BM	130x70	NR	1	10	04	557,61
35717BM	130x80	NR	1	10	04	577,29
35718BM	140x70	NR	1	10	04	511,69
35719BM	140x80	NR	1	10	04	551,05
35720BM	140x90	NR	1	10	04	656,01
35721BM	140x100	NR	1	10	04	721,61
35722BM	150x70	NR	1	10	04	590,41
35723BM	150x80	NR	1	10	04	656,01
35724BM	150x90	NR	1	10	04	721,61
35725BM	150x100	NR	1	10	04	774,09
35726BM	160x70	NR	1	10	04	656,01
35727BM	160x80	NR	1	10	04	662,57
35728BM	160x90	NR	1	10	04	760,97
35729BM	160x100	NR	1	10	04	800,33
35730BM	170x70	NR	1	10	04	629,77
35731BM	170x80	NR	1	10	04	695,37
35732BM	170x90	NR	1	10	04	793,77
35733BM	180x80	NR	1	10	04	695,37
35734BM	180x90	NR	1	10	04	806,89
35735BM	180x100	NR	1	10	04	865,93
35736BM	190x90	NR	1	10	04	852,81
35737BM	200x100	NR	1	10	04	957,77

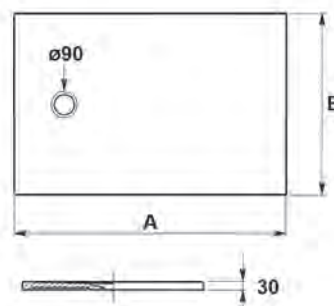

[*] Le ultime due lettere del codice, identificano la finitura.

PETRA TECHNO ANGOLARE H. 3 cm

NOVITÀ!

codice (*)	AxBx (cm)	UM	min. ord.	pz. pallet	cat.	prezzo (€)
35738BM	80x80	NR	1	10	04	419,84
35739BM	90x90	NR	1	10	04	498,57

(*) Le ultime due lettere del codice, identificano la finitura.

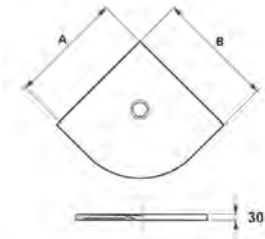

TAGLIO SU MISURA PETRA TECHNO

NOVITÀ!

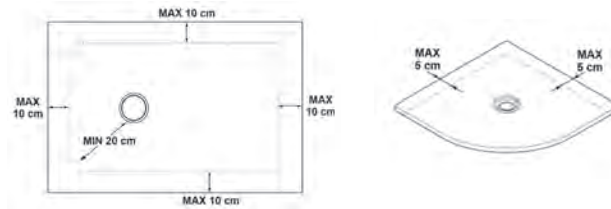

codice	descrizione	UM	min. ord.	cat.	prezzo (€)
3540302	Costo per ogni taglio	NR	1	04	65,10

COPRILETTA MATERICA PETRA TECHNO

NOVITÀ!

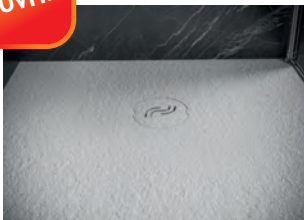

Composito di minerali naturali e resina con la stessa texture e lo stesso colore del piatto doccia

codice (*)	finitura	UM	min. ord.	cat.	prezzo (€)
35615BM	bianco matt - cromo	NR	1	04	74,41

(*) Le ultime due lettere del codice, identificano la finitura.

COPRILETTA PETRA TECHNO

A corredo del piatto doccia, in acciaio verniciato dello stesso colore del piatto.

NOVITÀ!



codice (*)	descrizione	finitura	UM	min. ord.	cat.	prezzo (€)
35619BM	ricambio	bianco matt - cromo	NR	1	04	38,27

(*) Le ultime due lettere del codice, identificano la finitura.

SIFONE PIATTO DOCCIA CON FORO D.90, SENZA GRIGLIA, RIBASSATO

Senza griglia copripiletta, sifone e cestello ferma-capelli amovibili, guarnizione doppio labbro per piatti doccia in acrilico e in ceramica, uscita liscia D.40 per attacco diretto. Basso ingombro, portata d'acqua 27 lt/min. Fissaggio con viti.

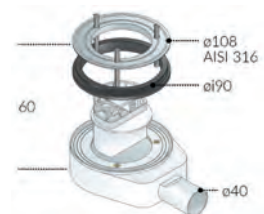

codice	sigla	piletta Ø	uscita Ø	UM	min. ord.	conf.	cat.	prezzo (€)
2303012	6621.001.6.	110	40	NR	1	16	01	36,17

PIATTI DOCCIA

PIATTI DOCCIA IN ARDESIA

PETRA ROCK H. 2,6 cm

Piatto doccia in composito di minerali naturali e resina (texture Ardesia Matt), con finitura sui 4 lati.

A corredo piletta sifonata centrale con portata da 24 lt/min e griglia copripietia double face: da un lato in acciaio lucido a specchio, dall'altro stesso colore del piatto.



PIACEVOLE
AL TATTO



MATERIALE
LEGGERO



RESISTENZA
ANTIBATTERICA



SUPERFICIE
ANTISCIVOLO



RESISTENZA
ALL'URTO



SUPERFICIE
ANTIMACCHIA



RESISTENZA
TERMICA E UV



SUPERFICIE
INALTERABILE



RITAGLIABILE
IN OPERA



RITAGLIABILE
RIPRISTINATO



BIANCO MATT
RAL 9003
Cod. BM

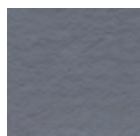

GRIGIO MATT
RAL 7004
Cod. GM

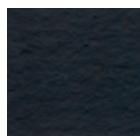

ANTRACITE MATT
RAL 7024
Cod. NM

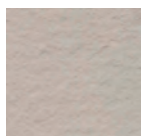

PANNA MATT
RAL 1013
Cod. PM

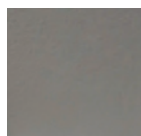

GREIGE MATT
RAL 7030
Cod. TM

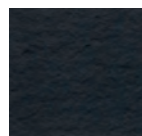

NERO MATT
RAL 9004
Cod. DM



codice (*)	AxB (cm)	UM	min. ord.	pz. pallet	cat.	prezzo (€)
35420BM	70x70	NR	1	10	04	343,19
35421BM	75x75	NR	1	10	04	355,34
35422BM	80x80	NR	1	10	04	376,60
35423BM	90x70	NR	1	10	04	355,34
35424BM	90x90	NR	1	10	04	422,15
35425BM	100x70	NR	1	10	04	388,74
35426BM	100x80	NR	1	10	04	388,74
35427BM	100x90	NR	1	10	04	440,38
35428BM	100x100	NR	1	10	04	543,64
35429BM	110x70	NR	1	10	04	422,15
35430BM	110x80	NR	1	10	04	443,41
35431BM	120x70	NR	1	10	04	410,00
35432BM	120x80	NR	1	10	04	431,26
35433BM	120x90	NR	1	10	04	543,64
35434BM	120x100	NR	1	10	04	561,86
35435BM	130x70	NR	1	10	04	498,08
35436BM	130x80	NR	1	10	04	519,34
35437BM	140x70	NR	1	10	04	510,23
35438BM	140x80	NR	1	10	04	519,34
35439BM	140x90	NR	1	10	04	607,41
35440BM	140x100	NR	1	10	04	707,64
35441BM	150x70	NR	1	10	04	552,75
35442BM	150x80	NR	1	10	04	577,04
35443BM	150x90	NR	1	10	04	622,60
35444BM	150x100	NR	1	10	04	698,53
35445BM	160x70	NR	1	10	04	586,15
35446BM	160x80	NR	1	10	04	607,41
35447BM	160x90	NR	1	10	04	731,93
35448BM	160x100	NR	1	10	04	713,71
35449BM	170x70	NR	1	10	04	619,56
35450BM	170x80	NR	1	10	04	640,82
35451BM	170x90	NR	1	10	04	765,34
35452BM	180x80	NR	1	10	04	698,53
35453BM	180x90	NR	1	10	04	786,60
35454BM	180x100	NR	1	10	04	841,27
35455BM	190x90	NR	1	10	04	713,71
35456BM	200x100	NR	1	10	04	829,12

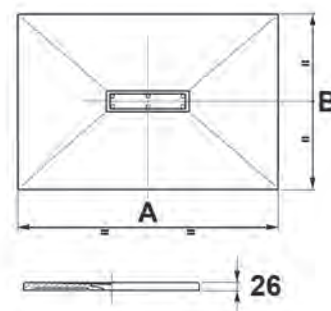

(*) Le ultime due lettere del codice, identificano la finitura.

TAGLIO SU MISURA PETRA ROCK

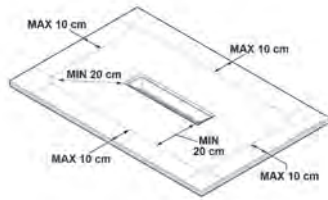

codice (*)	descrizione	UM	min. ord.	cat.	prezzo (€)
3540302	Costo per ogni taglio	NR	1	04	65,10

COPRILETTA MATERICA PETRA ROCK



Composito di minerali naturali e resina con la stessa texture e lo stesso colore del piatto doccia

codice (*)	finitura	UM	min. ord.	cat.	prezzo (€)
35618BM	bianco matt - cromo	NR	1	04	74,41

(*) Le ultime due lettere del codice, identificano la finitura.

COPRILETTA PETRA ROCK



A corredo del piatto doccia, in acciaio verniciato dello stesso colore del piatto

codice (*)	descrizione	finitura	UM	min. ord.	cat.	prezzo (€)
35611BM	ricambio	bianco matt - cromo	NR	1	04	46,35

(*) Le ultime due lettere del codice, identificano la finitura.

PILETTA PETRA ROCK SENZA GRIGLIA



A corredo del piatto doccia, piletta rettangolare sifonata ispezionabile

codice	descrizione	dimensioni (cm)	Ø uscita	UM	min. ord.	cat.	prezzo (€)
3540303	ricambio	192x47	40	NR	1	04	71,01

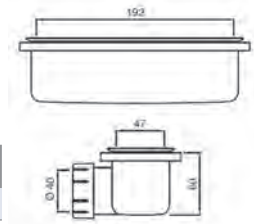

PIATTI DOCCIA

PIATTI DOCCIA IN ARDESIA

PETRA CLASSIC H. 2 cm

Piatto doccia in composito di minerali naturali e resina (texture Urban Grip), con finitura sui 4 lati.
A corredo griglia copripiletta in acciaio bianca.

Piletta sifonata non a corredo.

Possibilità di tagli su misura direttamente in produzione.



PIACEVOLE
AL TATTO



MATERIALE
LEGGERO



RESISTENZA
ANTIBATTERICA



SUPERFICIE
ANTISCIVOLO



RESISTENZA
ALL'URTO



SUPERFICIE
ANTIMACCHIA



RESISTENZA
TERMICA E UV



SUPERFICIE
INALTERABILE



RITAGLIABILE
IN OPERA



RITAGLIABILE
RIPRISTINATO



codice (*)	AxBxC (cm)	UM	min. ord.	pz. pallet	cat.	prezzo (€)
35541BM	80x80x20	NR	1	10	04	274,78
35542BM	90x70x20	NR	1	10	04	262,76
35543BM	90x75x20	NR	1	10	04	289,82
35544BM	90x90x20	NR	1	10	04	328,91
35545BM	100x70x20	NR	1	10	04	289,82
35546BM	100x75x20	NR	1	10	04	313,88
35547BM	100x80x20	NR	1	10	04	301,85
35548BM	100x90x20	NR	1	10	04	368,00
35549BM	120x70x20	NR	1	10	04	328,91
35550BM	120x75x20	NR	1	10	04	368,00
35551BM	120x80x20	NR	1	10	04	352,97
35552BM	120x90x20	NR	1	10	04	419,12
35553BM	140x70x20	NR	1	10	04	380,03
35554BM	140x80x20	NR	1	10	04	431,15
35555BM	140x90x20	NR	1	10	04	482,27
35556BM	160x70x35	NR	1	10	04	458,21
35557BM	160x80x35	NR	1	10	04	521,36
35558BM	160x90x35	NR	1	10	04	575,48
35559BM	170x70x35	NR	1	10	04	482,27
35560BM	170x80x35	NR	1	10	04	575,48
35561BM	180x80x35	NR	1	10	04	587,51
35562BM	180x90x35	NR	1	10	04	638,63

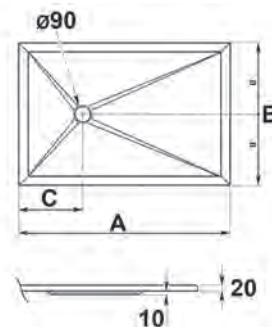

(*) Le ultime due lettere del codice, identificano la finitura.

TAGLIO SU MISURA PETRA CLASSIC

NOVITÀ!

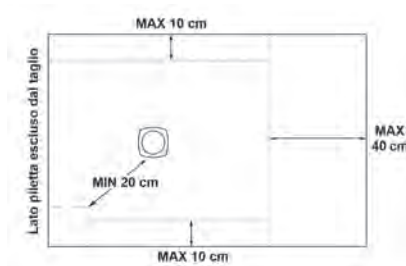

codice (*)	descrizione	UM	min. ord.	cat.	prezzo (€)
3540302	Costo per ogni taglio	NR	1	04	65,10

SIFONE PIATTO DOCCIA CON FORO D.90, SENZA GRIGLIA, RIBASSATO

Senza griglia copripiletta, sifone e cestello ferma-capelli amovibili, guarnizione doppio labbro per piatti doccia in acrilico e in ceramica, uscita liscia D.40 per attacco diretto. Basso ingombro, portata d'acqua 27 lt/min. Fissaggio con viti.

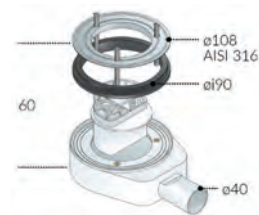

codice	sigla	piletta Ø	uscita Ø	UM	min. ord.	conf.	cat.	prezzo (€)
● 2303012	6621.001.6.	110	40	NR	1	16	01	36,17

ACCESSORI PIATTI DOCCIA IN ARDESIA

SIGILLANTE

Sigillante neutro antimuffa specifico per piatti doccia e rivestimenti, cartuccia 280 ml.



codice	finitura	UM	min. ord.	cat.	prezzo (€)
2005073	bianco	NR	1	04	29,76
2005076	grigio	NR	1	04	29,76
2005077	antracite	NR	1	04	29,76
2005074	panna	NR	1	04	29,76
2005075	greige	NR	1	04	29,76
2005078	nero	NR	1	04	29,76
2005079	trasparente	NR	1	04	29,76

KIT RIPARAZIONE GELCOAT

Composto da resina colorata e catalizzatore, pronto in 1 minuto.



codice	finitura	UM	min. ord.	cat.	prezzo (€)
2005173	bianco	NR	1	04	29,76
2005176	grigio	NR	1	04	29,76
2005177	antracite	NR	1	04	29,76
2005174	panna	NR	1	04	29,76
2005175	greige	NR	1	04	29,76
2005178	nero	NR	1	04	29,76

PIATTI DOCCIA

PANNELLI DI RIVESTIMENTO

KINEWALL



Pannelli murali decorativi per rivestire pareti doccia o altri spazi del bagno. Impermeabili e idrorepellenti realizzati in polietilene rivestito con 2 pannelli in alluminio (spessore totale 3 mm.) dalla superficie liscia, resistente a prodotti chimici, graffi e corrosione. Le finiture decorative sono stampate e verniciate. Possono essere installati su qualsiasi rivestimento senza alcun lavoro di preparazione, mediante incollaggio (senza viti o fori), con o senza profili. Possono essere tagliati in opera oppure direttamente in fabbrica (3569014)

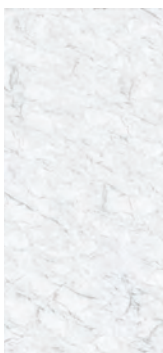

MARMO BIANCO



MARMO GRIGIO

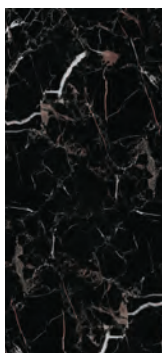

MARMO NERO E RAME

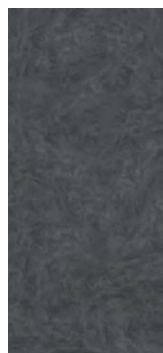

CEMENTO ANTRACITE

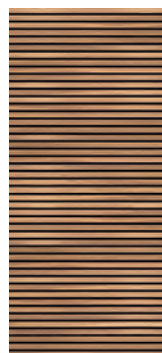

WOOD ORIZZONTALE



WOOD VERTICALE

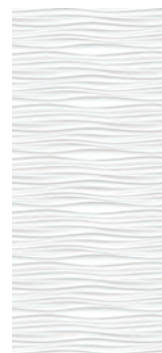

VAGUE

codice	sigla	dimensioni (cm)	finitura	UM	min. ord.	cat.	prezzo (€)
35650MB	PWK#1025MB	250x100	marmo bianco	NR	1	04	618,41
35650MG	PWK#1025MG	250x100	marmo grigio	NR	1	04	618,41
35650MD	PWK#1025MD	250x100	marmo nero rame	NR	1	04	618,41
35650BF	PWK#1025BF	250x100	cemento antracite	NR	1	04	618,41
35650CL	PWK#1025CL	250x100	wood orizzontale	NR	1	04	618,41
35650CW	PWK#1025CW	250x100	wood verticale	NR	1	04	618,41
35650VS	PWK#1025VS	250x100	vague	NR	1	04	618,41
35651MB	PWK#1525MB	250x150	marmo bianco	NR	1	04	791,86
35651MG	PWK#1525MG	250x150	marmo grigio	NR	1	04	791,86
35651MD	PWK#1525MD	250x150	marmo nero rame	NR	1	04	791,86
35651BF	PWK#1525BF	250x150	cemento antracite	NR	1	04	791,86
35651CL	PWK#1525CL	250x150	wood orizzontale	NR	1	04	791,86
35651CW	PWK#1525CW	250x150	wood verticale	NR	1	04	791,86
35651VS	PWK#1525VS	250x150	vague	NR	1	04	791,86

PROFILO ANGOLO INTERNO

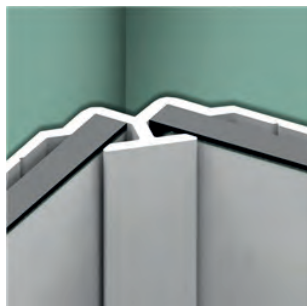

codice	sigla	dimensioni (cm)	finitura	UM	min. ord.	cat.	prezzo (€)
3569000	PROF6504AR250	250	argento brillante	NR	1	04	120,66
3569001	PROF6504BN250	250	bianco	NR	1	04	113,12
3569002	PROF6504NE250	250	nero	NR	1	04	113,12

PROFILO ANGOLO ESTERNO



codice	sigla	dimensioni (cm)	finitura	UM	min. ord.	cat.	prezzo (€)
3569009	PROF6507AR250	250	argento brillante	NR	1	04	128,21
3569010	PROF6507BN250	250	bianco	NR	1	04	113,12
3569011	PROF6507NE250	250	nero	NR	1	04	113,12

PROFILO A U DI FINITURA (A COPPIA)

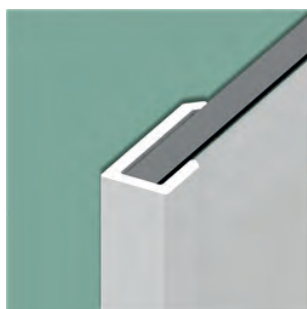

Per le estremità del pannello



codice	sigla	dimensioni (cm)	finitura	UM	min. ord.	cat.	prezzo (€)
3569006	PROF6506AR250	250	argento brillante	NR	1	04	196,08
3569007	PROF6506BN250	250	bianco	NR	1	04	135,75
3569008	PROF6506NE250	250	nero	NR	1	04	143,29

PROFILO A H



Per montaggio di 2 pannelli in linea



codice	sigla	dimensioni (cm)	finitura	UM	min. ord.	cat.	prezzo (€)
3569003	PROF6505AR250	250	argento brillante	NR	1	04	113,12
3569004	PROF6505BN250	250	bianco	NR	1	04	105,58
3569005	PROF6505NE250	250	nero	NR	1	04	105,58

KIT MONTAGGIO SENZA PROFILI

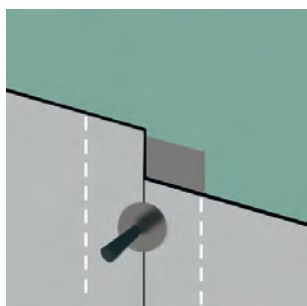

codice	sigla	dimensioni (cm)	descrizione	UM	min. ord.	cat.	prezzo (€)
3569012	PROFTOL184	249	banda metallica	NR	1	04	135,75
3569013	KITAIM78	-	kit tampone magnetico	NR	1	04	211,16

TAGLIO SU MISURA KINEWALL

Taglio in fabbrica



codice	sigla	descrizione	UM	min. ord.	cat.	prezzo (€)
3569014	PNWALLTAGLIO	costo per ogni taglio	NR	1	04	22,62

AUSILI BAGNO DISABILI

Serie CASUAL

SERIE CASUAL+ LAVABO

La Serie Casual+ ha una tonalità di bianco leggermente diversa rispetto alla serie Casual.



Meccanismo inclinazione gas: **4001067**
Kit piastra per pareti leggere: **4001066**

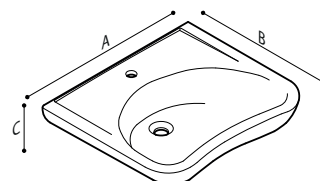

codice	sigla	AxBxC (cm)	UM	min. ord.	conf.	cat.	prezzo (€)
4001052	B40CMS07	64x55,5x17,7	NR	1	6	26	228,44

SERIE CASUAL+ WC APERTURA FRONTALE

La Serie Casual+ ha una tonalità di bianco leggermente diversa rispetto alla serie Casual.



Sedile originale:
4001059-4001065

Sedile non originale:
3203057

codice	sigla	scarico	altezza (cm)	UM	min. ord.	conf.	cat.	prezzo (€)
4001053	B40CB010	pavimento	48,5	NR	1	6	26	228,44
4001054	B40CB011	parete	49	NR	1	6	26	228,44

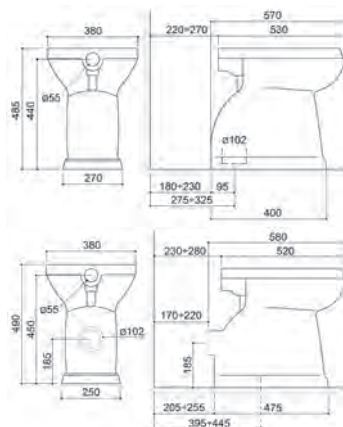

SERIE CASUAL WC



Sedile originale:
4001064

Sedile non originale:
3203058

codice	sigla	scarico	altezza (cm)	UM	min. ord.	conf.	cat.	prezzo (€)
4001061	B40CBC11	pavimento	50	NR	1	6	26	304,06
4001062	B40CBC12	parete	49,5	NR	1	6	26	304,06

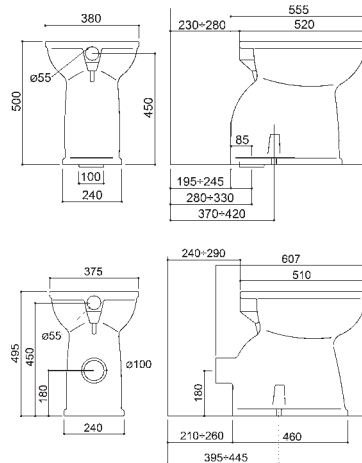

SERIE CASUAL BIDET



codice	sigla	AxBxC (cm)	altezza (cm)	UM	min. ord.	conf.	cat.	prezzo (€)
4001063	B40CIC11	38x52x50	50	NR	1	6	26	304,06

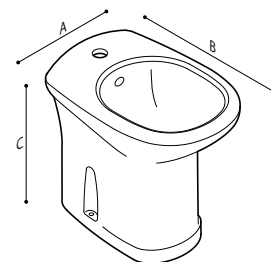

SEDILE TIPO CASUAL LEGNO CON APERTURA FRONTALE



Per WC:
4001053 - 4001054

codice	materiale	UM	min. ord.	conf.	cat.	prezzo (€)
● 3203057	legno	NR	1	6	05	76,80

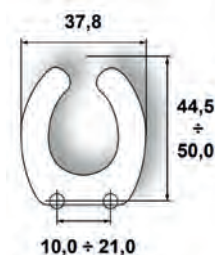

SEDILE TIPO CASUAL LEGNO SENZA APERTURA FRONTALE



Per WC:
4001061 - 4001062
Ricambi (pag. 165):
3203092 - Cerniere

codice	materiale	UM	min. ord.	conf.	cat.	prezzo (€)
● 3203058	legno	NR	1	6	05	67,84

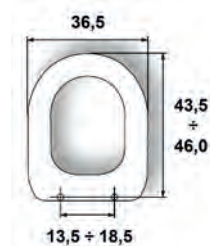

SERIE CASUAL SEDILE LEGNO



Per WC:
4001061 - 4001062

codice	sigla	materiale	UM	min. ord.	conf.	cat.	prezzo (€)
4001064	B41DEC35	legno	NR	1	6	17	141,13

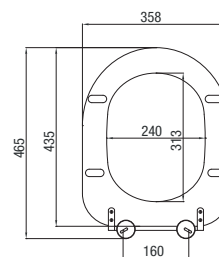

SERIE CASUAL / 140 SEDILE TERMOINDURENTE CON APERTURA FRONTALE



Adattabile al WC:
4001053 - 4001054 - 4001073

codice	sigla	materiale	UM	min. ord.	conf.	cat.	prezzo (€)
4001059	B41DE030	termoindurente	NR	1	6	17	117,39

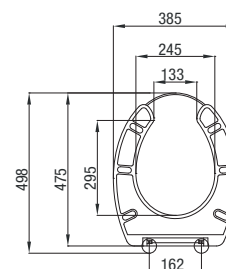

SERIE CASUAL / 140 SEDILE POLIPROPILENE CON APERTURA FRONTALE



Per WC:
4001053 - 4001054 - 4001073 - 4001074

codice	sigla	materiale	UM	min. ord.	conf.	cat.	prezzo (€)
4001065	B41DE042	polipropilene	NR	1	3	17	64,17

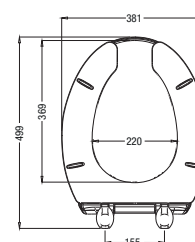

AUSILI BAGNO DISABILI

Serie 140

LAVABO



codice	sigla	AxBxC [cm]	UM	min. ord.	conf.	cat.	prezzo [€]
4001072	B40CMS14	66,5x58,5x22,5	NR	1	6	26	155,53

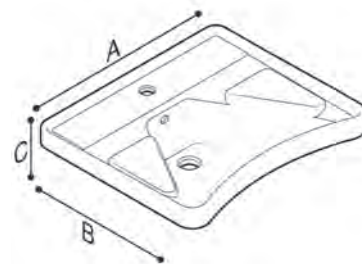

SANITARI

WC MULTI CON APERTURA FRONTALE



Sedile:
4001059-4001065

codice	sigla	descrizione	altezza [cm]	UM	min. ord.	conf.	cat.	prezzo [€]
4001073	B40CB014	multi	50	NR	1	6	26	155,53

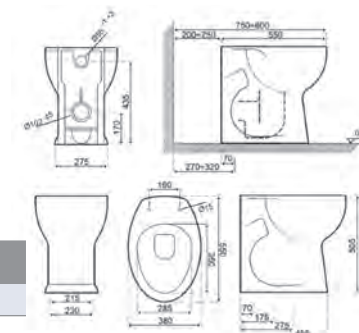

WC



Sedile:
4001065-4001076

codice	sigla	descrizione	altezza [cm]	UM	min. ord.	conf.	cat.	prezzo [€]
4001074	B40CBC14	multi	50	NR	1	6	26	169,28

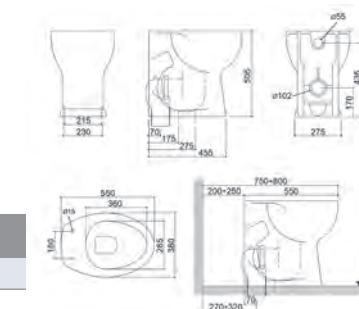

BIDET



codice	sigla	descrizione	altezza [cm]	UM	min. ord.	conf.	cat.	prezzo [€]
4001075	B40CIC14	monoforo	50	NR	1	6	26	169,28

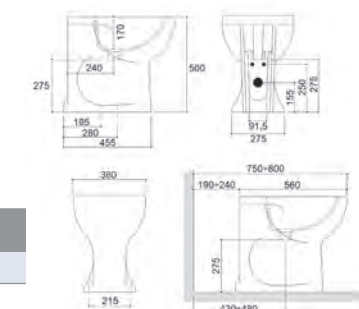

SEDILE SENZA APERTURA FRONTALE



Per WC:
4001074

codice	sigla	materiale	UM	min. ord.	conf.	cat.	prezzo [€]
4001076	B41DEC60	termoindurente	NR	1	5	17	117,39

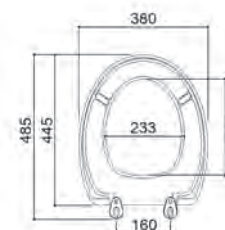

MOD.420 – PIATTO DOCCIA VETRO RESINA FILO PAVIMENTO

Sifone non a corredo

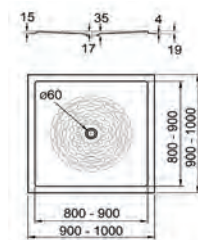

codice	sigla	AxBxC (cm)	UM	min. ord.	conf.	cat.	prezzo (€)
4002004	B40CPS02	80x80x1,5	NR	1	3	13	336,69
4002005	B40CPS01	90x90x1,5	NR	1	3	13	367,25

SIFONE DOCCIA RIBASSATO CON PILETTA

Per piatto doccia in vetroresina.

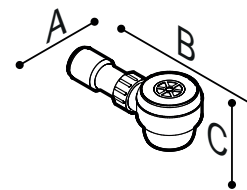

codice	sigla	AxBxC (cm)	UM	min. ord.	conf.	cat.	prezzo (€)
4002003	H52HAS03	9,6x23,3x8,9	NR	1	5	10	44,44

AUSILI BAGNO DISABILI

ACCESSORI

SPECCHIO RECLINABILE

In vetro di sicurezza

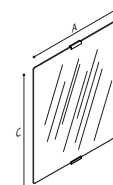

codice	sigla	AxBxC (cm)	UM	min. ord.	conf.	cat.	prezzo (€)
4009011	F41JPS20	44,5x7,3x59,5	NR	1	3	17	261,33

SANITARI

SERIE CASUAL - MECCANISMO INCLINAZIONE GAS



Per lavabo:
4001052

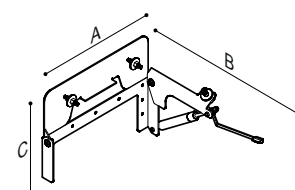

codice	sigla	AxBxC (cm)	UM	min. ord.	conf.	cat.	prezzo (€)
4001067	B41DAS16	53,2x47,9x37,6	NR	1	3	10	379,32

SERIE CASUAL - KIT PIASTRA PER PARETI LEGGERE



Per lavabo:
4001052

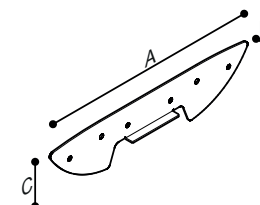

codice	sigla	AxBxC (cm)	UM	min. ord.	conf.	cat.	prezzo (€)
4001066	B41DCS19	58,9x2,4x13,2	NR	1	3	10	54,74

SIFONE A SNODO CON CURVA E ROSONE

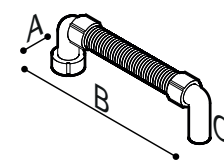

codice	sigla	AxBxC (cm)	UM	min. ord.	conf.	cat.	prezzo (€)
4003002	H51HAS02	5x31,9x10,1	NR	1	3	10	39,17

SPRAY 1



Kit doccetta in ABS composto da doccetta (1401019), flessibile antitorsione da 120 cm., supporto cromato.

codice	UM	min. ord. conf.	cat.	prezzo (€)
● 1401010	NR	1	02	37,26

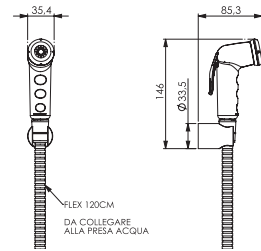

SPRAY 4



Kit doccetta in ABS composto da doccetta bianca (1401024), flessibile bianco da 120 cm., supporto bianco.

codice	UM	min. ord. conf.	cat.	prezzo (€)
● 1401027	NR	1	02	21,52

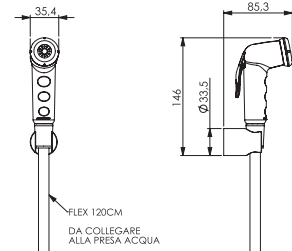

SPRAYJET 0

NOVITÀ!



Kit in ottone composto da doccetta in ottone con doppia funzione "idroscoopino e doccetta" (1401037), flessibile doppia aggaffatura da 120 cm. (1406011), supporto cromato, senza rubinetto.

codice	UM	min. ord. conf.	cat.	prezzo (€)
● 1401036	NR	1	02	51,85

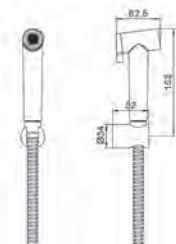

SPRAY 5

NOVITÀ!



Kit in ottone composto da doccetta in ottone con doppia funzione "idroscoopino e doccetta" (1401037), flessibile doppia aggaffatura da 120 cm. (1406011), con miscelatore esterno. Per prevenire il rischio di rottura del flessibile, si raccomanda di chiudere sempre il rubinetto dopo l'uso.

codice	UM	min. ord. conf.	cat.	prezzo (€)
● 1401033	NR	1	02	142,46

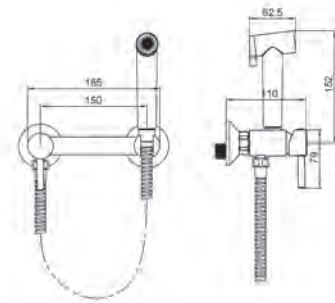

SPRAY 6

NOVITÀ!



Kit in ottone composto da doccetta in ottone con doppia funzione "idroscoopino e doccetta" (1401037), flessibile doppia aggaffatura da 120 cm. (1406011), con miscelatore ad incasso. Per prevenire il rischio di rottura del flessibile, si raccomanda di chiudere sempre il rubinetto dopo l'uso.



codice	finitura	UM	min. ord. conf.	cat.	prezzo (€)
● 1401034	cromo	NR	1	02	144,84
1401934	nero opaco	NR	1	02	306,31
1401834	simil acciaio	NR	1	02	299,57

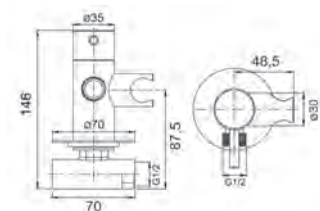

AUSILI BAGNO DISABILI

MANIGLIONI ACCIAIO VERNICIATO

Maniglioni in tubo di acciaio D.32x1,5 mm. verniciato in polvere epossidica, colore bianco caldo.
Piastra a 3 fori in acciaio zincato tropicalizzato spessore 3 mm.
Piastra di livellamento isolante con guarnizione e borchia in nylon - Certificazione TUV

MANIGLIONE LINEARE



codice	A - A1 (cm)	portata max (kg)	UM	min. ord. conf.	cat.	prezzo (€)
● 4101000	30 (inter.22)	150	NR	1	03	31,92
● 4101001	38 (inter.30)	150	NR	1	03	37,95
● 4101002	45 (inter.37)	150	NR	1	03	46,29
● 4101003	53 (inter.45)	150	NR	1	03	46,29
● 4101004	68 (inter.60)	150	NR	1	03	50,37
● 4101005	80 (inter.72)	150	NR	1	03	60,60
● 4101006	98 (inter.90)	150	NR	1	03	68,58
● 4101007	128 (inter.120)	120	NR	1	03	76,56

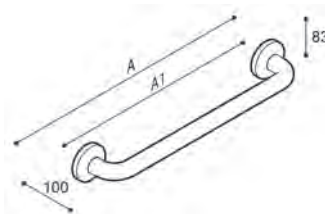

SANITARI

MANIGLIONE ANGOLARE A 135°



codice	portata max (kg)	UM	min. ord. conf.	cat.	prezzo (€)
● 4102001	150	NR	1	03	52,65

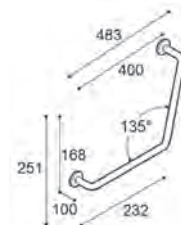

BARRA DI SOSTEGNO RIBALTABILE



codice	lunghezza (cm)	portata max (kg)	UM	min. ord. conf.	cat.	prezzo (€)
● 4104001	60	120	NR	1	10	128,10
● 4104002	80	100	NR	1	10	137,65

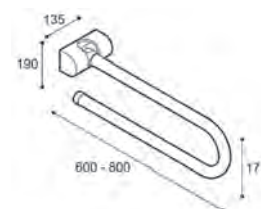

BARRA DI SOSTEGNO RIBALTABILE A PAVIMENTO



codice	portata max (kg)	UM	min. ord. conf.	cat.	prezzo (€)
● 4104004	120 kg in verticale 40 kg in orizzontale	NR	1	03	357,33

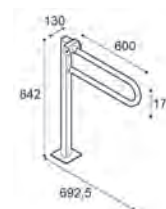

KIT PORTA ROTOLO INSERIBILE PER IMPUGNATURE FISSE E RIBALTABILI



codice	UM	min. ord. conf.	cat.	prezzo (€)
● 4104005	NR	1	03	23,10



AUSILI BAGNO DISABILI

MANIGLIONI ACCIAIO INOX LUCIDO

Maniglioni in tubo acciaio inossidabile AISI 304, D.32x1,5 mm, privo di saldature, finitura lucida. Flangia di fissaggio in acciaio con contro-flangia in poliammide. Copri-flangia in acciaio inox. Portata massima 150 kg.

MANIGLIONE LINEARE INOX



codice	sigla	AxA1 (cm)	UM	min. ord.	conf.	cat.	prezzo (€)
4301001	G29JAS01	35 (inter.27)	NR	1	1	11	80,71
4301002	G29JAS02	45 (inter.37)	NR	1	1	11	84,71
4301003	G29JAS03	55 (inter.47)	NR	1	1	11	91,38
4301004	G29JAS05	70 (inter.62)	NR	1	1	11	96,05
4301005	G29JAS09	120 (inter.112)	NR	1	1	11	126,06

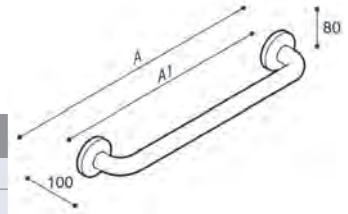

MANIGLIONE ANGOLARE A 135° INOX



codice	sigla	UM	min. ord.	conf.	cat.	prezzo (€)
4301006	G29JAS08	NR	1	1	11	97,38

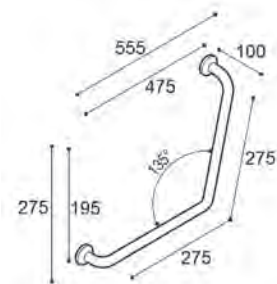

BARRA DI SOSTEGNO RIBALTABILE INOX

Conforme alla norma UNI EN 12182



codice	sigla	lunghezza (cm)	UM	min. ord.	conf.	cat.	prezzo (€)
4301007	G29JCS32	60	NR	1	1	11	260,13
4301008	G29JCS34	80	NR	1	1	11	280,81

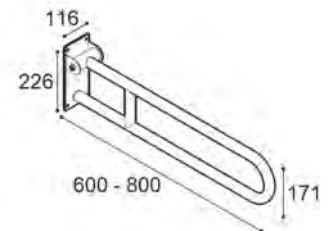

AUSILI BAGNO DISABILI

ALZAWATER

SEDILE ANTICONTATTO SENZA COPERCHIO RIALZATO 10 CM.

Universale termoplastico in resina infrangibile, completo di cerniere in metallo cromato e viti di fissaggio.



	codice	UM	min. ord.	conf.	cat.	prezzo (€)
●	3203056	NR	1	3	13	175,50

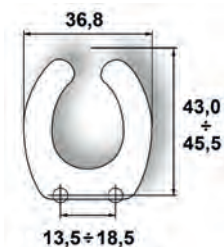

SEDILE ANTICONTATTO CON COPERCHIO RIALZATO 10 CM.

Universale termoplastico in resina infrangibile, completo di doppia cerniera in metallo cromato e viti di fissaggio.



	codice	UM	min. ord.	conf.	cat.	prezzo (€)
●	3203059	NR	1	3	13	243,00

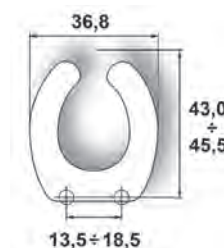

ALZAWATER CON SISTEMA DI BLOCCAGGIO

In polipropilene. Portata max 250 kg.



	codice	Altezza (H)	UM	min. ord.	conf.	cat.	prezzo (€)
●	3203060	10 cm	NR	1	42	02	58,24
●	3203063	14 cm	NR	1	2	02	62,97

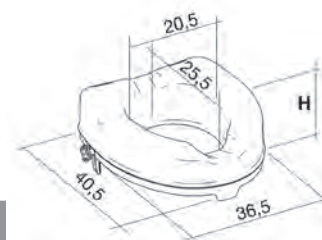

ALZAWATER CON SISTEMA DI BLOCCAGGIO, CON COPERCHIO

In polipropilene. Portata max 250 kg.



	codice	Altezza (H)	UM	min. ord.	conf.	cat.	prezzo (€)
●	3203061	10 cm	NR	1	2	02	82,01

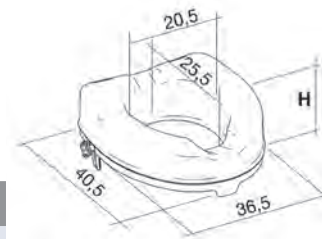

SEGGIOLINO RIBALTABILE PER DOCCIA

In agglomerato, bianco RAL 9010



codice	Portata max (kg)	UM	min. ord. conf.	cat.	prezzo (€)
● 4009023	160	NR	1	03	276,06



SEGGIOLINO RIBALTABILE PER DOCCIA



codice	Portata max (kg)	UM	min. ord. conf.	cat.	prezzo (€)
● 4009007	150	NR	1	03	179,25

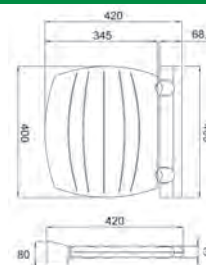

SEGGIOLINO RIBALTABILE PER DOCCIA

In polipropilene.



codice	Portata max (kg)	UM	min. ord. conf.	cat.	prezzo (€)
● 4009024	160	NR	1	03	227,76

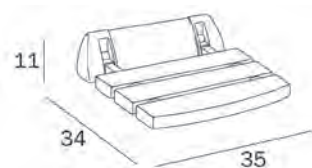

SEGGIOLINO RIBALTABILE PER DOCCIA CON RINFORZO



codice	Portata max (kg)	UM	min. ord. conf.	cat.	prezzo (€)
● 4009008	150	NR	1	03	229,71

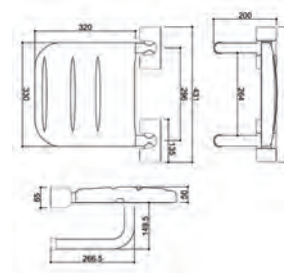

SEGGIOLINO RIBALTABILE PER DOCCIA



codice	Portata max (kg)	UM	min. ord. conf.	cat.	prezzo (€)
● 4009027	125	NR	1	2 03	156,24

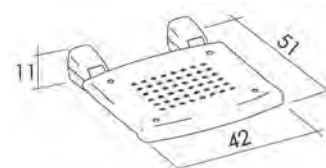

AUSILI BAGNO DISABILI

SEGGIOLINI E SGABELLI

SEGGIOLINO RIBALTABILE PER DOCCIA CON GAMBE



Gambe telescopiche e ribaltabili in alluminio anodizzato. Seduta in tecnopolimero.

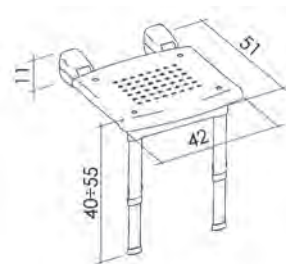

codice	Portata max (kg)	UM	min. ord.	conf.	cat.	prezzo (€)
● 4009019	170	NR	1	2	03	208,65

SEGGIOLINO PER VASCA



Regolabile in larghezza per adattarsi ai diversi tipi di vasca. Struttura in alluminio anodizzato con terminali in gomma, seduta in tecnopolimeri con finitura antiscivolo.

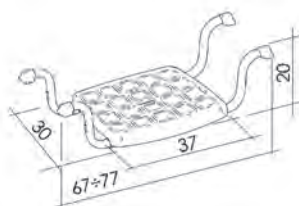

codice	Portata max (kg)	UM	min. ord.	conf.	cat.	prezzo (€)
● 4009026	120	NR	1	2	03	72,36

SEDIA DA DOCCIA CON SCHIENALE



Gambe telescopiche in alluminio anodizzato, altezza regolabile da 39 a 54 cm. Seduta e schienale in polipropilene.

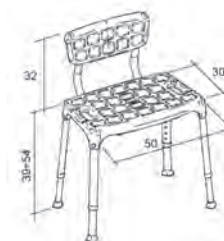

codice	Portata max (kg)	UM	min. ord.	conf.	cat.	prezzo (€)
● 4009017	150	NR	1	2	03	124,77

BRACCIOLI PER SEDIA DA DOCCIA



Finitura antiscivolo. Per sedia da doccia (4009017). Il prezzo è riferito alla coppia.

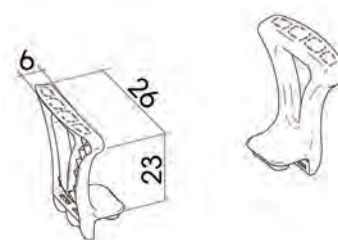

codice	descrizione	UM	min. ord.	conf.	cat.	prezzo (€)
● 4009018	accessorio	NR	1	2	03	40,89

SGABELLO DA BAGNO



Gambe in alluminio anodizzato, seduta in tecnopolimeri con finitura antiscivolo e superficie forata per il deflusso dei liquidi che ne consente l'utilizzo anche sotto la doccia.

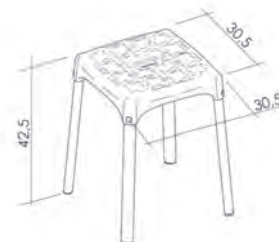

codice	Portata max (kg)	UM	min. ord.	conf.	cat.	prezzo (€)
● 4009029	150	NR	1	2	03	61,86

SGABELLO DA BAGNO REGOLABILE



Gambe in alluminio anodizzato con puntali in gomma antiscivolo. Altezza regolabile da 39 a 54 cm. Seduta in tecnopolimeri con finitura antiscivolo e superficie forata per il deflusso dei liquidi che ne consente l'utilizzo sotto la doccia.

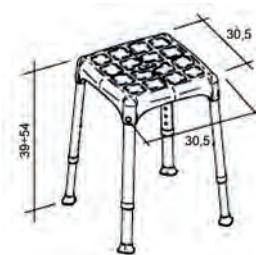

codice	Portata max (kg)	UM	min. ord.	conf.	cat.	prezzo (€)
● 4009016	150	NR	1	2	02	77,25

SGABELLO DA BAGNO



Gambe in alluminio anodizzato con puntali in gomma antiscivolo. Seduta in tecnopolimeri con finitura antiscivolo e superficie forata per il deflusso dei liquidi che ne consente l'utilizzo sotto la doccia.



codice	Portata max (kg)	UM	min. ord.	conf.	cat.	prezzo (€)
● 4009031	150	UM	1	2	03	61,86

SGABELLO DA BAGNO REGOLABILE



Gambe in alluminio anodizzato con puntali in gomma antiscivolo. Altezza regolabile da 39 a 54 cm. Seduta in tecnopolimeri con finitura antiscivolo e superficie forata per il deflusso dei liquidi che ne consente l'utilizzo sotto la doccia.



codice	Portata max (kg)	UM	min. ord.	conf.	cat.	prezzo (€)
● 4009032	150	UM	1	2	03	69,09

AUSILI BAGNO DISABILI

SEDILI UNIVERSALI E ADATTABILI

SEDILE LEGNO MODELLO UNIVERSALE BIANCO EUROPEO



Anima in legno rivestito in poliesteri, completo di viti di fissaggio.

RICAMBI (PAG. 165)
3203092 - Cerniere

codice	cerniere	peso (kg)	UM	min. ord. conf.	cat.	prezzo (€)
● 3203054	cromate	3,20	NR	6	05	67,20

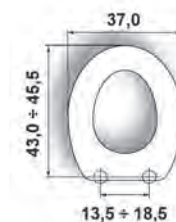

ADATTABILITÀ

MODELLO	CASA CERAMICA	MODELLO	CASA CERAMICA	MODELLO	CASA CERAMICA
AIRONE	TENAX	GARDENA	POZZI GINORI	OPI	INCEA
ALEXANDRA	CESABO	GIOIA	DELTA	ORCHIDEA	EOS (ex SIMCA)
ALFA	SIMAS	GOLIA	JUMBO	PARTENONE	VITRUVIT
AMALFI	HATRIA - SPEA	HOLA	ALTHEA (ex SANITALIA)	PARTENOPEA	VAVID
ANTARES	ALTHEA (EX SANITALIA)	IMPERO	ASTRA	PEGASO	TENAX
ARCOBALENO	POZZI GINORI	IRIS	MICAS	PIEMONTESE DUO	POZZI GINORI
ARENA	FLAMINIA	ISEO	ALFA	PIU'	MICAS
AURA	POZZI GINORI	ISEO	G.S.I. DIVISIONE FACIS	POMPEA	INCEA
AURORA	POZZI GINORI	ISEO MONOB.	ALFA	POMPEI	FLAMINIA
AVENTINO	ISVEA	ITACA	ILCA	PONTI	IDEAL STANDARD
BAIA	HATRIA - SPEA	JUBILEUM	AZZURRA	PONTI ZETA 3164	IDEAL STANDARD
BALZANA	SENESI	LADY	VITRUVIT	PRIMAVERA	IDEAL STANDARD (ex SCALA)
BETA	SIMAS	LAGO MONOBL.	DOLOMITE	RECORD	HIDRA
BRAVA	VINCENTI	LEI NEW	GLOBO	ROMA	HIDRA
BRUNELLO	SENESI	LEI NEW MONOB.	GLOBO	RUGIADA	IDEAL STANDARD (ex SCALA)
CALYPSO	VITRUVIT	LEONESSA	CIERRE SANITARI	SABRINA	FALERI
CANNES	HATRIA - SPEA	LONGA	IDEAL STANDARD (ex SCALA)	SAMBA	DELTA
CARAVAGGIO	DELTA	LUGANO	G.S.I. DIVISIONE FACIS	SELVA	POZZI GINORI
CIMINO	EOS (ex SIMCA)	MAIORCA	EUROPA	SILA	CESAME
CONCHIGLIA	ETRURIA	MENFI	ILCA	SIMPLEX	CESAME
DELTA	DELTA	MICENE	ILCA	SIRIO	ETRURIA
DERBY	GRAVENA	MICHELANGELO	SENESI	SKY	ALTHEA (EX SANITALIA)
DERBY	HATRIA - SPEA	MILANO	VINCENTI	TABOR	POZZI GINORI
DORICA	CESAME	MINERVA	VITRUVIT	TAORMINA	CESAME
ELITE	CESABO	MIRTO	AXA	TOPAZIO	G.S.I. DIVISIONE VENUS
EUROPA	POZZI GINORI	MONACO	HATRIA - SPEA	TORCELLO	POZZI GINORI
FARNESE	VAVID	MONTEZUMA	SIMAS	TRIS	GRAVENA
FAUSTA	SBORDONI	NIZZA	HATRIA - SPEA	TUA	IDEAL STANDARD (ex SCALA)
FLAMINIA	SBORDONI	NOEMI	JUMBO	VEGA	TENAX
FRENTANA	GRAVENA	NORI	FLAMINIA	VERA	GALASSIA
FRIULI	IDEAL STANDARD (ex SCALA)	NOVELLA	FALERI	VIENNA	EUROPA
GAIA	FALERI	OMEGA	JUMBO		

K2 EVO



Universale, avvolgente, termoplastico in resina infrangibile.

codice	sigla	cerniere	peso (kg)	UM	min. ord. conf.	cat.	prezzo (€)
● 3203051	1109	plastica	1,20	NR	1 9	06	24,43

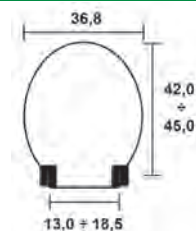

STAR



In resina termoindurente, antigraffio. Cerniere inox regolabili, funzione sgancio rapido.

codice	cerniere	peso (kg)	UM	min. ord. conf.	cat.	prezzo (€)
● 3203067	inox	2,76	NR	5	03	49,77



TESI BIANCO EURO



Anima in legno rivestito in poliestere, completo di viti di fissaggio

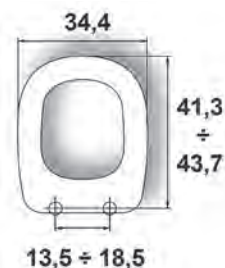

RICAMBI (PAG. 165)
3203092 - Cerniere

codice	sigla	cerniere	peso (kg)	UM	min. ord.	conf.	cat.	prezzo (€)
● 3203033	M0200A1/01	cromate	3,0	NR	1	6	05	69,22

ADATTABILITÀ

MODELLO	CASA CERAMICA
CURVA	VINCENTI
NUBE	INCEA
NUBE MONO	INCEA
ORIENT	RAK CERAMICS
PIENZA	SENESE
TESI	IDEAL STANDARD
TESI NEW SOSPESO	IDEAL STANDARD

CONCA BIANCO EURO



Anima in legno rivestito in poliestere, completo di viti di fissaggio

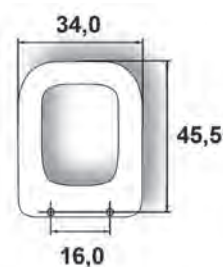

codice	sigla	cerniere	peso (kg)	UM	min. ord.	conf.	cat.	prezzo (€)
● 3203034	M0500F2/01	cromate	3,0	NR	1	6	05	69,22

ADATTABILITÀ

MODELLO	CASA CERAMICA
C-0	ISVEA
CONCA	IDEAL STANDARD
CONNYY	GRAVENA
CORTINA	CIERRE SANITARI
DUCCIO	SENESE
MAXI JOLLY	SCIC
MEDINA	FALERI
PRESTIGE	CESABO
SVEDA	ALTHEA (ex Sanitalia)
VERSILIA	VINCENTI

RICAMBI

KIT CERNIERA



Compatibilità
3203054 - Universale
3203033 - Tesi
3203058 - Tipo casual

codice	sigla	UM	min. ord.	conf.	cat.	prezzo (€)
● 3203092	CWCA01	NR	1	1	05	38,40

CASSETTE DI SCARICO

CASSETTE ESTERNE

Scocca in ABS con trattamento anti invecchiamento. Coibentazione anticondensa ed insonorizzante. Galleggiante a scatola da 3/8" compatto, rapido e silenzioso.

TURBINE 2



Installazione a zaino o media altezza, capacità 7,5 lt con doppio tasto per scarico parziale da 1 a 4,5 lt. Completa di rubinetto galleggiante Nanotek per allacciamento idrico destro, sinistro o centrale posteriore. Tubo di scarico e kit di fissaggio compresi.

RICAMBI (PAG. 169, 172)

- 3302017 - Rubinetto galleggiante Nanotek
- 3302117 - Meccanismo completo
- 3302119 - Gruppo ponte con leve

codice	UM	min. ord. conf.	cat.	prezzo (€)
● 3301001	NR	5	01	66,30

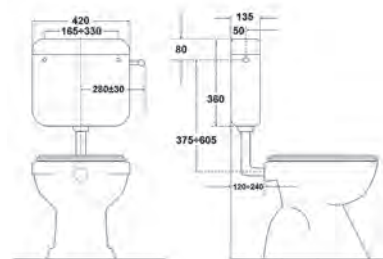

ZEUS 1



Ultrapiatte, installazione a zaino o media altezza, capacità 6 lt con un tasto start/stop. Completa di rubinetto per allacciamento idrico destro o sinistro o centrale posteriore. Tubo di scarico e kit di fissaggio compresi.

RICAMBI (PAG. 172)

- 3302126 - Meccanismo completo

codice	UM	min. ord. conf.	cat.	prezzo (€)
● 3301034	NR	1	01	55,07

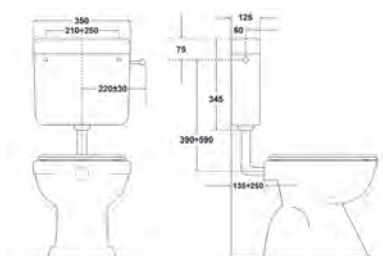

TURBINE CON PREDISPOSIZIONE PNEUMATICA



Predisposta per comando pneumatico a scelta, installazione alta o a zaino, adatta a bagni per disabili. Capacità 7,5 lt, completa di rubinetto per allacciamento idrico destro, sinistro o centrale posteriore. Tubo di scarico e kit di fissaggio compresi.

ACCESSORI E RICAMBI (PAG. 168, 172)

- 3302301 - Pulsante esterno
- 3302302 - Pulsante incasso
- 3302128 - Meccanismo completo

codice	UM	min. ord. conf.	cat.	prezzo (€)
● 3301012	NR	1	01	68,61

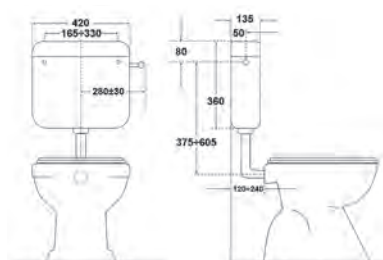

ALFA ALTA



Installazione in posizione alta, capacità 8,5 lt con comando a leva con cordella. Completa di rubinetto per allacciamento idrico destro o sinistro.

codice	sigla	descrizione	UM	min. ord. conf.	cat.	prezzo (€)
● 3301032	1041S	con coperchio	NR	1	02	42,96

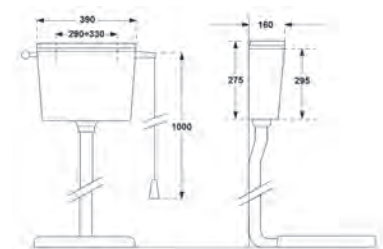

ANGOLO



Installazione a zaino in angolo, capacità 8,5 lt con un tasto start/stop. Possibilità di allacciamento idrico destro o sinistro. Tubo di scarico e kit di fissaggio compresi.

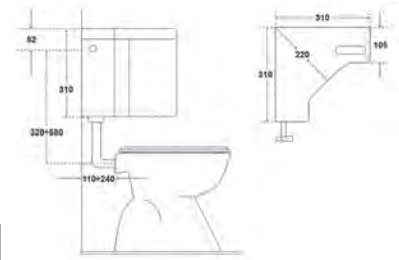

codice	sigla	descrizione	UM	min. ord. conf.	cat.	prezzo (€)
● 3301041	1051	con rubinetto	NR	1	02	88,77

SLIM



Superpiatta. Installazione a zaino, capacità 9 litri con tasto start/stop. Coibentazione anticondensa. Completa di rubinetto per allacciamento destro o sinistro o centrale posteriore.

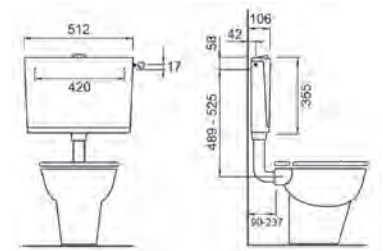

RICAMBI (PAG. 172)
3302129 - Meccanismo completo

codice	UM	min. ord.	conf.	cat.	prezzo (€)
● 3301080	NR	1	28	02	115,94

CASSETTE INCASSO

GROHE CASSETTA INCASSO spessore mm. 80



Senza piastra di azionamento.

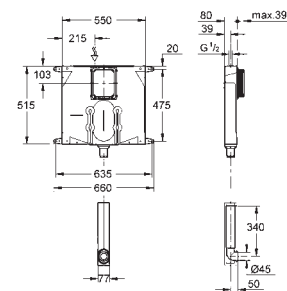

codice	UM	min. ord.	conf.	cat.	prezzo (€)
● 38863000	NR	1	20	17	182,31

CASSETTE DI SCARICO

CASSETTE INCASSO

GROHE UNISSET TELAIO CON CASSETTA PER WC SOSPESO



Senza piastra di azionamento.

codice	UM	min. ord.	conf.	cat.	prezzo (€)
● 38729000	NR	1	20	17	293,02

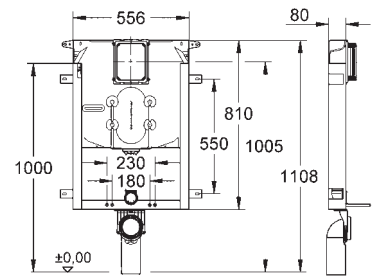

STAFFA BIDET SOSPESO MOD. COMBI



Compreso raccorderia di fissaggio.

codice	interasse (mm)	UM	min. ord. conf.	cat.	prezzo (€)
● 5850031	180-230	NR	1	09	118,24

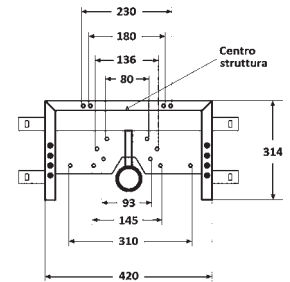

ACCESSORI E RICAMBI CASSETTE

GROHE PIASTRA SKATE COSMO



codice	finitura	UM	min. ord. conf.	cat.	prezzo (€)
● 38732SH0	bianca	NR	1	11	96,25
● 38732000	cromo	NR	1	11	111,77

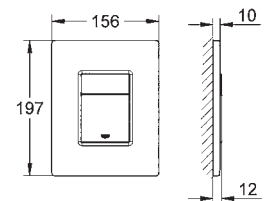

GROHE PIASTRA PER CASSETTA 37594

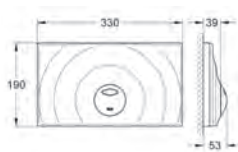

codice	finitura	UM	min. ord. conf.	cat.	prezzo (€)
● 37859SH0	bianca	NR	1	10	81,98

GROHE PIASTRA AZIONAMENTO PER CASSETTA 37051

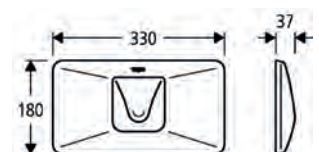

codice	finitura	UM	min. ord. conf.	cat.	prezzo (€)
● 37054SH0	bianca	NR	1	10	85,65

PULSANTE ESTERNO BIANCO

Completo di tubetto e canalina.



codice	sigla	UM	min. ord. conf.	cat.	prezzo (€)
● 3302301	PE	NR	1	06	44,97

PULSANTE INCASSO BIANCO

Completo di tubetto e guaina.



codice	sigla	UM	min. ord. conf.	cat.	prezzo (€)
● 3302302	PI	NR	1	06	37,50

RUBINETTO GALLEGGIANTE MAGNETIC UNIVERSALE

Galleggiante insonorizzato conforme DIN 4109 a funzionamento magnetico, con regolazione livello acqua, vite di regolazione reversibile, filtro anti impurità. Funzionamento da 0,4 a 10 bar.

APPLICAZIONI: per cassette incasso di nuova generazione e per cassette esterne in plastica e ceramica.

DOTAZIONE: codolo ottone 3/8" nichelato di 40 mm.; codolo 3/8" plastica di 30 mm.; dado e rondella plastica da 3/8"



codice	sigla	UM	min. ord. conf.	cat.	prezzo (€)
● 3302010	CMAGNCER	NR	25	06	28,51

RUBINETTO GALLEGGIANTE MAGIK INCASSO

Per qualsiasi tipo e marca di cassetta wc, sia incasso che esterna.

Galleggiante insonorizzato conforme DIN 4109 a funzionamento magnetico, con regolazione livello acqua, filtro anti impurità, distanziale anticollisione

Funzionamento da 0,2 a 10 bar.



codice	sigla	UM	min. ord. conf.	cat.	prezzo (€)
● 3302016	CMAGIK00	NR	1 25	06	53,28

RUBINETTO GALLEGGIANTE FLUIDMASTER ATTACCO LATERALE

Con **codolo in ottone**. Per qualsiasi tipo e marca di cassetta wc, sia incasso che esterna o a zaino. Adatto anche per le cassette ultrapiatte. Silenzioso, compatto, resistente alla corrosione con filtro anti impurità. Chiusura istantanea del flusso a livello desiderato, con regolazione semplice e invariabile con la pressione.

Adattatore universale incluso.



codice	sigla	UM	min. ord. conf.	cat.	prezzo (€)
● 3302006	747E-036-P20	NR	20	15	28,49

RUBINETTO GALLEGGIANTE CONTROPRESSIONE NANOTEK

Universale per cassette esterne e incasso.

Fornito con due adattatori che permettono di installare il galleggiante su cassette di altri produttori.

Dotato di silenziatore acustico per ridurre l'impatto sonoro, filtro anti-impurità ispezionabile.



codice	sigla	UM	min. ord. conf.	cat.	prezzo (€)
● 3302017	1513IT	NR	1 14	15	22,25

RUBINETTO GALLEGGIANTE FLUIDMASTER ATTACCO DAL BASSO

Con **codolo in ottone**. Per qualsiasi tipo e marca di cassetta wc esterna ed in ceramica, con attacco alla rete idrica in basso. Silenzioso, compatto, resistente alla corrosione, con filtro anti impurità. Regolazione telescopica dell'altezza. Chiusura istantanea del flusso a livello desiderato, con regolazione semplice e invariabile con la pressione.



codice	sigla	UM	min. ord. conf.	cat.	prezzo (€)
● 3302007	400E-025-P25	NR	1 25	15	33,37

BATTERIA A CAVO

Batteria a cavo 2 scarichi, per cassette in ceramica.

Pulsante compatibile con fori D. 40 e D. 20



codice	sigla	UM	min. ord. conf.	cat.	prezzo (€)
● 3302411	1402CSG	NR	1	06	41,00

BATTERIA PNEUMATICA

Batteria pneumatica 1 scarico, per cassette in ceramica.

Pulsante compatibile con fori D. 40 e D. 20



codice	sigla	UM	min. ord. conf.	cat.	prezzo (€)
● 3302410	1402ASG	NR	1	06	27,99

CASSETTE DI SCARICO

ACCESSORI E RICAMBI CASSETTE

TUBO SCARICO CASSETTA ZAINO 600X220 mm

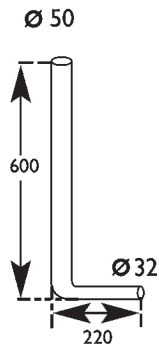

●	codice	sigla	UM	min. ord.	conf.	cat.	prezzo (€)
	3302106	1502	NR	1	10	06	11,72

TUBO SCARICO CASSETTA ZAINO 1000X220 mm

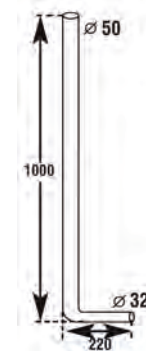

●	codice	sigla	UM	min. ord.	conf.	cat.	prezzo (€)
	3302103	1503	NR	1	18	06	16,76

TUBO SCARICO CASSETTA ZAINO 1100 x 280 mm REGOLABILE

Due pezzi.
Completo di manicotto e
fissaggi

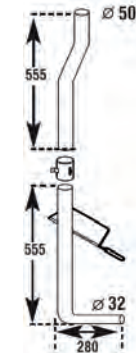

●	codice	sigla	uscita Ø	UM	min. ord.	conf.	cat.	prezzo (€)
	3302104	1503A	32	NR	1	20	06	29,98

TUBO SCARICO CASSETTA ZAINO 800 x 260 mm

Sagomato

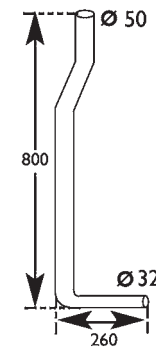

●	codice	sigla	UM	min. ord.	conf.	cat.	prezzo (€)
	3302107	1508	NR	1	20	06	15,08

TUBO SCARICO CASSETTA ALTA

Tubo componibile 2 pezzi.

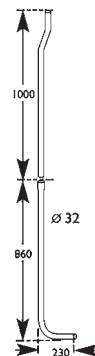

●	codice	sigla	UM	min. ord.	conf.	cat.	prezzo (€)
	3302101	1500A	NR	1	15	06	10,20

KIT TUBO SCARICO CASSETTA ALTA, CROMATO

Tubo componibile 3 pezzi
D.30 mm, in ottone cromato.
Compreso kit di fissaggio



●	codice	UM	min. ord. conf.	cat.	prezzo (€)
	3302112	NR	1	06	220,18

TUBO DI SCARICO CASSETTA ZAINO

620x330 mm
con morsetto D.50x44

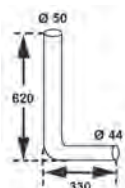

●	codice	sigla	UM	min. ord. conf.	cat.	prezzo (€)
	3302108	1501BLACC	NR	1	06	13,40

SPANDIACQUA UNIVERSALE PER TURCA

Per tubo D.32 mm



●	codice	sigla	UM	min. ord. conf.	cat.	prezzo (€)
	3302109	1519	NR	1	06	5,01

CANOTTO TELESCOPICO

Completo di rosone e morsetto per wc.

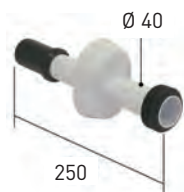

codice	UM	min. ord.	conf.	cat.	prezzo (€)
● 3302205	NR	1	50	06	10,58

CANOTTO DRITTO

Completo di rosone e morsetto per wc



codice	sigla	UM	min. ord.	conf.	cat.	prezzo (€)
● 3302204	2178.307.6.	NR	1	30	06	11,81

CANOTTO ECCENTRICO

Completo di rosone e morsetto per wc



codice	sigla	UM	min. ord. conf.	cat.	prezzo (€)
● 3302203	1506B	NR	1	06	9,76

GROHE CANOTTO PER CASSETTA



codice	UM	min. ord.	conf.	cat.	prezzo (€)
● 37103SH0	NR	1	40	10	16,13

CURVETTA IN RAME PER GALLEGGIANTI

Tubo D. 10 mm, raccordi da 3/8" con guarnizioni. Per adattare i galleggianti ai diversi tipi di cassette ad incasso.



codice	sigla	UM	min. ord. conf.	cat.	prezzo (€)
● 3302013	BG091600	NR	1	06	10,40

RUBINETTO MASCHIO PER CASSETTA WC

Chiusura a vitone con codolo e calotta girevole



codice	sigla	attacco Ø	UM	min. ord.	conf.	cat.	prezzo (€)
● 2733002	0500C300CR	3/8"x3/8"	NR	1	50	06	10,94
● 2733001	0500C400CR	1/2"x3/8"	NR	1	50	06	11,34

RUBINETTO FEMMINA PER CASSETTA WC

Chiusura a vitone con codolo e calotta girevole



codice	sigla	attacco Ø	UM	min. ord.	conf.	cat.	prezzo (€)
● 2733000	0509C300CR	3/8"x3/8"	NR	1	50	06	9,29

RUBINETTO MASCHIO PER CASSETTA WC CON TUBO

Chiusura a vitone con tubetto in rame cromato D.10



codice	sigla	attacco Ø	UM	min. ord.	conf.	cat.	prezzo (€)
● 2733003	05050300CR	3/8"x3/8"	NR	1	25	06	13,39
● 2733004	05050400CR	1/2"x3/8"	NR	1	25	06	13,61

RUBINETTO MASCHIO PER CASSETTA WC CON TUBI

Chiusura a vitone, con tubetti in rame cromato D.10 lunghi 15 cm



codice	sigla	attacco Ø	UM	min. ord.	conf.	cat.	prezzo (€)
● 2733005	05070300CR	3/8"x3/8"	NR	1	20	06	19,98

CASSETTE DI SCARICO

ACCESSORI E RICAMBI CASSETTE

TURBINE 2 MECCANISMO COMPLETO



codice	sigla	UM	min. ord. conf.	cat.	prezzo (€)
● 3302117	1400C	NR	1	06	18,47

TURBINE 2 GRUPPO PONTE CON LEVE



codice	sigla	UM	min. ord. conf.	cat.	prezzo (€)
● 3302119	1531R4	NR	1	06	14,78

ZEUS/NETTUNO 1 MECCANISMO COMPLETO



codice	sigla	UM	min. ord. conf.	cat.	prezzo (€)
● 3302126	1400B	NR	1	06	16,61

TURBINE 1 GRUPPO PONTE CON LEVE



codice	sigla	UM	min. ord. conf.	cat.	prezzo (€)
● 3302128	1531R3	NR	1	06	13,85

SLIM MECCANISMO COMPLETO



codice	UM	min. ord. conf.	cat.	prezzo (€)
● 3302129	NR	1	02	38,73

GUARNIZIONE DI TENUTA MECCANISMO DI SCARICO

Confezione da 10 Pz.

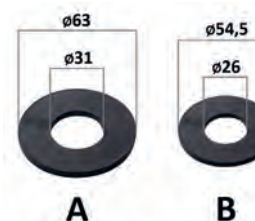

codice	sigla	modello	UM	min. ord. conf.	cat.	prezzo (€)
● 3302201	1540-10	A	CF	1	06	18,47
● 3302202	1540V-10	B	CF	1	06	18,47

RICAMBI GROHE

VALVOLA CARICO UNIVERSALE DA 3/8"

Per cassette alte e basse, in ceramica o plastica, con cappuccio diaframma di strozzamento e compensatore di spostamento.



codice	UM	min. ord. conf.	cat.	prezzo (€)
● 37092000	NR	1	10	70,67

VALVOLA DI CARICO



codice	UM	min. ord. conf.	cat.	prezzo (€)
● 43991000	NR	1	10	72,55

VALVOLA SCARICO AV1



codice	UM	min. ord. conf.	cat.	prezzo (€)
● 42320000	NR	1	10	69,89

VALVOLA DI SCARICO PER CASSETTE 37594



codice	UM	min. ord. conf.	cat.	prezzo (€)
● 42253000	NR	1	10	122,02

VALVOLA DI SCARICO CON INTERRUZIONE



codice	UM	min. ord. conf.	cat.	prezzo (€)
● 43992000	NR	1	10	140,73

VALVOLA SCARICO COMPLETA



codice	UM	min. ord. conf.	cat.	prezzo (€)
● 42961000	NR	1	10	52,14

PISTONE VALVOLA SCARICO PER CASSETTA ESTERNA



codice	UM	min. ord. conf.	cat.	prezzo (€)
● 43544000	NR	1	10	23,38

VALVOLA SCARICO PER CASSETTA ESTERNA



codice	UM	min. ord. conf.	cat.	prezzo (€)
● 43486000	NR	1	10	93,02

MEMBRANA CARICO



codice	UM	min. ord. conf.	cat.	prezzo (€)
● 43733000	NR	1	10	7,45

SFERA VALVOLA SCARICO PER CASSETTA 37051



codice	UM	min. ord. conf.	cat.	prezzo (€)
● 43917000	NR	1	10	37,46

SCALETTA AZIONAMENTO



codice	UM	min. ord. conf.	cat.	prezzo (€)
● 43546000	NR	1	10	7,28

TRAVERSA



codice	UM	min. ord. conf.	cat.	prezzo (€)
● 42962000	NR	1	10	27,50

PIASTRA DI PROTEZIONE PER CASSETTA 37643



codice	UM	min. ord. conf.	cat.	prezzo (€)
● 43966000	NR	1	10	87,58

LEVA COMPLETA PER CASSETTA 37643



codice	UM	min. ord. conf.	cat.	prezzo (€)
● 43985000	NR	1	10	18,42

GUARNIZIONE















codice	UM	min. ord. conf.	cat.	prezzo (€)
● 42310000	NR	1	10	10,05

LAVATOI

LAVATOI CON MOBILE

TIPI DI VASCHE

Tipo 1	Tipo 2	Tipo 3	Tipo 4	Tipo 5	Tipo 6	Tipo 7
						
Prof. 23,5	Prof. 22,5	Prof. 23,5	Prof. 21,5	Prof. 23,5	Prof. 23,5	Prof. 28,5
Tipo 8 / BI-VASCA	Tipo 9	Tipo 10	Tipo 11	Tipo 12	Tipo 13	
						
Prof. 19,5 - 22,5	Prof. 26	VASCA A DESTRA Prof. 22,5	VASCA A SINISTRA Prof. 22,5	VASCA A DESTRA Prof. 22,5	VASCA A SINISTRA Prof. 22,5	

Prof.: profondità della vasca in corrispondenza della piletta.

FUTURA PER INTERNO



Caratteristiche:

- mobile in bilaminato idrofugo, sportelli lucidi con angoli arrotondati, maniglie nichel spazzolato lucido
- vasca in resina, forabile per installazione del rubinetto
- cerniere ante chiusura rallentata e vassoio salvafondo in alluminio
- asse in pino verniciato e sifone autopulente con attacco lavatrice, particolari inox
- zoccolo in PVC ricoperto con lamina in alluminio estraibile per una facile pulizia sotto il mobile (escluso i coprilavatrice)
- piedini regolabili in altezza fino a 15 mm.

La versione a 1 anta prevede le cerniere a destra (su richiesta si possono avere a sinistra).

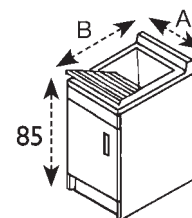

codice	sigla	AxB (cm)	tipo vasca	N° ante	UM	min. ord. conf.	cat.	prezzo (€)
3402001	2006FB	45x50	1	1	NR	1	03	297,96
3402005	2005FB	45x60	2	1	NR	1	03	370,19
3402002	2003FB	50x50	3	1	NR	1	03	306,97
3402006	2009FB	60x45	4	2	NR	1	03	403,29
3402003	2002FB	60x50	5	2	NR	1	03	350,63
3402004	2007FB	60x60	6	2	NR	1	03	371,68
3402008	2013FB	75x60	7	2	NR	1	03	526,68
3402007	2012FB	75x60	8	2	NR	1	03	510,11
3402009	2010FB	80x50	9	2	NR	1	03	505,63

FUTURA COPRILAVATRICE PER INTERNO



Caratteristiche:

- mobile in bilaminato idrofugo, sportelli lucidi con angoli arrotondati, maniglie nichel spazzolato lucido
- vasca in resina, forabile per installazione del rubinetto
- cerniere ante chiusura rallentata e vassoio salvafondo in alluminio
- asse in pino verniciato e sifone autopulente con attacco lavatrice, particolari inox
- zoccolo in PVC ricoperto con lamina in alluminio estraibile per una facile pulizia sotto il mobile (escluso i coprilavatrice)
- piedini regolabili in altezza fino a 15 mm.

La versione a 1 anta prevede le cerniere a destra (su richiesta si possono avere a sinistra).

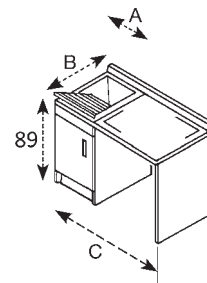

Versione SX

codice	sigla	AxBxC (cm)	tipo vasca	N° ante	UM	min. ord. conf.	cat.	prezzo (€)
3402010	2008FBDX	45x60x109	10	1	NR	1	03	406,30
3402012	2008FBSX	45x60x109	11	1	NR	1	03	406,30
3402011	2800FBDX	60x60x124	12	2	NR	1	03	571,82
3402013	2800FBSX	60x60x124	13	2	NR	1	03	571,82

PRATIKA PER INTERNO

**Caratteristiche:**

- mobile in bilaminato idrofugo, sportelli con angoli squadrati, maniglie e piedini satinati
- vasca in resina, forabile per l'installazione del rubinetto
- asse in resina plastica, su richiesta asse in legno verniciato
- sifone autopulente con attacco lavatrice e troppo pieno

La versione a 1 anta prevede le cerniere a destra (su richiesta si possono avere a sinistra).

codice	sigla	AxB (cm)	tipo vasca	N° ante	UM	min. ord. conf.	cat.	prezzo (€)
3403001	3006SB	45x50	1	1	NR	1	03	242,09
3403005	3005SB	45x60	2	1	NR	1	03	312,55
3403002	3003SB	50x50	3	1	NR	1	03	245,15
3403006	3009SB	60x45	4	2	NR	1	03	324,81
3403003	3002SB	60x50	5	2	NR	1	03	271,19
3403004	3007SB	60x60	6	2	NR	1	03	291,11
3403007	3013SB	75x60	7	2	NR	1	03	438,21
3403009	3012SB	75x60	8	2	NR	1	03	419,80
3403008	3010SB	80x50	9	2	NR	1	03	436,67

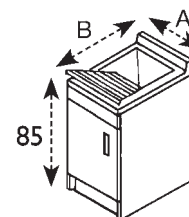

ROCKY PER INTERNO

**Caratteristiche:**

- mobile in bilaminato idrofugo, sportelli con angoli squadrati, maniglie e piedini satinati
- vasca in resina, forabile per l'installazione del rubinetto
- asse in resina plastica, su richiesta asse in legno verniciato
- sifone autopulente con attacco lavatrice e troppo pieno

La versione a 1 anta prevede le cerniere a destra (su richiesta si possono avere a sinistra).

codice	sigla	AxBxC (cm)	tipo vasca	N° ante	UM	min. ord. conf.	cat.	prezzo (€)
3407061	6006SK	45x50	1	1	NR	1	03	205,30
3407062	6003SK	50x50	3	1	NR	1	03	212,96
3407063	6002SK	60x50	5	2	NR	1	03	232,88
3407064	6007SK	60x60	6	2	NR	1	03	254,35

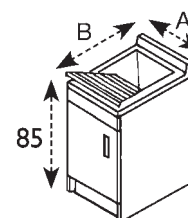

QUEEN VASCA IN CERAMICA PER INTERNO

**Caratteristiche:**

- mobile in bilaminato idrofugo, sportelli con angoli squadrati, maniglie satinati
- cerniere ante a chiusura rallentata e vassoio salva-fondo in alluminio
- vasca in ceramica, con foro per l'installazione del rubinetto
- senza asse, su richiesta asse in legno verniciato
- sifone autopulente con pilettoni 3"1/2 con accessori inox
- piedini regolabili in altezza fino a 15 mm.



codice	sigla	AxB (cm)	N° ante	UM	min. ord. conf.	cat.	prezzo (€)
3405030	2002BCER	60x50	2	NR	1	03	597,54

LAVATOI

LAVATOI CON MOBILE

JUNIOR IN KIT (SMONTATO) PER ESTERNO



Caratteristiche:

- mobile interamente in PVC resistente all'umidità, adatto per esterni o luoghi umidi (garage, cantine, giardini, terrazzi)
- kit automontante, montaggio senza l'ausilio di attrezzi, in quanto senza viti
- maniglie cromate
- vasca in resina, forabile per installazione del rubinetto
- asse in resina
- sifone autopulente con attacco lavatrice
- piedini regolabili in altezza fino a 15 mm.

La versione a 1 anta prevede le cerniere a destra (su richiesta si possono avere a sinistra).

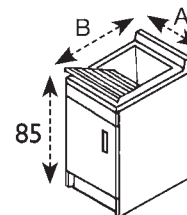

codice	sigla	AxB (cm)	tipo vasca	N° ante	UM	min. ord. conf.	cat.	prezzo (€)
3407005	9006K	45x50	1	1	NR	1	03	170,08
3407006	9003K	50x50	3	1	NR	1	03	173,14
3407007	9002K	60x50	5	2	NR	1	03	186,92
3407008	9007K	60x60	6	2	NR	1	03	203,78

JUNIOR PER ESTERNO



Caratteristiche:

- mobile interamente in PVC con trattamento anti-invecchiamento resistente all'umidità, adatto per esterni o luoghi umidi (garage, cantine, giardini, terrazzi)
- sportelli con chiusura a battente calamitata
- maniglie cromate
- vasca in resina, forabile per installazione del rubinetto
- asse in resina, su richiesta asse in legno verniciato
- sifone autopulente con troppo pieno
- piedini regolabili in altezza fino a 15 mm.

La versione a 1 anta prevede le cerniere a destra (su richiesta si possono avere a sinistra).

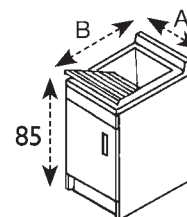

codice	sigla	AxB (cm)	tipo vasca	N° ante	UM	min. ord. conf.	cat.	prezzo (€)
3405001	9006	45x50	1	1	NR	1	03	223,71
3405002	9003	50x50	3	1	NR	1	03	225,22
3405003	9002	60x50	5	2	NR	1	03	239,03
3405004	9007	60x60	6	2	NR	1	03	249,75

MOBILETTO SOTTOCERAMICA PER INTERNO

Per lavatoi di ceramica in appoggio, compatibile con modello Messico (Dolomite) e Iseo (Pozzi Ginori).

Caratteristiche:

- mobile in bilaminato
- sportelli con angoli squadrati
- due ante con maniglie cromate
- piedini cromati regolabili in altezza 15mm

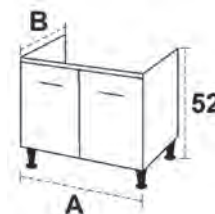

codice	sigla	AxB (cm)	compatibilità	UM	min. ord. conf.	cat.	prezzo (€)
3405021	2016	47x32	Messico 60	NR	1	03	137,89
3405022	2017	60x42	Messico 75 - Iseo 75	NR	1	03	160,88

PILOZZI



GRIGIO

Caratteristiche:

- in polipropilene lucido sia internamente che esternamente
- ideale per esterni
- resistente agli acidi, ai prodotti chimici e agli agenti atmosferici
- completo di sifone e piletta con troppopieno
- fissaggi a corredo

codice	sigla	AxBxC (cm)	colore	UM	min. ord. conf.	cat.	prezzo (€)
3408001	2051	50x34x21	bianco	NR	1	03	47,92
3408003	2051B	59x34x21	bianco	NR	1	03	51,89
3408011	2051G	50x34x21	grigio	NR	1	03	55,89
3408013	2051BG	59x34x21	grigio	NR	1	03	59,89

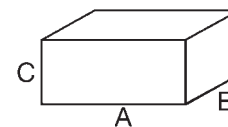

Con portasapone e predisposizione per rubinetto e dosatore



GRIGIO

codice	sigla	AxBxC (cm)	colore	UM	min. ord. conf.	cat.	prezzo (€)
3408002	2051A	55x34x21	bianco	NR	1	03	49,92
3408012	2051AG	55x34x21	grigio	NR	1	03	57,89

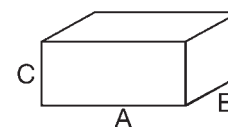

ACCESSORI LAVATOI

ASSE IN LEGNO

Pino verniciato

NOVITÀ!



A



B



C

codice	sigla	dimensioni (cm)	compatibilità tipo vasca	foto	UM	min. ord. conf.	cat.	prezzo (€)
3405050	2040	38,4x34,7	1-2-8-10-11	A	NR	1	03	58,48
3405053	2038	41,4x35,0	3	A	NR	1	03	60,02
3405055	2042	53,5x34,8	4-5-6-12-13	B	NR	1	03	61,56
3405056	2056	66,3x35,9	7	C	NR	1	03	64,64
3405058	2054	71,8x34,9	9	C	NR	1	03	64,64

ASSE IN RESINA SPECIALE

NOVITÀ!

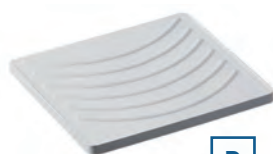

D

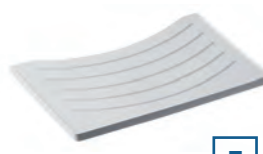

E

codice	sigla	dimensioni (cm)	compatibilità tipo vasca	foto	UM	min. ord. conf.	cat.	prezzo (€)
3405051	2040CR	38,4x35,0	1-2-8-10-11	D	NR	1	03	30,78
3405052	2038CR	40,8x35,0	3	D	NR	1	03	32,32
3405054	2042CR	53,5x35,5	4-5-6-12-13	E	NR	1	03	38,48

CATALOGO
LISTINO N° 8

COMPLEMENTI SANITARI

COMPLEMENTI
SANITARI

SIFONAME	180
RUBINETTERIA SOTTOLAVABO, LAVATRICE E VARIA	200
FLESSIBILI ACQUA E ANTIVIBRANTI	207
SISTEMI DI FISSAGGIO	210
TRITURATORI E POMPE SOLLEVAMENTO	211

SIFONAME

SIFONI INOX 316

SIFONE A VISTA



NOVITÀ!

codice	Ø	tubo uscita (lungh. mm)	UM	min. ord.	conf.	cat.	prezzo (€)
● 2601030	1"1/4x32	300	NR	1	1	05	165,76

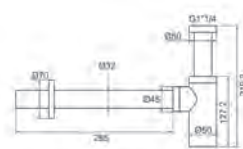

SIFONI A VISTA IN OTTONE

Sifoni per lavabi a vista in ottone, design minimale e finiture accurate. Speciali raccordi filettati (anelli cilindrici) che sostituiscono i dadi tradizionali. Rosone piatto. Completamente ispezionabili per la pulizia periodica.

SIFONE A VISTA TAPPO A VISTA



codice	finitura	Ø	tubo uscita (lungh. mm)	UM	min. ord.	conf.	cat.	prezzo (€)
● 2601017	cromo	1"1/4x32	300	NR	1	10	05	92,16
● 2601917	nero opaco	1"1/4x32	300	NR	1	10	05	202,88

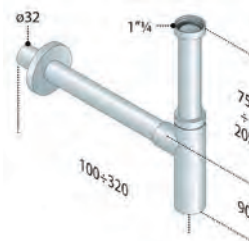

SIFONE A VISTA MINIMAL



codice	finitura	Ø	tubo uscita (lungh. mm)	UM	min. ord.	conf.	cat.	prezzo (€)
● 2601018	cromo	1"1/4x32	250	NR	1	10	05	54,98
● 2601918	nero opaco	1"1/4x32	250	NR	1	10	05	114,24
● 2601718	bianco opaco	1"1/4x32	250	NR	1	10	05	114,24
● 2601818	simil acciaio	1"1/4x32	250	NR	1	10	05	204,64

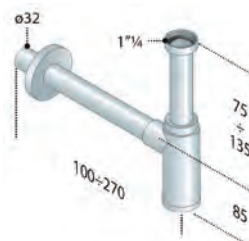

SIFONE A VISTA INGOMBRO RIDOTTO



codice	Ø	tubo uscita (lungh. mm)	UM	min. ord.	conf.	cat.	prezzo (€)
● 2601016	1"1/4x32	300	NR	1	10	05	101,54

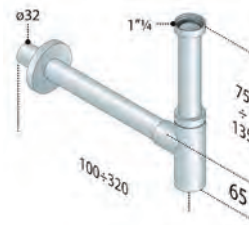

SIFONE A VISTA SALVASPAZIO



codice	Ø	tubo uscita (lungh. mm)	UM	min. ord.	conf.	cat.	prezzo (€)
● 2601013	1"1/4x32	100	NR	1	8	05	126,18

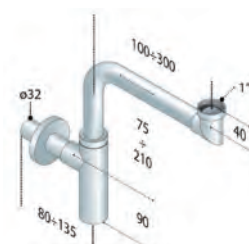

SIFONE A "S"

Da pressofusione. Rosone inox.



	codice	Ø	tubo uscita (lungh. mm)	UM	min. ord.	conf.	cat.	prezzo (€)
●	2101001	1"1/4x32	250	NR	30	30	05	22,69
●	2101002	1"x26	250	NR	1	30	05	19,65

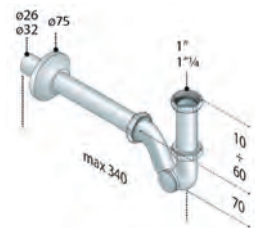

SIFONE A "S" PESANTE

Da fusione in conchiglia. Rosone in ottone.



	codice	Ø	tubo uscita (lungh. mm)	UM	min. ord.	conf.	cat.	prezzo (€)
●	2101011	1"1/4x32	250	NR	10	10	05	29,54

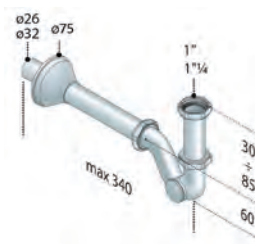

SIFONE A "U"

Da pressofusione. Rosone inox.



	codice	Ø	tubo uscita (lungh. mm)	UM	min. ord.	conf.	cat.	prezzo (€)
●	2102001	1"1/4x32	250	NR	30	30	05	22,69
●	2102002	1"x26	250	NR	1	30	05	19,65

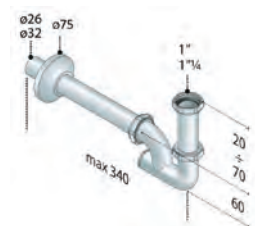

SIFONE A "U" PESANTE

Da fusione in conchiglia. Rosone in ottone.



	codice	Ø	tubo uscita (lungh. mm)	UM	min. ord.	conf.	cat.	prezzo (€)
●	2102101	1"1/4x32	250	NR	10	10	05	29,54

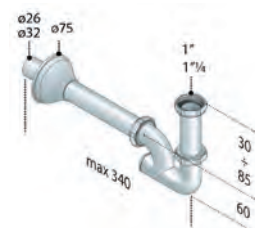

SIFONE BOTTIGLIA

Da pressofusione. Rosone inox.



	codice	Ø	tubo uscita (lungh. mm)	UM	min. ord.	conf.	cat.	prezzo (€)
●	2103001	1"1/4x32	250	NR	1	30	05	22,69
●	2103002	1"x26	250	NR	1	30	05	19,65

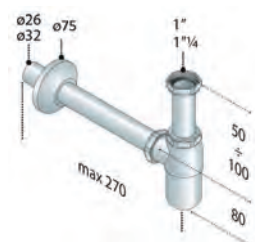

SIFONAME

SIFONI OTTONE LAVABO BIDET

SIFONE BOTTIGLIA PESANTE

Da fusione in conchiglia. Rosone in ottone.



codice	∅	tubo uscita (lung. mm)	UM	min. ord.	conf.	cat.	prezzo (€)
● 2103003	1"1/4x32	250	NR	1	10	05	29,54

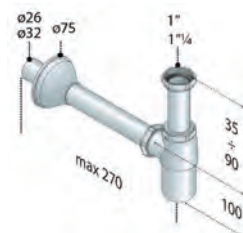

SIFONE LAVABO/BIDET INGOMBRO RIDOTTO



codice	sigla	∅	tubo uscita (lung. mm)	UM	min. ord.	conf.	cat.	prezzo (€)
● 2601006	-522.423.5.	1"1/4x32	250	NR	1	10	05	44,54

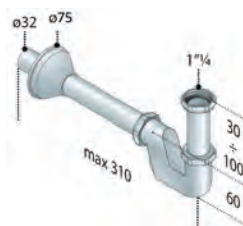

SIFONE TUBOLARE LAVABO/BIDET



codice	∅	tubo uscita (lung. mm)	UM	min. ord.	conf.	cat.	prezzo (€)
● 2601009	1"1/4x32	220	NR	1	15	05	23,39

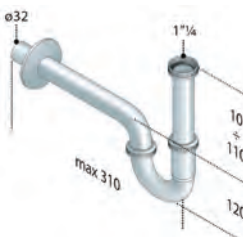

Sifoni in ABS cromato alla vista del tutto simili a quelli in ottone.
 Nel tubo di entrata, il filetto di collegamento alla piletta è integrato con il resto del tubo, per una installazione più facile e veloce. Completamente ispezionabili per la pulizia periodica.
 Tutti i sifoni di questa sezione (ad esclusione dei sifoni 2601020-2601027), vengono forniti con una riduzione 1" - 1"1/4 così da collegare lo stesso sifone a qualsiasi piletta.

SIFONE ABS A VISTA



codice	Ø	tubo uscita (lungh. mm)	UM	min. ord.	conf.	cat.	prezzo (€)
● 2601020	1"1/4x32	300	NR	1	10	05	55,94

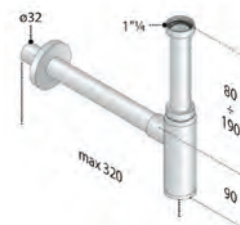

SIFONE ABS A "S"



codice	Ø	tubo uscita (lungh. mm)	UM	min. ord.	conf.	cat.	prezzo (€)
● 2601024	1"-1"1/4x32	250	NR	1	30	05	20,77

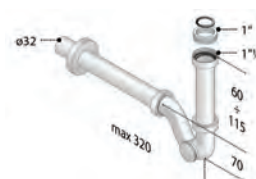

SIFONE ABS A "U"



codice	Ø	tubo uscita (lungh. mm)	UM	min. ord.	conf.	cat.	prezzo (€)
● 2601025	1"-1"1/4x32	250	NR	1	30	05	20,77

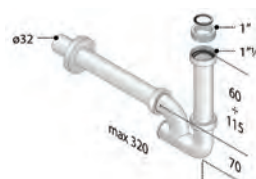

SIFONE ABS BOTTIGLIA

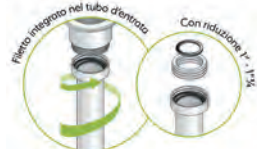
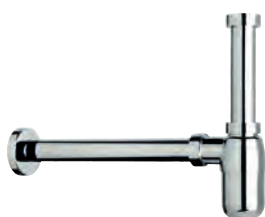

codice	Ø	tubo uscita (lungh. mm)	UM	min. ord.	conf.	cat.	prezzo (€)
● 2601021	1"-1"1/4x32	250	NR	1	30	05	20,77

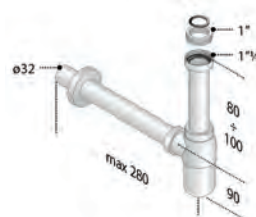

SIFONE ABS A "P"

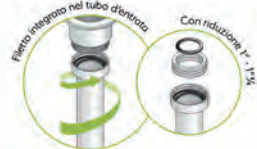

codice	Ø	tubo uscita (lungh. mm)	UM	min. ord.	conf.	cat.	prezzo (€)
● 2601028	1"-1"1/4x32	220	NR	1	15	05	22,94



SIFONE ABS, SALVASPAZIO



codice	sigla	Ø	tubo uscita (lungh. mm)	UM	min. ord.	conf.	cat.	prezzo (€)
● 2601027	-126.013.5.H	1"1/4x32	220	NR	1	15	05	34,53



**COMPLEMENTI
 SANITARI**

SIFONAME

SIFONI PP LAVABO BIDET

SIFONE IN PP RIDOTTO

Filetto integrato nel tubo di entrata.



Filetto integrato nel tubo d'entrata

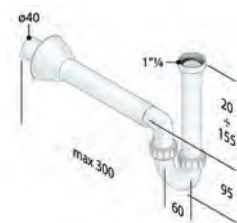

codice	∅	tubo uscita (lungh. mm)	UM	min. ord.	conf.	cat.	prezzo (€)
● 2105101	1"1/4x40	300	NR	1	30	01	9,37

SIFONE IN PP RIBASSATO

Filetto integrato nel tubo di entrata.



Filetto integrato nel tubo d'entrata

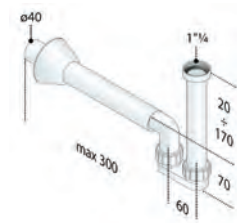

codice	∅	tubo uscita (lungh. mm)	UM	min. ord.	conf.	cat.	prezzo (€)
● 2105001	1"1/4x40	300	NR	1	30	01	9,11

SIFONE IN PP PASSAGGIO ACQUA MAGGIORATO

Filetto integrato nel tubo di entrata.



Filetto integrato nel tubo d'entrata

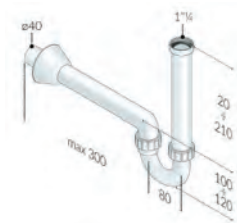

codice	∅	tubo uscita (lungh. mm)	UM	min. ord.	conf.	cat.	prezzo (€)
● 2602007	1"1/4x40	300	NR	1	30	01	11,32

SIFONE IN PP SALVASPAZIO

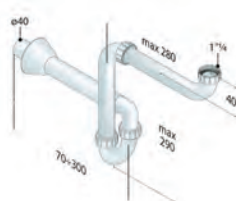

codice	∅	tubo uscita (lungh. mm)	UM	min. ord.	conf.	cat.	prezzo (€)
● 2204104	1"1/4x40	300	NR	1	15	01	17,79

SIFONE IN PP MINIMO INGOMBRO

Ingombro minimo a parete (43 mm) e sotto-piletta (32 mm).
Senza tubo di uscita e senza collegamento al troppo pieno.

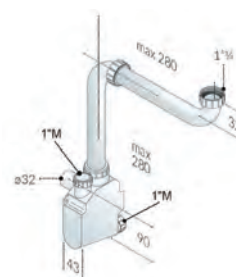

codice	sigla	∅	UM	min. ord.	conf.	cat.	prezzo (€)
● 2204106	1650.500.5	1"1/4x32	NR	1	16	01	20,06

SIFONE IN PP, LAVELLO 1 BACINO, 2 ATTACCHI LAVATRICE



codice	∅	tubo uscita (lungh. mm)	UM	min. ord.	conf.	cat.	prezzo (€)
● 2203001	1"1/2x40	250	NR	1	10	01	15,38

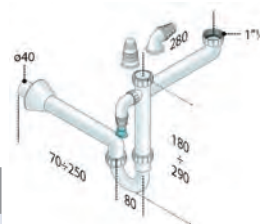

SIFONE IN PP, LAVELLO 2 BACINI, 2 ATTACCHI LAVATRICE



codice	∅	tubo uscita (lungh. mm)	UM	min. ord.	conf.	cat.	prezzo (€)
● 2203101	1"1/2x40	250	NR	1	10	01	20,20

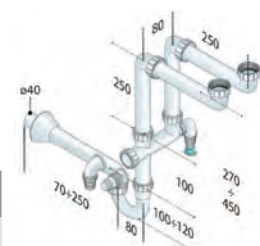

SIFONE IN PP, LAVELLO 1 BACINO, 2 ATTACCHI LAVATRICE



codice	∅	tubo uscita (lungh. mm)	UM	min. ord.	conf.	cat.	prezzo (€)
● 2204102	1"1/2x40	300	NR	1	30	01	9,77

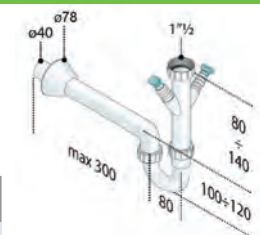

SIFONE IN PP, LAVELLO 2 BACINI, 2 ATTACCHI LAVATRICE



codice	∅	tubo uscita (lungh. mm)	UM	min. ord.	conf.	cat.	prezzo (€)
● 2204103	1"1/2x40	300	NR	1	15	01	16,37

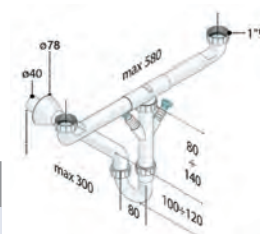

SIFONE IN PP A FIASCO, LAVELLO 1 BACINO, 2 ATTACCHI LAVATRICE



codice	∅	tubo uscita (lungh. mm)	UM	min. ord.	conf.	cat.	prezzo (€)
● 2205102	1"1/2x40	300	NR	1	15	01	9,90



SIFONE IN PP A FIASCO, LAVELLO 2 BACINI, 2 ATTACCHI LAVATRICE



codice	∅	tubo uscita (lungh. mm)	UM	min. ord.	conf.	cat.	prezzo (€)
● 2205104	1"1/2x40	300	NR	1	15	01	15,21

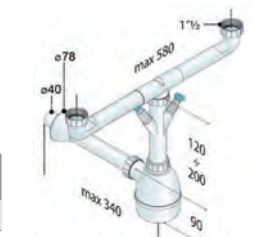

**COMPLEMENTI
SANITARI**

LE CARATTERISTICHE CHE ACCOMUNANO TUTTI I DIVERSI TIPI DI SCARICO SONO:

- 1) sifone estraibile per pulizie periodiche e per ispezionare o disotturare le tubazioni poste a valle
- 2) griglie regolabili in altezza (escluso Basicflow)
- 3) piedini di regolazione per facilitare la posa
- 4) telo perimetrale per impermeabilizzazione, fissabile direttamente con la colla per piastrelle

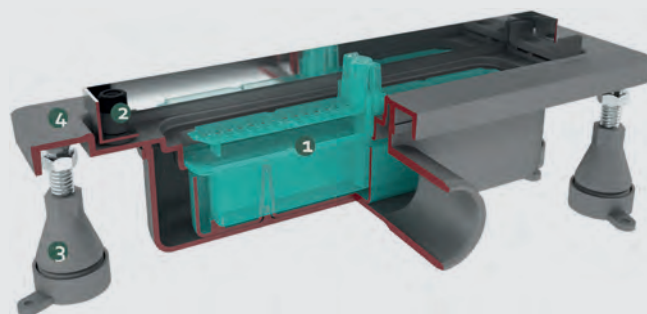

NANOFLOW PIASTRELLABILE



Caratteristiche:

- canalina in ABS
- griglia acciaio inox regolabile in altezza per pavimenti di spessore 15-25 mm
- griglia piastrellabile o in acciaio inox AISI 316 satinato
- ingombro sotto il pavimento di 75 mm
- chiusura idraulica 35 mm
- portata d'acqua 40 lt/min

codice	sigla	griglia (mm)	UM	min. conf.	ord. cat.	prezzo (€)
2304950	-953.101.8.	300x50	NR	1	04	203,42
2304954	-953.701.8.	500x50	NR	1	04	319,95
2304955	-953.801.8.	600x50	NR	1	04	319,95
2304951	-953.901.8.	700x50	NR	1	04	341,00
2304952	-953.201.8.	800x50	NR	1	04	359,79
2304953	-953.301.8.	900x50	NR	1	04	414,47

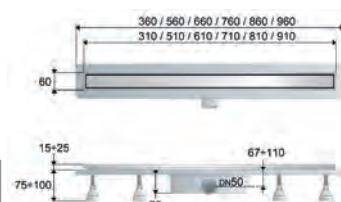

BASICFLOW



Caratteristiche:

- canalina in ABS
- realizzato in unico pezzo
- ottimo rapporto qualità/prezzo
- griglia in acciaio inox AISI 316 non regolabile in altezza, con possibilità di foggia diversa
- ingombro sotto il pavimento di 70 mm
- chiusura idraulica 35 mm
- portata d'acqua 39 lt/min

codice	sigla	griglia (mm)	UM	min. conf.	ord. cat.	prezzo (€)
2304960	-943.506.8.	400x43	NR	1	04	125,15
2304963	-943.906.8.	700x43	NR	1	04	187,67
2304964	-943.206.8.	800x43	NR	1	04	211,17
2304965	-943.306.8.	900x43	NR	1	04	234,64

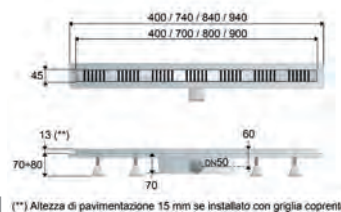

(**) Altezza di pavimentazione 15 mm se installato con griglia coprente

SUMISURA



Caratteristiche:

- canalina in ABS
- regolabile in lunghezza da max 1.200 mm a min. 430 mm
- griglia acciaio inox AISI 316 regolabile in altezza da 7 a 22 mm
- supporti scorrevoli adatti a ogni lunghezza e regolabili in altezza
- chiusura idraulica 35 mm
- portata d'acqua 36 lt/min
- ingombro sotto il pavimento di 75mm
- compreso DIMA per il corretto taglio della canalina e della griglia

Con i raccordi speciali (2304972 e 2304974) è possibile assemblare più canaline

codice	sigla	misura (mm)	finitura	UM	min. conf.	ord. cat.	prezzo (€)
2304970	-983.201.8	430÷800	inox	NR	1	04	354,05
2304971	-983.401.8	430÷1200	inox	NR	1	04	425,20
2394970	-983.201.8.N	430÷800	PVD nero	NR	1	04	496,25
2394971	-983.401.8.N	430÷1200	PVD nero	NR	1	04	567,39

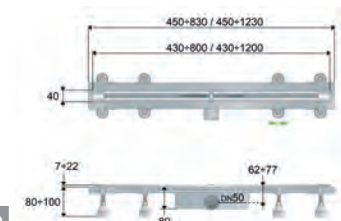

RACCORDO LINEARE PER GIUNZIONE SET SUMISURA



	codice	sigla	UM	min. ord. conf.	cat.	prezzo (€)
●	2304972	-987.000.0	NR	1	04	28,52

RACCORDO ANGOLARE PER GIUNZIONE SET SUMISURA

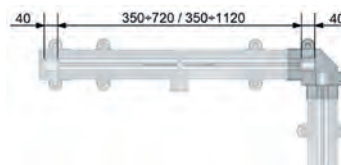

	codice	sigla	UM	min. ord. conf.	cat.	prezzo (€)
●	2304974	-987.004.0.	NR	1	04	44,33

MINIFLOW LINEARE

Caratteristiche:

- griglia in acciaio inox con possibilità di fogge diverse
- porta-griglia regolabile in altezza
- ingombro sotto il pavimento di 85 mm
- chiusura idraulica 35 mm
- portata d'acqua 39 lt/min

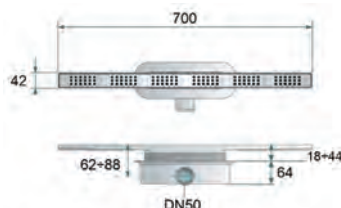

	codice	sigla	griglia (mm)	telo (mm)	UM	min. ord. conf.	cat.	prezzo (€)
●	2304802	-963.106.8.	700x42	1000x500	NR	1	04	164,30

MINIFLOW QUADRATO

Caratteristiche:

- griglia in acciaio inox con possibilità di fogge diverse
- porta-griglia regolabile in altezza
- ingombro sotto il pavimento di 85 mm
- chiusura idraulica 35 mm
- portata d'acqua 36 lt/min

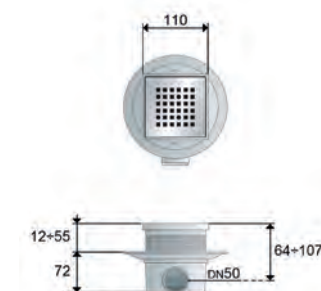
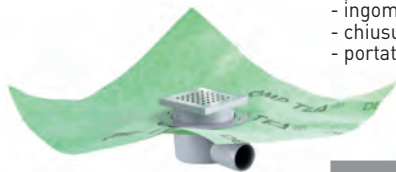

	codice	sigla	griglia (mm)	telo (mm)	UM	min. ord. conf.	cat.	prezzo (€)
●	2304801	-971.101.8.	110x110	500x500	NR	1	04	72,01

SIFONE PAVIMENTO IN OTTONE GRIGLIA OTTONE mm. 120

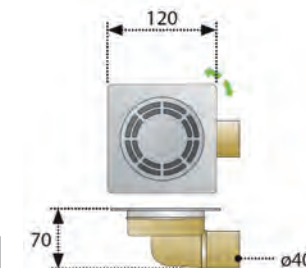

	codice	sigla	Ø	UM	min. ord. conf.	cat.	prezzo (€)	
●	2403001	--65.400.6.	120x40	NR	1	15	01	38,94

SIFONAME

SIFONI PAVIMENTO

SIFONE PAVIMENTO IN OTTONE GRIGLIA OTTONE CROMATO mm.100



codice	sigla	Ø	UM	min. ord.	conf.	cat.	prezzo (€)
● 2403101	--62.405.5.	100x1"1/4	NR	2	30	01	28,05

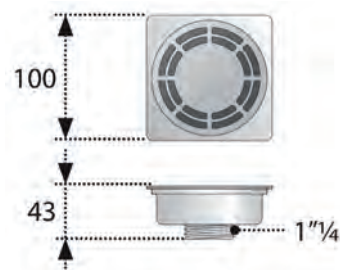

SIFONE PAVIMENTO ABS GRIGLIA INOX mm.105



codice	sigla	Ø	UM	min. ord.	conf.	cat.	prezzo (€)
● 2402401	-265.201.8.	105x50	NR	1	10	01	31,05

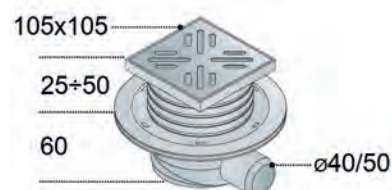

SIFONE PAVIMENTO ABS GRIGLIA OTTONE CROMATO mm.120

Griglia regolabile in altezza. Cornice quadra orientabile. Flangia per predisposizione all'impermeabilizzazione a letto sottile. Ridotto ingombro sotto traccia (6 cm). Adatto per esterno. Ispezionabile. Per evitare allagamenti, reflussi, cattivi odori a causa dello svuotamento del sifone, è possibile inserire il sifone a secco con sistema a clapet (2661099).



codice	sigla	Ø	UM	min. ord.	conf.	cat.	prezzo (€)
● 2403401	2665.491.8.	120x50	NR	1	10	01	59,53

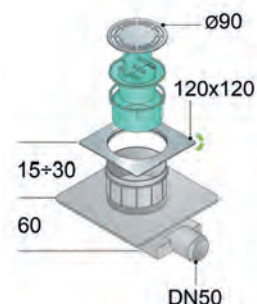

SIFOIDE PAVIMENTO ABS GRIGLIA ACCIAIO INOX AISI 316 mm.115

Griglia PIASTRELLABILE regolabile in altezza. Cornice quadra orientabile. Flangia per predisposizione all'impermeabilizzazione a letto sottile. Ridotto ingombro sotto traccia (6 cm). Adatto per esterno. Ispezionabile. Per evitare allagamenti, reflussi, cattivi odori a causa dello svuotamento del sifone, è possibile inserire il sifone a secco con sistema a clapet (2661099).

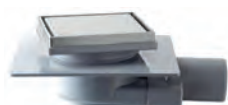

codice	sigla	Ø	UM	min. ord.	conf.	cat.	prezzo (€)
● 2403402	-2665.492.8	115x50	NR	1	10	01	99,92

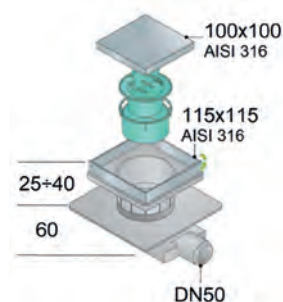

SIFONE A SECCO PER SIFOIDE

Con sistema clapet per sifoide a pavimento 2403401, 2403402.



codice	sigla	UM	min. ord.	conf.	cat.	prezzo (€)
● 2661099	-137.013.0.	NR	1	20		22,84

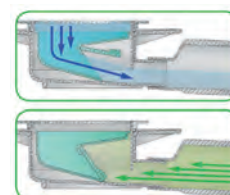

SIFONI E PILETTE PIATTI DOCCIA

SIFONE PIATTO DOCCIA CON FORO D.90, SENZA GRIGLIA, RIBASSATO

Senza griglia copripiletta, sifone e cestello ferma-capelli amovibili, guarnizione doppio labbro per piatti doccia in acrilico e in ceramica, uscita liscia D.40 per attacco diretto. Basso ingombro, portata d'acqua 27 lt/min. Fissaggio con viti.

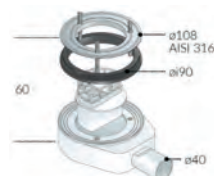

codice	sigla	piletta Ø	uscita Ø	UM	min. ord.	min. ord.	conf.	prezzo (€)
● 2303012	6621.001.6.	110	40	NR	1	16	01	36,17

SIFONE PIATTO DOCCIA CON FORO D.90, GRIGLIA IN ABS CROMO, RIBASSATO

Griglia coprente D.118 in ABS, sifone e cestello ferma-capelli amovibili, guarnizione tre lamelle adatta ai piatti doccia in acrilico che quelli in ceramica, uscita con ghiera. Basso ingombro, portata d'acqua maggiorata. Fissaggio con viti.

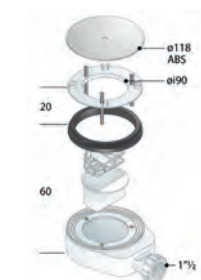

RICAMBI (PAG. 199)
2661106 - Griglia

codice	piletta Ø	uscita Ø	UM	min. ord.	conf.	cat.	prezzo (€)
● 2303007	110	1"1/2	NR	16	01		29,04

SIFONE PIATTO DOCCIA CON FORO D.90, GRIGLIA IN ABS CROMO, RIBASSATO

Griglia coprente D.118 in ABS, sifone e cestello ferma-capelli amovibili, guarnizione tre lamelle adatta ai piatti doccia in acrilico che quelli in ceramica, uscita con codolo 45° in PP. Basso ingombro, portata d'acqua maggiorata. Fissaggio con viti.

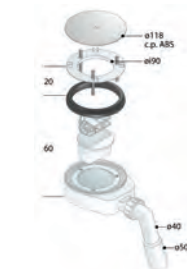

RICAMBI (PAG. 199)
2661106 - Griglia

codice	piletta Ø	uscita Ø	UM	min. ord.	conf.	cat.	prezzo (€)
● 2303008	110	40-50	NR	12	01		34,49

SIFONE PIATTO DOCCIA CON FORO D.90, GRIGLIA METALLICA, RIBASSATO

Griglia coprente D.118 metallica colorata, sifone e cestello ferma-capelli amovibili, uscita con ghiera. Basso ingombro. Fissaggio con viti.

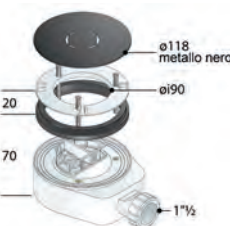

codice	sigla	finitura	piletta Ø	uscita Ø	UM	min. ord.	conf.	cat.	prezzo (€)
2303911	6261.086.6.X	nero opaco	110	1"1/2	NR	1	16	01	78,24
2303711	6261.086.6.XD	bianco opaco	110	1"1/2	NR	1	16	01	78,24

SIFONE PIATTO DOCCIA CON FORO D.50 E D.60, GRIGLIA OTTONE, RIBASSATO

Griglia D.45 in ottone cromo, sifone e cestello ferma-capelli amovibili, uscita con ghiera. Basso ingombro. Fissaggio con viti.

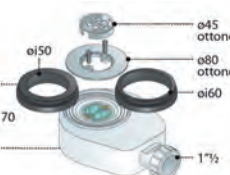

codice	sigla	piletta Ø	uscita Ø	UM	min. ord.	conf.	cat.	prezzo (€)
● 2303009	6461.066.6.	80	1"1/2	NR	1	16	01	24,59

SIFONE PIATTO DOCCIA CON FORO D.50 E D.60, GRIGLIA IN ABS CROMO, RIBASSATO

Griglia coprente D.85 in ABS, sifone e cestello ferma-capelli amovibili, uscita con ghiera. Basso ingombro. Fissaggio con viti.

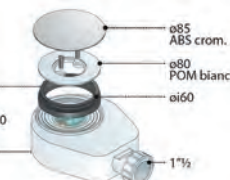

codice	sigla	piletta Ø	uscita Ø	UM	min. ord.	conf.	cat.	prezzo (€)
● 2303010	6461.096.6.	80	1"1/2	NR	1	16	01	20,69

SIFONAME

SIFONI E PILETTE PIATTI DOCCIA

SIFONE PIATTO DOCCIA CON FORO D.60 , GRIGLIA OTTONE CROMO, ORIENTABILE

Griglia D.45 ottone cromo, cestello ferma-capelli amovibile, uscita orientabile liscia in PEHD saldabile con tubi in PE.

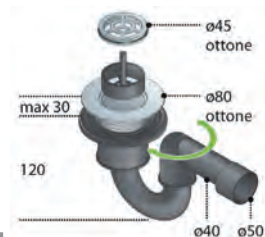

codice	entrata Ø	uscita Ø	UM	min. ord.	conf.	cat.	prezzo (€)
● 2302101	80	40-50	NR	1	30	01	26,10

SIFONI E COLONNE SCARICO VASCA

SIFONE VASCA IN PP, USCITA ORIENTABILE A SALDARE

Sifone ribassato, entrata con dado in ottone, uscita orientabile liscia in PEHD saldabile con tubi in PE.

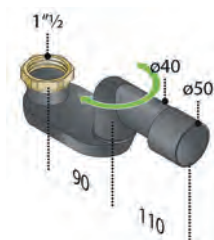

codice	sigla	entrata Ø	uscita Ø	UM	min. ord.	conf.	cat.	prezzo (€)
● 2302102	-290.400.8.	1"1/2	40-50	NR	1	30	01	14,29

SIFONE VASCA IN PP, USCITA ORIENTABILE CON GHIERA

Sifone ribassato, entrata con dado in ottone, uscita orientabile con ghiera in PP.

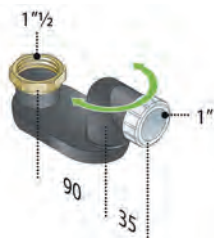

codice	sigla	entrata Ø	uscita Ø	UM	min. ord.	conf.	cat.	prezzo (€)
● 2302104	-290.407.6.	1"1/2	1"1/2	NR	1	30	01	15,11

COLONNA VASCA IN PP TUBO RIGIDO, CON SIFONE ORIENTABILE

Comando a cavo inox, sifone pre-assemblato con codolo 45°, tappo D.45 in ottone, griglia tappo troppo pieno in metallo cromato.

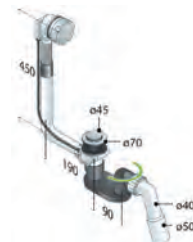

codice	uscita Ø	UM	min. ord.	conf.	cat.	prezzo (€)
● 2304309	40-50	NR	1	10	01	65,34

PILETTA AUTOMATICA UNIVERSALE



NOVITÀ!

Ideale per lavabi di diversi spessori, tappo coprente in acciaio inox, meccanismo clicker, vite centrale passante da 80 mm.

codice	Ø	tappo (mm)	UM	min. ord.	conf.	cat.	prezzo (€)
● 2106500	1"1/4	63,5	NR	1	1	01	60,06



PILETTE OTTONE LAVABO BIDET

PILETTA AUTOMATICA UNIVERSALE



Ideale per lavabi di diversi spessori, tappo coprente in ottone cromato, meccanismo clicker, vite centrale passante da 75 mm.

codice	sigla	Ø	tappo (mm)	UM	min. ord. conf.	cat.	prezzo (€)
● 2106020	8532.310.5.	1"1/4	63	NR	15	01	34,78

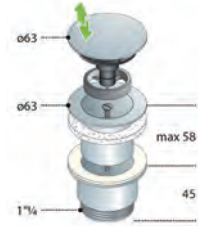

PILETTA UNIVERSALE MINIMO INGOMBRO



Meccanismo clicker, tappo coprente, vite passante per lavabi di spessore fino a 60 mm. Tappo metallico D.63



codice	sigla	finitura	Ø	UM	min. ord.	conf.	cat.	prezzo (€)
● 2106037	7532.310.5	cromo	1"1/4	NR	1	15	01	32,51
● 2106937	7532.310.5.X	nero opaco	1"1/4	NR	1	15	01	67,29
● 2106737	7532.310.5.XD	bianco opaco	1"1/4	NR	1	15	01	67,29
● 2106837	7532.310.5.Y2	simil acciaio	1"1/4	NR	1	15	01	100,91



PILETTA UNIVERSALE MINIMO INGOMBRO, TAPPO CERAMICO



Meccanismo clicker, tappo coprente, vite passante per lavabi di spessore fino a 60 mm. Tappo ceramico D.70.



codice	sigla	finitura	Ø	UM	min. ord.	conf.	cat.	prezzo (€)
● 2106537	7532.310.5.T2	nero opaco	1"1/4	NR	1	15	01	59,04
● 2106637	7532.310.5.T1	bianco opaco	1"1/4	NR	1	15	01	59,04
● 2106437	7532.310.5.T	bianco lucido	1"1/4	NR	1	15	01	52,34

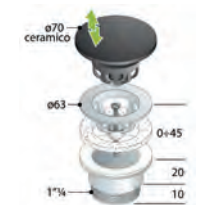

PILETTA AUTOMATICA UNIVERSALE



Per qualsiasi spessore, con scanalatura per facilitare il taglio e dotata di dispositivo di chiusura del troppo pieno (*), tappo coprente in ottone cromato, meccanismo clicker.

RICAMBI (PAG. 198)
2661076 - Tappo cromo

codice	finitura	Ø	controdado H (mm)	tappo (mm)	UM	min. ord.	conf.	cat.	prezzo (€)
● 2106029	cromo	1"1/4	80	63	NR	1	15	01	42,50
● 2106929	nero opaco	1"1/4	80	63	MR	1	15	01	87,38

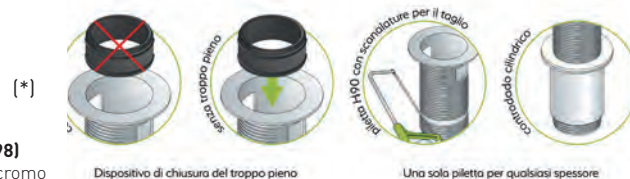

RICAMBI (PAG. 198)
2661076 - Tappo cromo

codice	Ø	controdado H (mm)	tappo (mm)	UM	min. ord.	conf.	cat.	prezzo (€)
● 2106035	1"1/4	40	63	NR	1	15	01	38,28

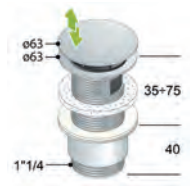
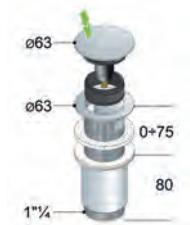

COMPLEMENTI SANITARI

SIFONAME

PILETTE OTTONE LAVABO BIDET

PILETTA AUTOMATICA LAVABO/BIDET TAPPO COPRENTE



Meccanismo clicker.

RICAMBI (PAG. 198)
2661076 - Tappo

codice	Ø	tappo (mm)	descrizione	UM	min. ord. conf.	cat.	prezzo (€)
● 2106012	1"1/4	63	con troppo pieno	NR	15	01	33,43
● 2106013	1"1/4	63	senza troppo pieno	NR	15	01	33,43

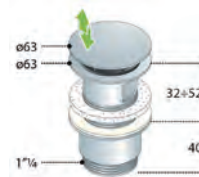

PILETTA A SCARICO LIBERO



Con griglia ferma capelli estraibile, vite centrale passante da 75 mm.

codice	sigla	Ø	griglia (mm)	UM	min. ord. conf.	cat.	prezzo (€)
● 2106015	-542.710.5.	1"1/4	65	NR	1	15	32,08

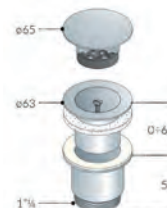

PILETTA TAPPO SALTERELLO, SENZA COMANDO

Piletta in ottone, tappo in ottone.



RICAMBI (PAG. 199)
2661095 - Tappo

codice	Ø	tappo (mm)	UM	min. ord. conf.	cat.	prezzo (€)	
● 2106003	1"1/4x63	40	NR	1	30	01	26,86
● 2106002	1" x63 (fuori norma)	40	NR	1	30	01	26,86

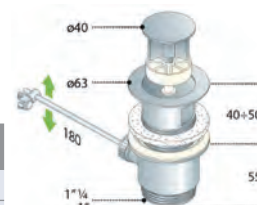

TAPPO COPRENTE CLICKER

Con sistema clicker per sostituzione tappo su vecchie pilette da 1"1/4.



codice	sigla	Ø	UM	min. ord. conf.	cat.	prezzo (€)
● 2661097	8120.378.5	63	NR	10	20	29,57



PILETTA IN OTTONE TAPPO SALTERELLO IN PVC, SENZA COMANDO

Piletta in ottone, tappo in PVC.



codice	Ø	tappo (mm)	UM	min. ord. conf.	cat.	prezzo (€)	
● 2106034	1"1/4x63	37,9	NR	1	50	01	12,47
● 2106025	1" x63 (fuori norma)	37,9	NR	1	50	01	12,05

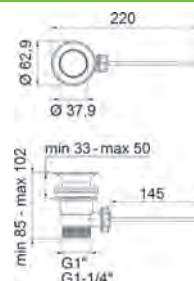

PILETTA CON TAPPO E CATENELLA

Piletta in ottone H.70 mm, sottoparte in resina acetilica (POM).



codice	sigla	Ø	tappo (mm)	descrizione	UM	min. ord. conf.	cat.	prezzo (€)	
● 2106008	-329.120.5.	1"1/4x63	40,5	con troppo pieno	NR	1	30	01	11,72
● 2106007	-329.120.4.	1" x63	40,5	con troppo pieno	NR	1	30	01	11,25
● 2106102	-329.020.5.	1"1/4x63	40,5	senza troppo pieno	NR	1	30	01	11,72
● 2106101	-329.020.4.	1" x63	40,5	senza troppo pieno	NR	1	30	01	11,25



PILETTE OTTONE LAVABO BIDET

SET COLLEGAMENTO CON TROPPO PIENO PP-GRIGLIA OTTONE PER LAVABO



Per lavabo con spessore 5÷20 mm per fori D. 30 mm.
Tubo flessibile lunghezza max 300 mm.

●	codice	sigla	UM	min. ord.	conf.	cat.	prezzo (€)
	2304317	-247.604.0.	NR	1	15	01	15,81



PILETTE LAVELLO

PILETTA IN PP LAVELLI INOX FORO D.90, CON TROPPO PIENO, TAPPO INOX



Tappo cestello inox estraibile, troppo pieno con tubo flessibile

RICAMBI (PAG. 198-199)
2661061 - Vite prolungata 65 mm
2661058 - Tappo

●	codice	sigla	Ø	tappo (mm)	UM	min. ord.	conf.	cat.	prezzo (€)
	2201001	-133.605.6.	1"1/2x115	80	NR	1	10	01	18,18

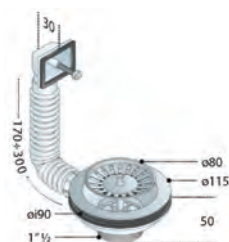

PILETTA IN PP LAVELLI INOX FORO D.90, SENZA TROPPO PIENO, TAPPO INOX



Tappo cestello D.80 inox estraibile.

RICAMBI (PAG. 198-198)
2661061 - Vite prolungata 65 mm
2661058 - Tappo

●	codice	sigla	Ø	tappo (mm)	UM	min. ord.	conf.	cat.	prezzo (€)
	2201101	-133.505.6.	1"1/2x115	80	NR	1	15	01	14,95

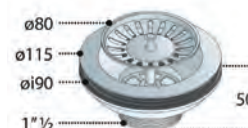

PILETTA IN PP LAVELLI INOX FORO D.60, CON TROPPO PIENO, TAPPO E CATENELLA



Gattinara inox, tappo in gomma catenella e vite.
Troppo pieno con tubo flessibile.

●	codice	sigla	Ø	tappo (mm)	UM	min. ord.	conf.	cat.	prezzo (€)
	2201002	-232.840.6.	1"1/2x70	45	NR	1	30	01	9,50

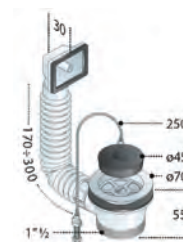

PILETTA IN PP LAVELLI INOX FORO D.60, SENZA TROPPO PIENO

Gattinara inox, tappo in gomma con catenella e vite.



●	codice	sigla	Ø	tappo (mm)	UM	min. ord.	conf.	cat.	prezzo (€)
	2201102	-232.540.6.	1"1/2x70	45,5	NR	1	10	01	7,19
	2201103	-234.540.6.	1"1/2x70	50,0	NR	1	10	01	7,00

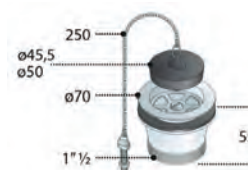

SIFONAME

PILETTE LAVELLO

PILETTONE SIFOIDE LAVELLO, TAPPO E CATENELLA



Griglia-cestello in ottone, sottoparte in ottone.

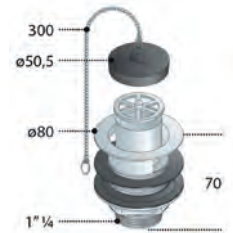

codice	sigla	Ø	tappo (mm)	UM	min. ord.	conf.	cat.	prezzo (€)
● 2201202	--37.125.5.	1"1/4x80	50,5	NR	1	15	01	27,72

PILETTA GATTINARA LAVELLI IN FC



Gattinara inox, sottoparte in PP.

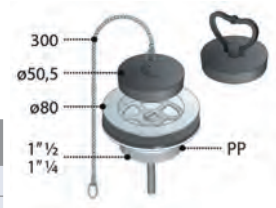

codice	sigla	Ø	descrizione	UM	min. ord.	conf.	cat.	prezzo (€)
● 2202001	-234.625.5.	1"1/4x80	con catenella	NR	1	10	01	6,34
● 2202002	-234.625.6.	1"1/2x80	con catenella	NR	1	10	01	6,86
● 2202003	-234.635.6.	1"1/2x80	con maniglia	NR	1	10	01	5,71

PILETTA GATTINARA



Sottoparte in ottone, tappo con catenella, gattinara inox.

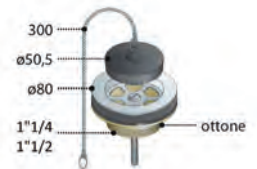

codice	sigla	Ø	tappo (mm)	UM	min. ord.	conf.	cat.	prezzo (€)
● 2201201	--34.625.5.	1"1/4x80	50,5	NR	1	50	01	9,64
● 2602015	--34.625.6.	1"1/2x80	50,5	NR	1	50	01	9,64

TUBI CROMATI IN OTTONE

TUBO ORLATO

Con cartella ribattuta.



codice	Ø	lungh. (cm)	UM	min. ord. conf.	cat.	prezzo (€)
● 2651018	26	20	NR	10	09	6,16
● 2651020	26	25	NR	10	09	6,80
● 2651022	26	30	NR	10	09	7,52
● 2651031	30	30	NR	10	09	8,76
● 2651019	32	20	NR	10	09	7,20
● 2651021	32	25	NR	10	09	8,00
● 2651023	32	30	NR	10	09	8,76

TUBO LISCIO



codice	Ø	lungh. (cm)	UM	min. ord. conf.	cat.	prezzo (€)
● 2750831	26	25	NR	10	09	5,52
● 2750834	26	30	NR	10	09	6,40
● 2750838	26	100	NR	10	09	22,00
● 2750832	30	25	NR	10	09	6,12
● 2750835	30	30	NR	10	09	6,92
● 2750833	32	25	NR	10	09	6,40
● 2750836	32	30	NR	10	09	7,36
● 2750839	32	100	NR	1	09	25,00

TUBO PIEGHEVOLE



codice	Ø	lungh. (cm)	UM	min. ord. conf.	cat.	prezzo (€)
● 2750841	26	30	NR	10	09	11,04
● 2750842	30	30	NR	10	09	11,80
● 2750844	32	25	NR	10	09	12,80
● 2750843	32	30	NR	10	09	13,24

TUBO ECCENTRICO



codice	sigla	Ø	lungh. (cm)	UM	min. ord. conf.	cat.	prezzo (€)
● 2651028	--92.300.4.	26	30	NR	10	09	15,28
● 2750871	-	30	30	NR	5	09	14,96
● 2750872	-	32	30	NR	5	09	15,76

CURVA 90° LISCIA



codice	Ø	lungh. (cm)	UM	min. ord. conf.	cat.	prezzo (€)
● 2651016	30	15x25	NR	5	09	13,76
● 2651017	30	20x30	NR	5	09	17,24

TUBO A GOMITO



codice	Ø	lungh. (cm)	UM	min. ord. conf.	cat.	prezzo (€)
● 2750881	30	26	NR	5	09	9,76

PROLUNGA CON O-RING



codice	Ø	lungh. (cm)	UM	min. ord. conf.	cat.	prezzo (€)
● 2651001	26	13	NR	10	09	5,32
● 2651003	30	13	NR	10	09	6,04
● 2651002	32	13	NR	10	09	6,04

GIUNZIONE CON 2 O-RING



codice	Ø	UM	min. ord. conf.	cat.	prezzo (€)
● 2661049	26	NR	10	09	5,68
● 2661050	30	NR	10	09	6,52
● 2661051	32	NR	10	09	6,72

SIFONAME

TUBI CROMATI IN OTTONE

GIUNZIONE RIDOTTA CON 2 O-RING



codice	∅	UM	min. ord. conf.	cat.	prezzo (€)
● 2661053	32x26	NR	10	09	7,52
● 2661054	40x32	NR	10	09	9,12

TUBO ORLATO CON GHIERA



codice	∅	lung. (cm)	UM	min. ord. conf.	cat.	prezzo (€)
● 2651039	1"1/4x26	25	NR	10	09	11,52

TUBO ORLATO CON ATTACCO LAVATRICE



codice	sigla	∅	lung. (cm)	UM	min. ord. conf.	cat.	prezzo (€)
● 2651033	--97.205.5.	1"1/4x32	20	NR	10	09	26,56

TUBO CON AERATORE



codice	sigla	∅	lung. (cm)	UM	min. ord. conf.	cat.	prezzo (€)
● 2651005	-159.250.5.	32	25	NR	1	09	38,88

TUBI CROMATI IN ABS

TUBO LISCIO ABS CROMO



codice	∅	lung. (cm)	UM	min. ord. conf.	cat.	prezzo (€)
● 2651081	32	25	NR	10	09	5,04
● 2651082	32	30	NR	10	09	6,80

TUBO ORLATO ABS CROMO

Cond dado e guarnizione.



codice	∅	lung. (cm)	UM	min. ord. conf.	cat.	prezzo (€)
● 2651080	1"1/4x32	30	NR	10	09	10,16

TUBO ESTENSIBILE

Estensibilità 30-80 cm.
Ghiera metallica e rosone in plastica (2651042 senza rosone)



codice	Ø	UM	min. ord. conf.	cat.	prezzo (€)
● 2651044	1"x26	NR	1	23	6,78
● 2651045	1"x32	NR	1	23	6,78
● 2651042	1"1/4x32/40	NR	1	20	6,73

TUBO ESTENSIBILE

Estensibilità 45-78 cm.
Ghiera in PP



codice	sigla	Ø	UM	min. ord. conf.	cat.	prezzo (€)
● 2651036	-485.906.5.	1"1/4x32	NR	30	30	3,34
● 2651037	-485.906.6.	1"1/2x40	NR	1	30	3,34

DADO ESAGONALE OTTONE CROMATO



codice	sigla	Ø	UM	min. ord. conf.	cat.	prezzo (€)
● 2661001	-114.000.4.	1"	NR	10	20	2,95
● 2661002	-114.000.5.	1"1/4	NR	10	20	2,95

RIDUZIONE FILETTATA IN PP



codice	sigla	Ø	UM	min. ord. conf.	cat.	prezzo (€)
● 2661027	-252.006.5.	F 1"1/4 x M 1"	NR	10	20	2,68
● 2661028	-252.006.6.	F 1"1/2 x M 1"1/4	NR	10	20	2,68

RIDUZIONE FILETTATA OTTONE CROMATO



codice	sigla	Ø	UM	min. ord. conf.	cat.	prezzo (€)
● 2661029	--52.006.5.	F 1"1/4 x M 1"	NR	10	20	9,28
● 2661030	--52.006.6.	F 1"1/2 x M 1"1/4	NR	10	20	17,64

RIDUZIONE FILETTATA IN PP

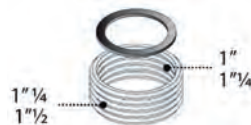

codice	sigla	Ø	UM	min. ord. conf.	cat.	prezzo (€)
● 2661100	-252.005.5.	F 1" x M 1"1/4	NR	10	20	2,68
● 2661084	-252.005.6.	F 1"1/4 x M 1"1/2	NR	10	20	2,68

TUBO IN PP

Tubo D. 40 con ghiera, 2 attacchi lavatrice.
In dotazione riduzione invisibile 1"1/2 x 1"1/4



codice	sigla	Ø	lung. (mm)	UM	min. ord. conf.	cat.	prezzo (€)
● 2501001	-297.116.6.	1"1/4-1"1/2	170	NR	10	20	8,05

TUBO IN PP

Tubo D. 32 con ghiera, 1 attacco lavatrice.
In dotazione riduzione invisibile 1"1/2 - 1"1/4.



codice	sigla	Ø	lung. (mm)	UM	min. ord. conf.	cat.	prezzo (€)
● 2661103	-297.219.5.	1"1/4-1"1/2	200	NR	10	20	5,54

PROLUNGA BIVALENTE IN PP

Tubo con ghiera a stringere con attacco lavatrice e tappo di chiusura. Utilizzabile anche come raccordo lavatrice non sifonato

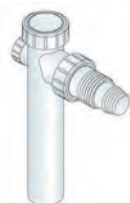

codice	sigla	Ø	lung. (mm)	UM	min. ord. conf.	cat.	prezzo (€)
● 2502003	2103.322.6.	40	230	NR	10	20	7,66

PROLUNGA CURVA IN PP

Curva a 90°, con ghiera a stringere



codice	sigla	Ø	lung. (mm)	UM	min. ord. conf.	cat.	prezzo (€)
● 2502101	2104.322.6.	1"1/2x40	250	NR	10	20	6,73

SIFONAME

ACCESSORI E RICAMBI SIFONAME

PROLUNGA IN PP

Con ghiera a stringere



codice	sigla	Ø (mm)	lung. (mm)	UM	min. ord. conf.	cat.	prezzo (€)
● 2502001	2100.322.6.	1"1/2x40	300	NR	10	20	5,59

TUBO ORLATO CON GHIERA IN PP + GUARNIZIONE

Con ghiera filettata femmina



codice	sigla	Ø	lung. (mm)	UM	min. ord. conf.	cat.	prezzo (€)
● 2661057	-286.206.6.	1"1/2x40	200	NR	10	20	4,27

CODOLO DIRITTO IN PeHD

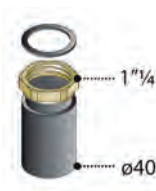

codice	sigla	Ø	UM	min. ord. conf.	cat.	prezzo (€)
● 2661033	-251.253.5.	1"1/4x40	NR	10	20	9,59

ANELLO SEPARATORE D.70, H.25 mm.

Con guarnizione, per pilette lavabi d'arredo sopra mobile.

La sua funzione è quella di separare il lavabo dal piano del mobile. In ottone.

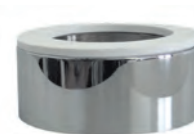

codice	sigla	UM	min. ord. conf.	cat.	prezzo (€)
● 2661094	--47.100.0.	NR	1	20	36,61

TAPPO COPRENTE

Ricambio per pilette automatiche
2106029
2106035
2106012
2106013.



codice	sigla	UM	min. ord. conf.	cat.	prezzo (€)	
● 2661076	-137.036.0.	NR	1	10	20	26,05

TAPPO CESTELLO INOX PER PILETTA LAVELLO

Con guarnizione 2661059.

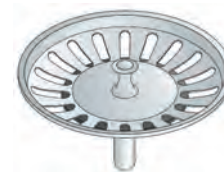

codice	sigla	Ø	UM	min. ord. conf.	cat.	prezzo (€)
● 2661058	-137.070.0.	80	NR	10	20	12,36

TAPPO PILETTA LAVABO-BIDET PESANTE

In metallo cromato, per piletta da 1"1/4



codice	Ø	UM	min. ord. conf.	cat.	prezzo (€)
● 2661011	40	NR	10	20	6,25

TAPPO PILETTA LAVABO-BIDET BASE

In plastica e ottone cromato, per piletta da 1"1/4 con vite antifurto



codice	Ø	UM	min. ord. conf.	cat.	prezzo (€)
● 3101012	40	NR	1	20	9,33

TAPPO PILETTA LAVABO-BIDET

In ottone cromato, per piletta da 1"1/4

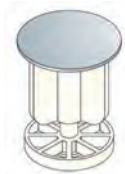

codice	Ø	UM	min. ord.	conf.	cat.	prezzo (€)
● 2661095	40	NR	1	10	20	11,09

TAPPO COPRENTE CLICKER

Con sistema clicker per sostituzione tappo su vecchie pilette da 1"1/4.



codice	sigla	Ø	UM	min. ord. conf.	cat.	prezzo (€)
● 2661097	8120.378.5	63	NR	10	20	29,57

SNODINO DOPPIO



codice	materiale	UM	min. ord.	conf.	cat.	prezzo (€)
● 2750660	ottone nichelato	NR	1	50	20	2,90

VITE PILETTA PROLUNGATA H.65 mm.

In sostituzione alla vite in dotazione (H. 30 mm) nelle pilette livello. 2201001 e 2201101.

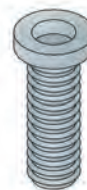

codice	sigla	UM	min. ord. conf.	cat.	prezzo (€)
● 2661061	-137.072.0.	NR	10	20	9,42

RACCORDO PP ECCENTRICO

Spostamento 3 cm.



codice	sigla	Ø	UM	min. ord. conf.	cat.	prezzo (€)
● 2661104	-292.155.5.	32x40	NR	10	20	6,12

GUARNIZIONE TAPPO CESTELLO

Guarnizione di ricambio per tappo 2661058



codice	sigla	UM	min. ord. conf.	cat.	prezzo (€)
● 2661059	-137.070.9	NR	10	20	1,19

SIFONE A SECCO PER SIFOIDE

Con sistema clapet per sifoide a pavimento 2403401, 2403402.

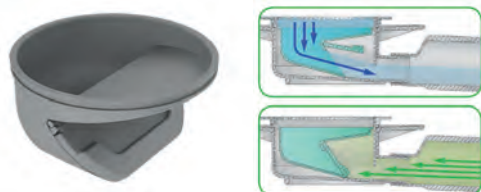

codice	sigla	UM	min. ord. conf.	cat.	prezzo (€)
● 2661099	-137.013.0.	NR	1	20	22,84

GRIGLIA COPRENTE ABS CROMO

Ricambio per sifone piatto doccia 2303007 e 2303008



codice	sigla	UM	min. ord. conf.	cat.	prezzo (€)	
● 2661106	-119.522.0.	NR	1	10	20	14,30

RUBINETTERIA SOTTOLAVABO, LAVATRICE E VARIA

RUBINETTI SOTTOLAVABO A SFERA

RUBINETTO SFERA CON FILTRO, CON SNODO CALOTTA BASSA



codice	sigla	attacco muro	calotta Ø	UM	min. ord.	conf.	cat.	prezzo (€)
● 2730203	0360B40ECR	1/2"	10	NR	2	50	06	15,95

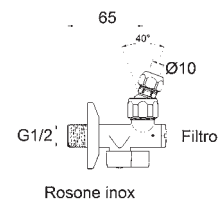

RUBINETTO SFERA CON FILTRO, CON SNODO CALOTTA ALTA



codice	sigla	attacco muro	uscita	battuta	calotta Ø	UM	min. ord.	conf.	cat.	prezzo (€)
● 2730217	0361A40ECR	1/2"	1/2"	piana	10	NR	50	06	17,06	

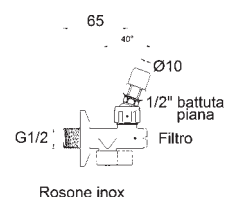

RUBINETTO SFERA CON FILTRO CALOTTA BASSA



codice	sigla	attacco muro	uscita	battuta	calotta Ø	UM	min. ord.	conf.	cat.	prezzo (€)
● 2730213	0350B40ECR	1/2"	3/8"	piana	10	NR	2	100	06	13,00

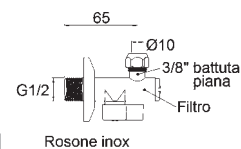

RUBINETTO SFERA CON FILTRO CALOTTA ALTA



codice	sigla	attacco muro	uscita	battuta	calotta Ø	UM	min. ord.	conf.	cat.	prezzo (€)
● 2730214	0350A40ECR	1/2"	3/8"	piana	10	NR	2	100	06	14,29

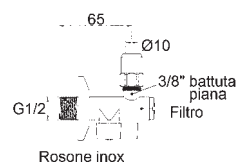

RUBINETTO SFERA CON FILTRO SENZA CALOTTA



codice	sigla	finitura	attacco muro	uscita	battuta	UM	min. ord.	conf.	cat.	prezzo (€)
● 2730216	0350040ECR	cromo	1/2"	3/8"	piana	NR	100	06	12,24	
● 2739216	03500401NO	nero opaco	1/2"	3/8"	piana	NR	2	06	57,74	
2737216	03500401BO	bianco opaco	1/2"	3/8"	piana	NR	2	06	57,74	
2738216	03500401SM	simil acciaio	1/2"	3/8"	piana	NR	2	06	57,74	

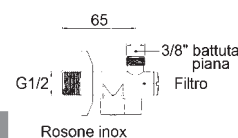

RUBINETTERIA SOTTOLAVABO, LAVATRICE E VARIA

RUBINETTI SOTTOLAVABO A VITONE

RUBINETTO VITONE CON FILTRO, CON SNODO CALOTTA BASSA

Corpo lungo cm. 8



codice	sigla	attacco muro	calotta Ø	UM	min. ord.	conf.	cat.	prezzo (€)
● 2730223	0417B400CR	1/2"	10	NR	2	50	06	14,83

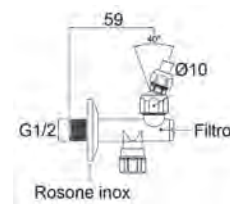

RUBINETTO VITONE CON FILTRO, CON SNODO CALOTTA BASSA

Corpo lungo cm. 8, battuta piana



codice	sigla	attacco muro	uscita	battuta	calotta Ø	UM	min. ord.	conf.	cat.	prezzo (€)
● 2730225	0418B400CR	1/2"	1/2"	piana	10	NR	2	50	06	15,59

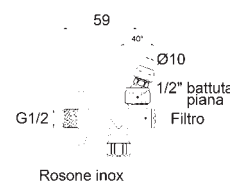

RUBINETTO VITONE CON FILTRO SENZA CALOTTA



codice	sigla	attacco muro	uscita	battuta	UM	min. ord.	conf.	cat.	prezzo (€)
● 2730261	04140400CR	1/2"	3/8"	piana	NR	100	06	12,24	

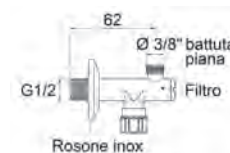

RUBINETTO VITONE SENZA FILTRO CALOTTA BASSA



codice	sigla	attacco muro	uscita	battuta	calotta Ø	UM	min. ord.	conf.	cat.	prezzo (€)
● 2730281	0500B400ECR	1/2"	3/8"	piana	10	NR	2	100	06	10,01

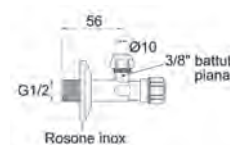

RUBINETTO VITONE SENZA FILTRO CALOTTA ALTA



codice	sigla	attacco muro	uscita	battuta	calotta Ø	UM	min. ord.	conf.	cat.	prezzo (€)
● 2730282	0500A400CR	1/2"	3/8"	piana	10	NR	2	100	06	11,12



RUBINETTO VITONE SENZA FILTRO SENZA CALOTTA



codice	sigla	attacco muro	uscita	battuta	UM	min. ord.	conf.	cat.	prezzo (€)
● 2730283	05000400ECR	1/2"	3/8"	piana	NR	2	100	06	9,07

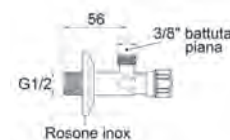

COMPLEMENTI
SANITARI

RUBINETTERIA SOTTOLAVABO, LAVATRICE E VARIA

CURVETTE SOTTOLAVABO

CURVETTA ESAGONALE 45° STAMPATA CALOTTA BASSA



codice	sigla	attacco muro	uscita	battuta	calotta Ø	UM	min. ord.	conf.	cat.	prezzo (€)
● 2731101	0150B400CR	1/2"	3/8"	piana	10	NR	2	100	06	6,52

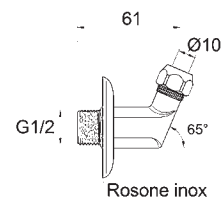

CURVETTA ESAGONALE 45° STAMPATA SENZA CALOTTA



codice	sigla	attacco muro	uscita	UM	min. ord.	conf.	cat.	prezzo (€)
● 2731105	01500400CR	1/2"	3/8"	NR	2	100	06	5,72

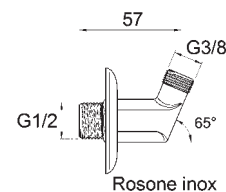

CURVETTA 90° STAMPATA CALOTTA BASSA



codice	sigla	attacco muro	uscita	battuta	calotta Ø	UM	min. ord.	conf.	cat.	prezzo (€)
● 2731106	0160SB400CR	1/2"	3/8"	piana	10	NR	2	100	06	8,57

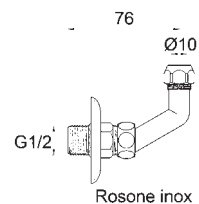

CURVETTA 90° IN TUBO DI RAME CROMATO CALOTTA BASSA



codice	sigla	attacco muro	uscita	battuta	calotta Ø	UM	min. ord.	conf.	cat.	prezzo (€)
● 2731102	0160B400CR	1/2"	3/8"	piana	10	NR	2	100	06	8,57

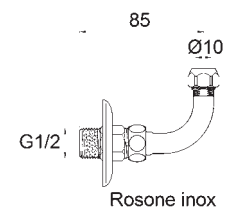

CURVETTA SNODATA CALOTTA BASSA



codice	sigla	attacco muro	uscita	battuta	calotta Ø	UM	min. ord.	conf.	cat.	prezzo (€)
● 2731103	0172B400CR	1/2"	3/8"	piana	10	NR	2	100	06	9,79

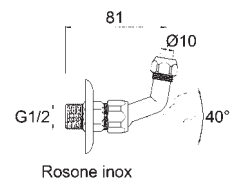

RUBINETTERIA SOTTOLAVABO, LAVATRICE E VARIA

RUBINETTI PER CASSETTA WC

RUBINETTO MASCHIO PER CASSETTA WC

Chiusura a vitone con codolo e calotta girevole



codice	sigla	attacco Ø	UM	min. ord.	conf.	cat.	prezzo (€)
● 2733002	0500C300CR	3/8"x3/8"	NR	1	50	06	10,94
● 2733001	0500C400CR	1/2"x3/8"	NR	1	50	06	11,34

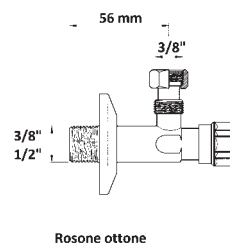

Rosone ottone

RUBINETTO FEMMINA PER CASSETTA WC

Chiusura a vitone con codolo e calotta girevole



codice	sigla	attacco Ø	UM	min. ord.	conf.	cat.	prezzo (€)
● 2733000	0509C300CR	3/8"x3/8"	NR	1	50	06	9,29

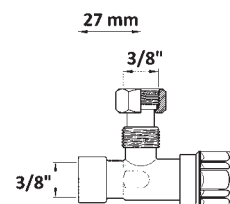

RUBINETTO MASCHIO PER CASSETTA WC CON TUBO

Chiusura a vitone con tubetto in rame cromato D.10



codice	sigla	attacco Ø	UM	min. ord.	conf.	cat.	prezzo (€)
● 2733003	05050300CR	3/8"x3/8"	NR	1	25	06	13,39
● 2733004	05050400CR	1/2"x3/8"	NR	1	25	06	13,61

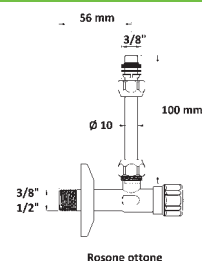

Rosone ottone

RUBINETTO MASCHIO PER CASSETTA WC CON TUBI

Chiusura a vitone, con tubetti in rame cromato D.10 lunghi 15 cm



codice	sigla	attacco Ø	UM	min. ord.	conf.	cat.	prezzo (€)
● 2733005	05070300CR	3/8"x3/8"	NR	1	20	06	19,98

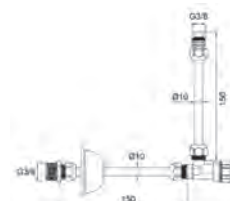

RACCORDI PER SCALDABAGNO

RACCORDI PER SCALDABAGNO

Con tubi e squadretta in rame cromato, biconi D. 14



codice	sigla	attacco Ø	UM	min. ord.	conf.	cat.	prezzo (€)
● 2733010	0905R442CR	1/2"x1/2"	NR	1	06	06	52,38

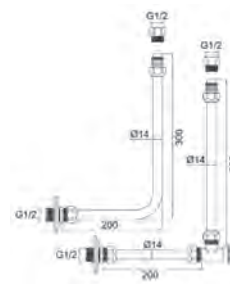

COMPLEMENTI
SANITARI

RUBINETTERIA SOTTOLAVABO, LAVATRICE E VARIA

LAVATRICE E SOTTOLAVELLO

RUBINETTO 5 VIE SENZA FILTRO



Chiusure a vitoni indipendenti

codice	sigla	attacco Ø	calotta Ø	UM	min. ord.	conf.	cat.	prezzo (€)
● 2730251	0550S400CR	1/2"x3/4"	10	NR	1	50	06	25,67

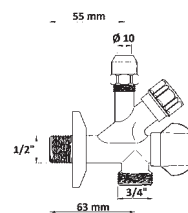

RUBINETTO 5 VIE CON FILTRO



Chiusure a vitoni indipendenti

codice	sigla	attacco Ø	calotta Ø	UM	min. ord.	conf.	cat.	prezzo (€)
● 2730252	0551B400CR	1/2"x3/4"	10	NR	1	50	06	33,05

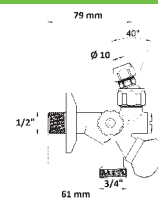

RUBINETTO LAVATRICE CHIUSURA A SFERA



Maniglia metallica

codice	sigla	attacco Ø	UM	min. ord.	conf.	cat.	prezzo (€)
● 2732005	05550300CR	3/8"x3/4"	NR	1	100	06	10,80
● 2732001	05550400CR	1/2"x3/4"	NR	100	100	06	10,69

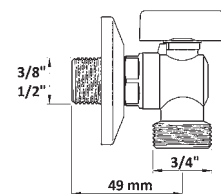

RUBINETTO LAVATRICE CHIUSURA A SFERA CORPO LUNGO



Maniglia plastica

codice	sigla	attacco Ø	UM	min. ord.	conf.	cat.	prezzo (€)
● 2732008	0552L400CR	1/2"x3/4"	NR	1	50	06	14,11

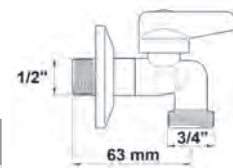

RUBINETTO LAVATRICE CHIUSURA A VITONE



codice	sigla	attacco Ø	UM	min. ord.	conf.	cat.	prezzo (€)
● 2732004	05580400CR	1/2"x3/4"	NR	1	100	06	11,56

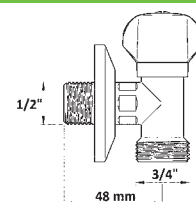

RUBINETTO LAVATRICE 3 VIE, CHIUSURA A VITONE



codice	sigla	attacco Ø	UM	min. ord.	conf.	cat.	prezzo (€)
● 2732003	05590400CR	1/2"x3/4"	NR	1	100	06	14,11

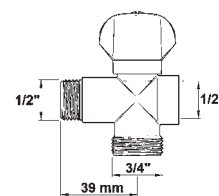

RUBINETTO LAVATRICE 3 VIE CON DISTANZIATORE



codice	sigla	attacco Ø	UM	min. ord.	conf.	cat.	prezzo (€)
● 2732006	05540500CR	3/4"x3/4"	NR	1	50	06	20,34

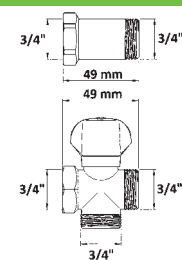

TUBO CARICO LAVATRICE

Tubo flessibile DN 13 in acciaio inox AISI 304 con raccordi femmina e guarnizioni inserite. Temperatura 90°C. Pressione max 10 bar



codice	Ø	lunghezza (mm)	UM	min. ord. conf.	cat.	prezzo (€)
● 2862914	3/4"	1500	NR	1	06	22,05
● 2862915	3/4"	2000	NR	1	06	25,71

TUBO CARICO LAVATRICE CON CURVA

Tubo DN 8 in acciaio inox femmina e femmina curva con guarnizione inserita in entrambi i lati. Temperatura 70°C. Pressione max 10 bar



codice	sigla	Ø	lung. (mm)	UM	min. ord. conf.	cat.	prezzo (€)
● 2862701	CGGHZS1000LAN	3/4"	1000	NR	10	06	17,42
● 2862702	CGGHZS1500LAN	3/4"	1500	NR	10	06	16,99
● 2862703	CGGHZS2000LAN	3/4"	2000	NR	10	06	18,97

TUBO CARICO LAVATRICE

Tubo DN 10 in nylon con guarnizione inserita in entrambi i lati



codice	Ø	lunghezza (mm)	UM	min. ord. conf.	cat.	prezzo (€)
● 2880001	FF 3/4"	1000	NR	1	09	5,01
● 2880002	FF 3/4"	1500	NR	1	09	6,09
● 2880003	FF 3/4"	2000	NR	1	09	7,17
● 2880005	FF 3/4"	3000	NR	1	09	9,35

TUBO CARICO LAVATRICE CON CURVA

Tubo DN 10 in nylon con guarnizione inserita in entrambi i lati



codice	Ø	lunghezza (mm)	UM	min. ord. conf.	cat.	prezzo (€)
● 2881001	FF 3/4"	1000	NR	1	09	5,01
● 2881002	FF 3/4"	1500	NR	1	09	6,09
● 2881003	FF 3/4"	2000	NR	1	09	7,17
● 2881004	FF 3/4"	2500	NR	1	09	8,46

TUBO SCARICO LAVATRICE

In polipropilene con curva, tubo D.19x25, manicotti D.19x22



codice	Ø	lunghezza (mm)	UM	min. ord. conf.	cat.	prezzo (€)
● 2882001	19x25	1000	NR	1	09	3,59
● 2882002	19x25	1500	NR	1	09	3,72
● 2882003	19x25	2000	NR	1	09	4,20
● 2882004	19x25	2500	NR	1	09	4,76
● 2882005	19x25	3000	NR	1	09	5,24

TUBO SCARICO LAVATRICE ESTENSIBILE

Con morsetti in gomma. Passaggio D. 19

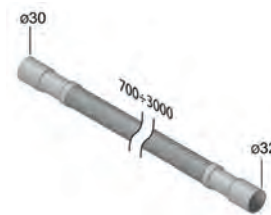

codice	sigla	lunghezza (mm)	UM	min. ord. conf.	cat.	prezzo (€)
● 2883001	-485.309.6.	700-3000	NR	1	20	7,92

SIFONE AD INCASSO PER LAVATRICE

In PeHD, con protezione



RICAMBI (PAG. 206)

2661013 - Piastra inox
2661014 - Piastra ABS
2661017 - Curvetta

codice	attacco Ø	piastra	UM	min. ord.	conf.	cat.	prezzo (€)
● 2401201	1" x 40-50	acciaio inox	NR	1	30	02	14,31
● 2401301	1" x 40-50	ABS bianca	NR	1	30	02	12,95

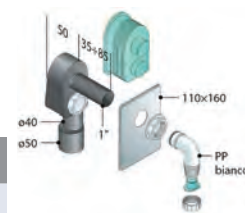

SIFONE AD INCASSO PER LAVATRICE E ASCIUGATRICE O CONDIZIONAMENTO

Sifone ad incasso con doppia entrata per lavatrice e asciugatrice o scarico condensa condizionatore. In PP, con protezione, attacco lavatrice amovibile e richiudibile, attacco condensa e asciugatrice amovibile e richiudibile con valvola di non ritorno. Uscita D.40, piastra in ABS bianco 130x85.



codice	sigla	attacco lavatrice	attacco asciug/conden.	UM	min. ord.	conf.	cat.	prezzo (€)
● 2401202	2207.512.6.	1" x 21	1" x 10/14	NR	1	30	02	35,70

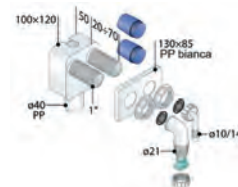

NOVITÀ!

RUBINETTERIA SOTTOLAVABO, LAVATRICE E VARIA

LAVATRICE E SOTTOLAVELLO

SIFONE ESTERNO PER LAVATRICE

In ottone cromato, ispezionabile.



codice	sigla	attacco Ø	UM	min. ord.	conf.	cat.	prezzo (€)
● 2401305	93733400	32	NR	2	20	02	24,62

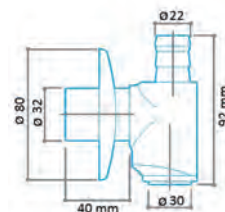

VALVOLA ESTERNA PER LAVATRICE

In PP. Con molla antiritorno che permette alla valvola di funzionare in tutte le posizioni.



codice	sigla	attacco Ø	UM	min. ord. conf.	cat.	prezzo (€)
● 2401304	2108.180.5.	32	NR	10	02	7,92

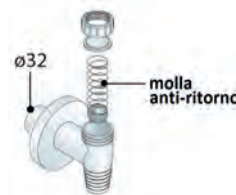

CURVETTA IN ABS ATTACCO LAVATRICE CURVO

Con ghiera e guarnizione



codice	Ø	UM	min. ord. conf.	cat.	prezzo (€)
● 2661086	1"	NR	10	20	6,42

CURVETTA IN PP ATTACCO LAVATRICE CURVO



codice	sigla	Ø	UM	min. ord. conf.	cat.	prezzo (€)
● 2661017	2111.100.4.	1"	NR	10	20	3,43

PIPA CON GHIERA GIREVOLE IN PVC



codice	Ø	UM	min. ord. conf.	cat.	prezzo (€)
● 2661091	3/4" x 3/4"	NR	10	23	8,40

ATTACCO DOPPIO X TUBO CARICO LAVATRICE



codice	Ø	UM	min. ord. conf.	cat.	prezzo (€)
● 2661092	3/4" F x 3/4" M x 3/4" M	NR	10	20	6,60

NIPPLE IN ABS



codice	Ø	UM	min. ord. conf.	cat.	prezzo (€)
● 2661087	3/4"	NR	10	23	1,08

GIUNTO PER TUBO



codice	Ø	UM	min. ord. conf.	cat.	prezzo (€)
● 2661089	17x17	NR	1	23	0,96
● 2661090	17x22	NR	1	23	0,96
● 2661088	22x22	NR	1	23	0,96

GIUNTO A DUE VIE X TUBO SCARICO LAVATRICE



codice	Ø	UM	min. ord. conf.	cat.	prezzo (€)
● 2661093	20x20x20	NR	10	20	3,21

PIASTRA PER SIFONE LAVATRICE AD INCASSO

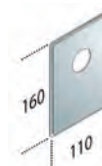

codice	sigla	descrizione	UM	min. ord. conf.	cat.	prezzo (€)
● 2661013	-137.074.0.	Inox	NR	10	20	4,80
● 2661014	-137.075.0.	ABS bianca	NR	10	20	2,95

FLESSIBILI ACQUA E ANTIVIBRANTI

FLESSIBILI RUBINETTERIA

Tubi flessibili in acciaio inox AISI 304, tubo interno in EPDM, raccordi in ottone.
Temperatura max 70°C. Pressione max 10 bar.

FLESSIBILE MASCHIO CORTO

Con maschio corto e femmina girevole, con guarnizione inserita.
APPLICAZIONE: Rubinetti tradizionali, rubinetti miscelatori.



codice	sigla	DN	FGI	MC	mm	UM	min. ord. conf.	cat.	prezzo (€)
● 2870011	-	6	3/8"	8x1	350	NR	25	06	4,36
● 2870003	CGAKLS0300LAL	8	3/8"	10x1	300	NR	25	06	4,18
● 2870004	-	8	3/8"	10x1	350	NR	25	06	4,46
● 2870005	CGAKLS0400LAE	8	3/8"	10x1	400	NR	10	06	4,46
● 2870006	CGAKLS0500LAE	8	3/8"	10x1	500	NR	10	06	4,86
● 2870012	-	8	3/8"	11x1	350	NR	25	06	4,73
● 2870013	-	8	3/8"	12x1	350	NR	25	06	4,84

FLESSIBILE RACCORDO A COMPRESSIONE

Con raccordo a compressione con cartuccia 3 pezzi e astina con scalino
APPLICAZIONE: Rubinetti tradizionali, rubinetti miscelatori.



codice	sigla	TS	RCC	mm	UM	min. ord. conf.	cat.	prezzo (€)
● 2872002	CGA3GS0250LAL	10	10	250	NR	25	06	7,63

FLESSIBILE MASCHIO MEDIO

Con maschio medio e femmina girevole, con guarnizione inserita.
APPLICAZIONE: Rubinetti tradizionali, rubinetti miscelatori.



codice	sigla	FGI	MM	mm	UM	min. ord. conf.	cat.	prezzo (€)
● 2873004	CGASES0350LAL	3/8"	10x1	350	NR	25	06	6,62
● 2873005	CGASES0400LAE	3/8"	10x1	400	NR	10	06	6,73

FLESSIBILI ACQUA DN8

FLESSIBILE FEMMINA RACCORDO A COMPRESSIONE

Con raccordo femmina e raccordo a compressione con cartuccia a 3 pezzi, con guarnizione inserita.
APPLICAZIONE: Cassette di scarico, caldaie, installazioni generiche.



codice	sigla	FGI	RCC	mm	UM	min. ord. conf.	cat.	prezzo (€)
● 2804503	CGANWS0300LAL	3/8"	10	300	NR	25	06	7,74

FLESSIBILE FEMMINA - FEMMINA

Con raccordo femmina girevole, con guarnizione inserita, in entrambi i lati.
APPLICAZIONE: Cassette di scarico, caldaie, installazioni generiche.



codice	sigla	FGI	FGI	mm	UM	min. ord. conf.	cat.	prezzo (€)
● 2801102	CGAGUS0250LAL	3/8"	3/8"	250	NR	25	06	4,68
● 2801103	CGAGUS0300LAL	3/8"	3/8"	300	NR	25	06	4,82
● 2801104	CGAGUS0350LAL	3/8"	3/8"	350	NR	25	06	5,04

FLESSIBILE FEMMINA - FEMMINA CURVA

Con femmina e femmina curva con guarnizione inserita.
APPLICAZIONE: Lavatrice, lavastoviglie.



codice	sigla	FGI	FCGI	mm	UM	min. ord. conf.	cat.	prezzo (€)
● 2862701	CGGHZS1000LAN	3/4"	3/4"	1000	NR	10	06	17,42
● 2862702	CGGHZS1500LAN	3/4"	3/4"	1500	NR	10	06	16,99
● 2862703	CGGHZS2000LAN	3/4"	3/4"	2000	NR	10	06	18,97

FLESSIBILE MASCHIO PROLUNGATO RACCORDO A COMPRESSIONE

Con raccordo maschio prolungato e raccordo a compressione con cartuccia 3 pezzi.
APPLICAZIONE: Cassette di scarico, caldaie, installazioni generiche.



codice	sigla	MP	RCC	mm	UM	min. ord. conf.	cat.	prezzo (€)
● 2804201	CGAQPS0200LAL	1/2"	10	200	NR	25	06	8,53
● 2804202	CGAQPS0250LAL	1/2"	10	250	NR	25	06	7,16
● 2804203	CGAQPS0300LAL	1/2"	10	300	NR	25	06	7,27
● 2804204	CGAQPS0350LAL	1/2"	10	350	NR	25	06	7,49
● 2804205	CGAQPS0400LAE	1/2"	10	400	NR	10	06	9,14

LEGENDA

F: FEMMINA GUARNIZIONE INSERITA

FCGI: FEMMINA CURVA GUARNIZIONE INSERITA

FGI: FEMMINA GUARNIZIONE INSERITA CON DADO GIREVOLE

M: MASCHIO

MC: MASCHIO CORTO

MM: MASCHIO MEDIO

MP: MASCHIO PROLUNGATO

MPR: MASCHIO PROLUNGATO CON ROSETTA

RCC: RACCORDO A COMPRESSIONE

TS: DIAMETRO ASTINA CON SCALINO

FLESSIBILI ACQUA E ANTIVIBRANTI

FLESSIBILI ACQUA DN10

Tubi flessibili in acciaio inox AISI 304, tubo interno in EPDM, raccordi in ottone.
Temperatura max 70°C. Pressione max 10 bar.

FLESSIBILE FEMMINA - FEMMINA

Con raccordo femmina girevole, con guarnizione inserita in entrambi i lati.

APPLICAZIONE: Cassette di scarico, caldaie, installazioni generiche.



codice	sigla	FGI	FGI	mm	UM	min. ord. conf.	cat.	prezzo (€)
● 2811101	-	3/8"	3/8"	200	NR	25	06	4,97
● 2811102	-	3/8"	3/8"	250	NR	25	06	5,04
● 2811103	-	3/8"	3/8"	300	NR	25	06	5,22
● 2811104	FGAGUS0350LAL	3/8"	3/8"	350	NR	25	06	5,40
● 2811105	FGAGUS0400LAE	3/8"	3/8"	400	NR	10	06	5,54
● 2811106	FGAGUS0500LAE	3/8"	3/8"	500	NR	10	06	5,94
● 2811201	FGAGNS0200LAL	1/2"	3/8"	200	NR	25	06	5,08
● 2811202	FGAGNS0250LAL	1/2"	3/8"	250	NR	25	06	5,26
● 2811203	-	1/2"	3/8"	300	NR	25	06	5,54
● 2811204	FGAGNS0350LAL	1/2"	3/8"	350	NR	25	06	5,65
● 2811205	FGAGNS0400LAE	1/2"	3/8"	400	NR	10	06	5,76
● 2811301	FGAGKS0200LAL	1/2"	1/2"	200	NR	25	06	5,40
● 2811302	FGAGKS0250LAL	1/2"	1/2"	250	NR	25	06	5,58
● 2811303	-	1/2"	1/2"	300	NR	25	06	5,80
● 2811304	FGAGKS0350LAL	1/2"	1/2"	350	NR	25	06	5,51
● 2811305	FGAGKS0400LAE	1/2"	1/2"	400	NR	10	06	6,05
● 2811306	FGAGKS0500LAE	1/2"	1/2"	500	NR	10	06	6,48
● 2811309	FGAGKS1000LAE	1/2"	1/2"	1000	NR	10	06	8,42

FLESSIBILE MASCHIO PROLUNGATO CON ROSETTA - FEMMINA

Con raccordo maschio prolungato con rosetta scorrevole e raccordo femmina girevole, con guarnizione inserita.

APPLICAZIONE: Cassette di scarico, caldaie, installazioni generiche.



codice	sigla	MPR	FGI	mm	UM	min. ord. conf.	cat.	prezzo (€)
● 2812101	-	3/8"	3/8"	200	NR	25	06	5,54
● 2812102	-	3/8"	3/8"	250	NR	25	06	5,69
● 2812103	-	3/8"	3/8"	300	NR	25	06	5,90
● 2812104	FGADJ0350LAR	3/8"	3/8"	350	NR	25	06	6,05
● 2812105	FGADJ0400LAS	3/8"	3/8"	400	NR	10	06	6,19
● 2812106	FGADJ0500LAS	3/8"	3/8"	500	NR	10	06	6,59
● 2812302	FGADES0250LAR	1/2"	3/8"	250	NR	25	06	6,26
● 2812303	FGADES0300LAR	1/2"	3/8"	300	NR	25	06	6,44
● 2812305	FGADES0400LAS	1/2"	3/8"	400	NR	10	06	6,73
● 2812401	FGADDS0200LAR	1/2"	1/2"	200	NR	25	06	6,37
● 2812402	-	1/2"	1/2"	250	NR	25	06	6,66
● 2812403	-	1/2"	1/2"	300	NR	25	06	6,73
● 2812404	-	1/2"	1/2"	350	NR	25	06	7,02
● 2812405	-	1/2"	1/2"	400	NR	10	06	7,13
● 2812406	FGADDS0500LAS	1/2"	1/2"	500	NR	10	06	7,49
● 2812409	-	1/2"	1/2"	1000	NR	10	06	9,47

FLESSIBILE MASCHIO - FEMMINA

Con raccordo maschio e raccordo femmina girevole, con guarnizione inserita.

APPLICAZIONE: Cassette di scarico, caldaie, installazioni generiche.



codice	sigla	M	FGI	mm	UM	min. ord. conf.	cat.	prezzo (€)
● 2810101	-	3/8"	3/8"	200	NR	25	06	4,64
● 2810102	-	3/8"	3/8"	250	NR	25	06	4,79
● 2810103	-	3/8"	3/8"	300	NR	25	06	4,97
● 2810104	-	3/8"	3/8"	350	NR	25	06	5,15
● 2810105	-	3/8"	3/8"	400	NR	10	06	5,18
● 2810106	FGACFS0500LAE	3/8"	3/8"	500	NR	10	06	5,65
● 2810107	FGACFS0600LAE	3/8"	3/8"	600	NR	10	06	6,01
● 2810109	FGACFS1000LAE	3/8"	3/8"	1000	NR	10	06	7,56
● 2810201	FGACDS0200LAL	3/8"	1/2"	200	NR	25	06	4,79
● 2810202	FGACDS0250LAL	3/8"	1/2"	250	NR	25	06	4,97
● 2810203	FGACDS0300LAL	3/8"	1/2"	300	NR	25	06	5,15
● 2810204	FGACDS0350LAL	3/8"	1/2"	350	NR	25	06	5,36
● 2810205	FGACDS0400LAE	3/8"	1/2"	400	NR	10	06	5,54
● 2810206	FGACDS0500LAE	3/8"	1/2"	500	NR	10	06	5,90
● 2810301	FGAAVS0200LAL	1/2"	3/8"	200	NR	25	06	4,86
● 2810302	FGAAVS0250LAL	1/2"	3/8"	250	NR	25	06	5,04
● 2810303	FGAAVS0300LAL	1/2"	3/8"	300	NR	25	06	5,22
● 2810304	FGAAVS0350LAL	1/2"	3/8"	350	NR	25	06	5,47
● 2810305	FGAAVS0400LAE	1/2"	3/8"	400	NR	10	06	5,58
● 2810401	-	1/2"	1/2"	200	NR	25	06	5,22
● 2810402	-	1/2"	1/2"	250	NR	25	06	5,47
● 2810403	-	1/2"	1/2"	300	NR	25	06	5,58
● 2810404	-	1/2"	1/2"	350	NR	25	06	5,80
● 2810405	-	1/2"	1/2"	400	NR	10	06	5,87
● 2810406	-	1/2"	1/2"	500	NR	10	06	6,30
● 2810407	FGAASS0600LAE	1/2"	1/2"	600	NR	10	06	6,70
● 2810408	FGAASS0800LAE	1/2"	1/2"	800	NR	10	06	9,00
● 2810409	-	1/2"	1/2"	1000	NR	10	06	8,24

FLESSIBILE MASCHIO PROLUNGATO RACCORDO A COMPRESSIONE

Con raccordo maschio prolungato e raccordo a compressione con cartuccia a 3 pezzi.

APPLICAZIONE: Cassette di scarico, caldaie, installazioni generiche.



codice	sigla	MP	RCC	mm	UM	min. ord. conf.	cat.	prezzo (€)
● 2814202	FGAQPS0250LAL	1/2"	10	250	NR	25	06	7,09
● 2814203	-	1/2"	10	300	NR	25	06	7,38
● 2814204	FGAQPS0350LAL	1/2"	10	350	NR	25	06	8,96

LEGENDA

F: FEMMINA GUARNIZIONE INSERITA
FCGI: FEMMINA CURVA GUARNIZIONE INSERITA
FGI: FEMMINA GUARNIZIONE INSERITA CON DADO GIREVOLE

M: MASCHIO
MC: MASCHIO CORTO
MM: MASCHIO MEDIO
MP: MASCHIO PROLUNGATO

MPR: MASCHIO PROLUNGATO CON ROSETTA
RCC: RACCORDO A COMPRESSIONE
TS: DIAMETRO ASTINA CON SCALINO

FLESSIBILI ACQUA E ANTIVIBRANTI

FLESSIBILI ACQUA DN10

FLESSIBILE FEMMINA RACCORDO A COMPRESSIONE

Con raccordo femmina e raccordo a compressione con cartuccia a 3 pezzi, con guarnizione.

APPLICAZIONE: Cassette di scarico, caldaie, installazioni generiche.



codice	sigla	FGI	RCC	mm	UM	min. ord. conf.	cat.	prezzo (€)
● 2814502	FGANWS0250LAL	3/8"	10	250	NR	25	06	8,21
● 2814503	FGANWS0300LAL	3/8"	10	300	NR	25	06	8,42

FLESSIBILE MASCHIO RACCORDO A COMPRESSIONE

Con raccordo maschio e raccordo a compressione con cartuccia a 3 pezzi.

APPLICAZIONE: Cassette di scarico, caldaie, installazioni generiche.



codice	sigla	M	RCC	mm	UM	min. ord. conf.	cat.	prezzo (€)
● 2815201	FGAQES0200LAL	1/2"	10	200	NR	25	06	7,74
● 2815202	FGAQES0250LAL	1/2"	10	250	NR	25	06	7,92
● 2815203	FGAQES0300LAL	1/2"	10	300	NR	25	06	8,14

FLESSIBILE MASCHIO - FEMMINA

Tubo flessibile in acciaio inox AISI 304 con raccordo maschio e raccordo femmina girevole, con guarnizione inserita.

Temperatura max 70°C. Pressione max 10 bar.

APPLICAZIONE: Scaldabagni, cabine doccia, vasche idromassaggio, fan coil, installazioni generiche.



codice	sigla	M	FGI	mm	UM	min. ord. conf.	cat.	prezzo (€)
● 2820102	MGAASS0250LAL	1/2"	1/2"	250	NR	25	06	9,29
● 2820103	MGAASS0300LAL	1/2"	1/2"	300	NR	25	06	9,72
● 2820105	MGAASS0400LAE	1/2"	1/2"	400	NR	10	06	10,66

FLESSIBILE FEMMINA-FEMMINA

Tubo flessibile in acciaio inox AISI 304 con raccordi femmina e guarnizioni inserite.

Temperatura max 90°C. Pressione max 10 bar.

APPLICAZIONE: Lavatrice e lavastoviglie.



codice	FGI	mm	UM	min. ord. conf.	cat.	prezzo (€)
● 2862914	3/4"	1500	NR	1	06	22,05
● 2862915	3/4"	2000	NR	1	06	25,71

ANTIVIBRANTI

Tubi flessibili in acciaio zincato, tubo interno in EPDM.

Temperatura max 110°C. Pressione max 15 bar (DN 15-25), 6 bar (DN 32-50)

FLESSIBILI ANTIVIBRANTI ZINCATI MASCHIO-FEMMINA

Con raccordo maschio e raccordo femmina in ottone nichelato.

APPLICAZIONE: Pompe, Impianti di riscaldamento, colonne montanti, applicazioni generiche.



RACCORDI IN OTTONE

codice	MF	DN	mm	UM	min. ord. conf.	cat.	prezzo (€)
● 2862101	1/2"	13	300	NR	5	21	8,67
● 2862102	1/2"	13	400	NR	5	21	9,49
● 2862103	1/2"	13	500	NR	5	21	10,26
● 2862104	1/2"	13	600	NR	5	21	11,07
● 2862106	1/2"	13	800	NR	5	21	12,66
● 2862107	1/2"	13	1000	NR	5	21	14,17
● 2862201	3/4"	19	300	NR	5	21	14,87
● 2862202	3/4"	19	400	NR	5	21	15,76
● 2862203	3/4"	19	500	NR	5	21	17,34
● 2862204	3/4"	19	600	NR	5	21	18,54
● 2862206	3/4"	19	800	NR	5	21	21,01
● 2862207	3/4"	19	1000	NR	5	21	23,42
● 2862301	1"	25	300	NR	5	21	20,69
● 2862302	1"	25	400	NR	5	21	22,28
● 2862303	1"	25	500	NR	5	21	23,86
● 2862304	1"	25	600	NR	5	21	25,44
● 2862306	1"	25	800	NR	5	21	28,48
● 2862307	1"	25	1000	NR	5	21	31,64

codice	MF	DN	mm	UM	min. ord. conf.	cat.	prezzo (€)
● 2862401	1"1/4	32	300	NR	2	21	42,66
● 2862402	1"1/4	32	400	NR	2	21	45,37
● 2862403	1"1/4	32	500	NR	2	21	48,10
● 2862404	1"1/4	32	600	NR	2	21	50,82
● 2862406	1"1/4	32	800	NR	2	21	56,26
● 2862407	1"1/4	32	1000	NR	2	21	61,89
● 2862502	1"1/2	40	400	NR	2	21	61,83
● 2862503	1"1/2	40	500	NR	2	21	65,75
● 2862504	1"1/2	40	600	NR	2	21	69,68
● 2862602	2"	50	400	NR	1	21	101,06
● 2862603	2"	50	500	NR	1	21	106,07

LEGENDA

F: FEMMINA GUARNIZIONE INSERITA

FCGI: FEMMINA CURVA GUARNIZIONE INSERITA

FGI: FEMMINA GUARNIZIONE INSERITA CON DADO GIREVOLE

M: MASCHIO

MC: MASCHIO CORTO

MM: MASCHIO MEDIO

MP: MASCHIO PROLUNGATO

MPR: MASCHIO PROLUNGATO CON ROSETTA

RCC: RACCORDO A COMPRESSIONE

TS: DIAMETRO ASTINA CON SCALINO

SISTEMI DI FISSAGGIO

STAFFE PER SANITARI SOSPESI

STAFFA WC E BIDET SOSPESI MOD. UNIVERSALE



Sistema universale per vasi e bidet sospesi, con alloggiamento per tubo di cacciata. SMONTATA.

codice	interasse (mm)	UM	min. ord. conf.	cat.	prezzo (€)
● 5850002	180-230	NR	1	06	37,73

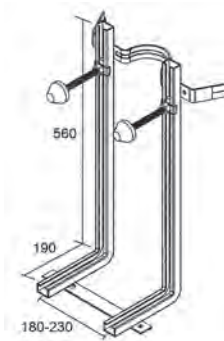

STAFFA BIDET SOSPESO MOD. COMBI



codice	interasse (mm)	UM	min. ord. conf.	cat.	prezzo (€)
● 5850031	180-230	NR	1	09	118,24

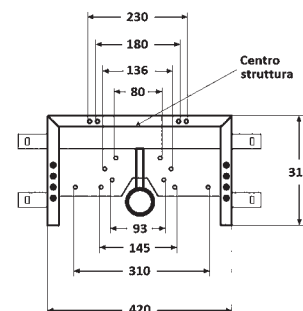

SUPPORTI E FISSAGGI

SUPPORTO REGOLABILE PER PILOZZI, VERNICIATO BIANCO

Confezione 2 pezzi



codice	dimensioni (mm)	tassello (mm)	UM	min. ord.	conf.	cat.	prezzo (€)
● 5863001	12x340	16x90	CF	1	10	09	29,92
● 5863002	12x460	16x90	CF	1	10	09	36,32

FISSAGGIO LATERALE WC E BIDET MULTIFORO

In nylon.
Confezione 2 pezzi



codice	tassello (mm)	UM	min. ord.	conf.	cat.	prezzo (€)
● 5863101	M10x50	CF	1	100	09	5,44

FISSAGGIO VERTICALE WC E BIDET

Vite in acciaio inox, dado in ottone nichelato.
Confezione 4 pezzi



codice	dimensioni (mm)	tassello (mm)	UM	min. ord.	conf.	cat.	prezzo (€)
● 5863401	M6x80	8x40	CF	1	100	09	5,52

FISSAGGIO LAVABO

Dado in acciaio, tassello doppia espansione.
Confezione 2 pezzi



codice	dimensioni (mm)	tassello (mm)	UM	min. ord.	conf.	cat.	prezzo (€)
● 5863201	M10x115	14x60	CF	1	50	09	2,80

FISSAGGIO SCALDABAGNO E CALDAIA

Con tassello doppia espansione per pareti vuote.
Confezione 2 pezzi



codice	dimensioni (mm)	tassello (mm)	UM	min. ord.	conf.	cat.	prezzo (€)
● 5863301	M10x94	14x60	CF	1	50	09	3,60

SANITRIT UP

Trituratore adattabile a tutti i wc tradizionali in ceramica.
A corredo: valvola clapet, kit di raccordo impianto e filtro a carboni attivi, per neutralizzare gli odori.



Applicazioni: WC

Capacità di scarico: 4 metri in verticale (tubo Ø 22/28/32 mm.)
100 metri in orizzontale (tubo Ø 28/32/40 mm.)

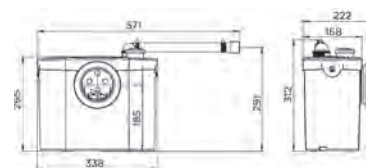

codice	sigla	Nr. entrate	Livello sonoro	UM	min. ord. conf.	cat.	prezzo (€)
● 3350100	STSUP	1	46 dB(A)	NR	1	17	900,80

SANITOP UP

Trituratore adattabile a tutti i wc tradizionali in ceramica, con la possibilità di collegare anche un lavabo. A corredo: valvola clapet, kit di raccordo impianto e filtro a carboni attivi, per neutralizzare gli odori.



Applicazioni: WC - lavabo

Capacità di scarico: 5 metri in verticale (tubo Ø 22/28/32 mm.)
100 metri in orizzontale (tubo Ø 22/28/40 mm.)

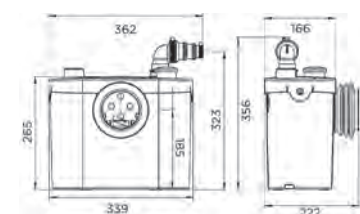

codice	sigla	Nr. entrate	Livello sonoro	UM	min. ord. conf.	cat.	prezzo (€)
● 3350060	SPSUP	2	46 dB(A)	NR	1	17	1.008,44

SANISLIM

Trituratore con profondità ridotta, con la possibilità di collegare un bagno completo (escluso lavatrice). A corredo: valvola clapet, kit di raccordo impianto e filtro a carboni attivi, per neutralizzare gli odori.



Applicazioni: WC - lavabo - bidet - doccia

Capacità di scarico: 4 metri in verticale (tubo Ø 22/28/32 mm.)
40 metri in orizzontale (tubo Ø 22/28/32 mm.)

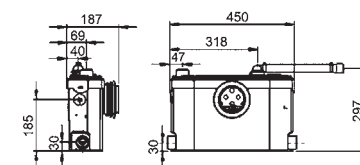

codice	sigla	Nr. entrate	Livello sonoro	UM	min. ord. conf.	cat.	prezzo (€)
● 3350080	SSL	4	46 dB(A)	NR	1	17	1.165,66

SANIPLUS UP

Trituratore con ampio serbatoio, con la possibilità di collegare un bagno completo (escluso lavatrice). A corredo: valvola clapet, kit di raccordo impianto e filtro a carboni attivi, per neutralizzare gli odori.



Applicazioni: WC - lavabo - bidet - doccia

Capacità di scarico: 5 metri in verticale (tubo Ø 22/28/32 mm.)
100 metri in orizzontale (tubo Ø 28/32/40 mm.)

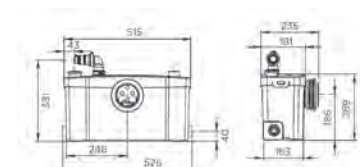

codice	sigla	Nr. entrate	Livello sonoro	UM	min. ord. conf.	cat.	prezzo (€)
● 3350090	SSSUP	4	46 dB(A)	NR	1	17	1.335,62

TRITURATORI E POMPE SOLLEVAMENTO

TRITURATORI

SANIPACK PRO UP

Trituratore ad incasso per wc sospesi, con la possibilità di collegare un bagno completo (escluso lavatrice). A corredo: valvola clapet, connettori e filtro a carboni attivi, per neutralizzare gli odori.



Applicazioni: WC - WC sospeso - lavabo - bidet - doccia
Capacità di scarico: 5 metri in verticale (tubo Ø 22/28/32 mm.)
 100 metri in orizzontale (tubo Ø 28/32/40 mm.)

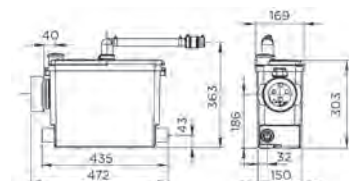

codice	sigla	Nr. entrate	Livello sonoro	UM	min. ord. conf.	cat.	prezzo (€)
● 3350050	SKUP	4	47 dB(A)	NR	1	17	1.212,40

SANICOMPACT 43 SILENCE

WC in ceramica con tritatore incorporato, sedile antibatterico a chiusura rallentata. Non necessita di cassetta di scarico, in quanto dotato di meccanismo di risciacquo con doppio scarico da 1,8 a 3 litri. Ultracompatto: 43 cm profondità. A corredo: valvola clapet, fissaggi a terra.



Applicazioni: WC - lavabo
Capacità di scarico: 3 metri in verticale (tubo Ø 32 mm.)
 30 metri in orizzontale (tubo Ø 32/40 mm.)



codice	sigla	Nr. entrate	Livello sonoro	UM	min. ord. conf.	cat.	prezzo (€)
● 3350001	CPT43LS	1	51 dB(A)	NR	1	17	1.621,73

SANICOMPACT LUXE SILENCE

WC in ceramica dal design classico con tritatore incorporato, sedile antibatterico. Non necessita di cassetta di scarico in quanto è dotato di meccanismo di risciacquo con doppio scarico da 1,8 a 3 litri. A corredo: valvola clapet, fissaggi a terra.



Applicazioni: WC - lavabo
Capacità di scarico: 3 metri in verticale (tubo Ø 32 mm.)
 30 metri orizzontale (tubo Ø 32/40 mm.)



codice	sigla	Nr. entrate	Livello sonoro	UM	min. ord. conf.	cat.	prezzo (€)
● 3550003	CPTLS	1	51 dB(A)	NR	1	17	1.621,72

LIQUIDO ANTICALCARE PER TRITURATORI

Anticalcare specifico per tritatori, sgrassante e disinfettante. Non è un disotturante.



codice	sigla	descrizione	UM	min. ord.	conf.	cat.	prezzo (€)
● 3350503	ANTICALC	Tanica 5 litri	NR	1	2	17	56,65

SANISHOWER PLUS+

Pompa e sifone per piatto doccia classico. Possibilità di collegare anche un lavabo o un bidet. A corredo: valvola clapet, filtro a carboni attivi, per neutralizzare gli odori.

Applicazioni: lavabo - cabina doccia - bidet - addolcitore acqua
Capacità di scarico: 5 metri in verticale (tubo Ø 32 mm.)
 50 metri in orizzontale (tubo Ø 32 mm.)

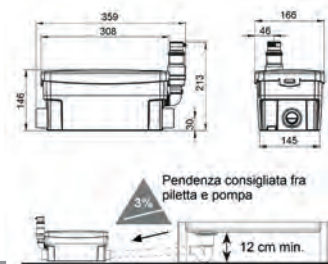

codice	sigla	Nr. entrate	Livello sonoro	UM	min. ord. conf.	cat.	prezzo (€)
● 3350040	SH+	2	40 dB(A)	NR	1	17	885,22

SANIVITE PLUS+

Pompa domestica per acque chiare, specifica per cucine e lavanderie. Temperatura max delle acque reflue: 60°C ad intermittenza (max 5 min.) A corredo: valvola clapet, filtro a carboni attivi, per neutralizzare gli odori.

Applicazioni: lavatrice - lavabo - lavastoviglie - bidet - lavello - doccia - vasca da bagno - addolcitore acqua
Capacità di scarico: 5 metri in verticale (tubo Ø 32 mm.)
 50 metri in orizzontale (tubo Ø 32 mm.)

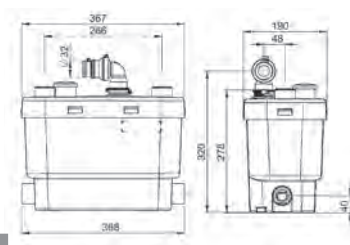

codice	sigla	Nr. entrate	Livello sonoro	UM	min. ord. conf.	cat.	prezzo (€)
● 3350110	SVES+	4	46 dB(A)	NR	1	17	1.082,10

SANISPEED PLUS+

Pompa per acque chiare ideale per ambienti commerciali come piccoli negozi, uffici, bar, lavanderie e studi dentistici. Temperatura max delle acque reflue: 75°C ad intermittenza (max 5 min.) A corredo: valvola clapet, filtro a carboni attivi per neutralizzare gli odori.

Applicazioni: lavabo - bidet - doccia - vasca da bagno - lavello - lavatrice - lavastoviglie
Capacità di scarico: 7 metri in verticale (tubo Ø 32 mm.)
 70 metri in orizzontale (tubo Ø 32 mm.)

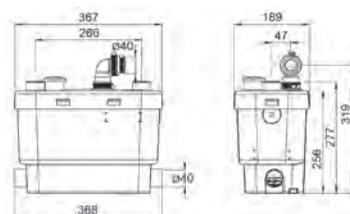

codice	sigla	Nr. entrate	Livello sonoro	UM	min. ord. conf.	cat.	prezzo (€)
● 3350640	SDS+	4	42 dB(A)	NR	1	17	1.254,89

SANICUBIC 1

Stazione di sollevamento per acque chiare e scure con una testata trituratrice, progettata per uso singolo (villetta, piccolo locale commerciale). Potenza motore 1.500 W. Temperatura max delle acque reflue: 70°C ad intermittenza (max 5 min.) A corredo: valvola clapet integrata, allarme remoto via cavo.

Applicazioni: lavabo - bidet - wc - vasca da bagno - doccia - lavatrice - lavello - lavastoviglie - degrassatore
Capacità di scarico: 11 metri in verticale (tubo Ø 50 mm.)
 110 metri in orizzontale (tubo Ø 50 mm.)

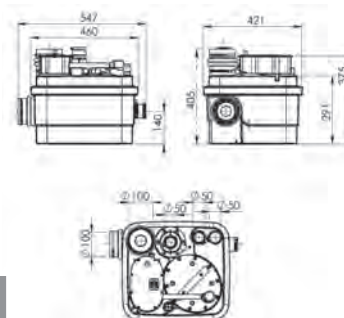

codice	sigla	Indice di protezione	Serbatoio	UM	min. ord. conf.	cat.	prezzo (€)
● 3350070	SQ1	IP 67	32 lt	NR	1	17	2.489,52

COMPLEMENTI SANITARI

CATALOGO
LISTINO N° 8

PRODOTTI TECNICI

MINUTERIA IDRAULICA E ACCESSORI	216
PRODOTTI TECNICI E CHIMICI	222
CONTATORI ACQUA	229
RUBINETTERIA DA ESTERNO	231
RUBINETTI GALLEGGIANTI	233

MINUTERIA IDRAULICA E ACCESSORI

TUBI CROMATI IN RAME

ROTOLO TUBO RAME



codice	sigla	∅	lungh. (cm)	UM	min. ord.	conf.	cat.	prezzo (€)
● 2750101	06600500CR	10	500	NR	1	10	09	60,48
● 2750102	06602500CR	12	500	NR	1	10	09	75,60

TUBETTO PROLUNGA



codice	∅	lungh. (cm)	UM	min. ord. conf.	cat.	prezzo (€)
● 2750501	10	30	NR	10	09	9,80

TUBETTO PER MISCELATORE



codice	∅	lungh. (cm)	UM	min. ord. conf.	cat.	prezzo (€)
● 2750502	10	30	NR	1	09	7,16

TUBETTO LISCIO



codice	∅	lungh. (cm)	UM	min. ord. conf.	cat.	prezzo (€)
● 2750510	10	100	NR	1	09	17,00

TUBETTO CON GHIERA



codice	sigla	∅	lungh. (cm)	UM	min. ord. conf.	cat.	prezzo (€)
● 2750541	02700030CR	3/8"x10	30	NR	25	09	7,68
● 2750540	02700100CR	3/8"x10	100	NR	10	09	18,52
● 2750531	02500030CR	1/2"x10	30	NR	25	09	7,68
● 2750532	02500050CR	1/2"x10	50	NR	25	09	10,60
● 2750533	02500100CR	1/2"x10	100	NR	10	09	18,52

BICONO MASCHIO



codice	sigla	Ø	filetto (mm)	UM	min. ord. conf.	cat.	prezzo (€)
● 2750240	0321B330CR	3/8"x10	13	NR	10	06	3,35
● 2750241	0320B330CR	3/8" x10	20	NR	10	06	4,00
● 2750242	0320B342CR	3/8" x12	20	NR	10	06	4,64
● 2750244	0321B430CR	1/2" x10	13	NR	10	06	3,35
● 2750245	0320B430CR	1/2" x10	20	NR	10	06	4,00
● 2750246	0320B442CR	1/2" x12	20	NR	10	06	4,64
● 2750247	0320B444CR	1/2" x14	20	NR	10	06	4,64

BICONO FEMMINA



codice	sigla	attacco Ø	calotta Ø	UM	min. ord. conf.	cat.	prezzo (€)
● 2750311	0041B330CR	3/8"	3/8"x10	NR	10	06	3,56
● 2750313	0041B430CR	1/2"	3/8"x10	NR	10	06	4,46
● 2750314	0041B440CR	1/2"	1/2"x10	NR	10	06	4,46
● 2750315	0041B442CR	1/2"	1/2"x12	NR	10	06	4,86
● 2750316	0041B444CR	1/2"	1/2"x14	NR	10	06	4,46

BICONO DOPPIO



codice	sigla	calotta Ø	UM	min. ord. conf.	cat.	prezzo (€)
● 2750301	0040B310CR	3/8"x10	NR	10	06	4,86

BICONO DOPPIO A GOMITO



codice	sigla	calotta Ø	UM	min. ord. conf.	cat.	prezzo (€)
● 2750321	0042B310CR	3/8"x10	NR	10	06	7,31

BICONO MASCHIO PROLUNGATO CON ROSONE



codice	sigla	attacco Ø	calotta Ø	UM	min. ord. conf.	cat.	prezzo (€)
● 2750251	0330C330CR	3/8"	3/8"x10	NR	2	06	4,86
● 2750252	0330C430CR	1/2"	3/8"x10	NR	2	06	4,86

NIPPLE RIDOTTO PROLUNGATO CON ROSONE



codice	sigla	Ø	UM	min. ord. conf.	cat.	prezzo (€)
● 2750263	0330R430CR	1/2"x3/8"	NR	2	06	4,21

PROLUNGA PER RETROGRUPPO CALOTTA GIREVOLE

Lunghezza 40 mm



codice	sigla	attacco Ø	foro Ø	UM	min. ord. conf.	cat.	prezzo (€)
● 2751122	00630530CR	3/4"M x 3/4"F	3/8"	NR	1	06	10,94
● 2751123	0063F540CR	3/4"M x 3/4"F	1/2"	NR	1	06	13,50
● 2751121	00620500CR	3/4"M x 3/4"F	-	NR	1	06	11,16

NIPPLE RIDOTTO PROLUNGATO SENZA ROSONE



codice	sigla	Ø	UM	min. ord. conf.	cat.	prezzo (€)
● 2750264	03300430CR	1/2"x3/8"	NR	2	06	4,00
● 2750266	03300442CR	1/2"x1/2"	NR	2	06	4,00

PROLUNGA CON E SENZA CALOTTA

Lunghezza 40 mm



codice	sigla	attacco Ø	calotta Ø	UM	min. ord. conf.	cat.	prezzo (€)
● 2735041	0050B340CR	3/8"	3/8"x10	NR	10	06	4,46
● 2735031	00500340CR	3/8"	-	NR	10	06	3,13

MINUTERIA IDRAULICA E ACCESSORI

ROSONI

ROSONE PER CURVE 45°



codice	sigla	rosone (mm)	altezza (mm)	UM	min. ord. conf.	cat.	prezzo (€)
● 2661006	-115.321.0.	77	18	NR	25	20	2,95

ROSONE PER CANOTTO



codice	Ø tubo	rosone (mm)	altezza (mm)	UM	min. ord. conf.	cat.	prezzo (€)
● 2750601	26	76	32	NR	50	20	2,73
● 2750602	30	76	32	NR	50	20	2,73
● 2750603	32	76	32	NR	50	20	2,73

ROSONE GIGANTE



codice	Ø tubo	rosone (mm)	altezza (mm)	UM	min. ord. conf.	cat.	prezzo (€)
● 2750623	32	105	42	NR	10	20	11,44

ROSONE



codice	Ø	rosone (mm)	UM	min. ord. conf.	cat.	prezzo (€)
● 2750620	1/2"	59	NR	100	20	1,58
● 2750641	1/2"	72	NR	50	20	2,38
● 2750640	3/4"	72	NR	50	20	2,38

ROSONE A SCATOLA



codice	sigla	Ø	rosone (mm)	altezza (mm)	UM	min. ord. conf.	cat.	prezzo (€)
● 2750624	06550410CR	1/2"	60	10	NR	50	20	2,64
● 2750625	06550420CR	1/2"	60	20	NR	15	20	3,17

CAPPUCCIO UNIVERSALE PER RUBINETTO INCASSO



codice	sigla	Ø	rosone (mm)	altezza (mm)	UM	min. ord. conf.	cat.	prezzo (€)
● 2750903	05820000CR	1/2"	60	55	NR	1	20	15,22

MINUTERIA IDRAULICA E ACCESSORI

TAPPI COPRIFORO

COPRIFORO mm.54,5 D.1/2" CROMATO



codice	sigla	Ø	rosone (mm)	UM	min. ord.	conf.	cat.	prezzo (€)
● 2750901	06700400CR	M 1/2"	54,5	NR	1	50	20	3,96

COPRIFORO CROMATO



codice	sigla	Ø	UM	min. ord.	conf.	cat.	prezzo (€)
● 2750902	06750000CR	54	NR	1	50	20	7,88

COPRIFORO BIANCO



codice	Ø	UM	min. ord. conf.	cat.	prezzo (€)
● 2750904	50	NR	20	20	6,25

COPRIFORO BIANCO RAL 9010



codice	sigla	Ø	UM	min. ord.	conf.	cat.	prezzo (€)
● 2750908	06750000VR	54	NR	1	50	20	25,43

TAPPO PROVA IMPIANTI 1/2" CON GUARNIZIONE



codice	colore	UM	min. ord.	conf.	cat.	prezzo (€)
● 2651046	ROSSO	NR	10	200	14	1,20
● 2651047	BLU	NR	10	200	14	1,20

BORCHIA CROMATA PER TROPPO PIENO



codice	Ø	UM	min. ord. conf.	cat.	prezzo (€)
● 2750905	18	NR	10	24	1,44
● 2750906	24	NR	10	24	1,44
● 2750907	28	NR	10	24	1,52

MORSETTI

MORSETTO PER CONDIZIONAMENTO



codice	Ø	Ø cannette	UM	min. ord. conf.	cat.	prezzo (€)
● 2006607	34	14	NR	50	14	4,60

MORSETTO PER TUBO SCARICO REDI



codice	Ø	Ø canotto	UM	min. ord. conf.	cat.	prezzo (€)
● 2006608	32	26	NR	50	14	0,95

MINUTERIA IDRAULICA E ACCESSORI

MORSETTI

MORSETTO PER CURVA TECNICA



codice	∅	∅ canotto (mm)	UM	min. ord. conf.	cat.	prezzo (€)
● 2006602	40	26-32	NR	50	23	1,08

MORSETTO PER CURVA TECNICA

Per Geberit e Wavin



codice	∅	∅ canotto (mm)	UM	min. ord. conf.	cat.	prezzo (€)
● 2006605	47	26-32	NR	50	23	1,20

MORSETTO PER CURVA TECNICA

Per Geberit



codice	∅	∅ canotto (mm)	UM	min. ord. conf.	cat.	prezzo (€)
● 2006606	46	40	NR	50	23	0,90

MORSETTO PER CURVA TECNICA



codice	∅	∅ canotto (mm)	UM	min. ord. conf.	cat.	prezzo (€)
● 2006603	50	26-32	NR	50	23	2,10
● 2006604	50	40	NR	50	23	1,92

MORSETTO BIANCO PER WC



Confezione 10 pz.

codice	∅	∅ canotto (mm)	UM	min. ord. conf.	cat.	prezzo (€)
● 2006601	50	26-32	1 NR	50	23	1,86
● 3302114	50	40	2 CF	1	23	18,50

MORSETTO BIANCO PER WC



Confezione 10 pz.

codice	∅	∅ canotto (mm)	UM	min. ord. conf.	cat.	prezzo (€)
● 2006621	60	30	1 NR	50	23	1,38
● 3302115	60	40	2 CF	1	23	18,50

MANICOTTI WC

MANICOTTO SCARICO WC DIRITTO BIANCO



codice	∅	UM	min. ord. conf.	cat.	prezzo (€)
● 2651034	110	NR	1 36	24	9,60

MANICOTTO SCARICO WC ECCENTRICO BIANCO



codice	∅	UM	min. ord. conf.	cat.	prezzo (€)
● 2651035	110	NR	1 36	24	9,60

MANICOTTO WC DRITTO IN GOMMA NERA



codice	∅	UM	min. ord. conf.	cat.	prezzo (€)
● 2005015	100-110	NR	1	23	13,20

MANICOTTO WC ECCENTRICO IN GOMMA NERA



codice	∅	UM	min. ord. conf.	cat.	prezzo (€)
● 2005016	110	NR	1	23	21,90

MINUTERIA IDRAULICA E ACCESSORI

CURVE TECNICHE WC

CURVA TECNICA WC C/GUARNIZIONE EPDM



codice	∅	UM	min. ord.	conf.	cat.	prezzo (€)
● 2651052	90	NR	1	30	24	16,40
● 2651051	100	NR	1	24	24	16,40
● 2651050	110	NR	1	24	24	16,40

TUBO PROLUNGA WC



codice	∅	lunghezza (cm)	UM	min. ord.	conf.	cat.	prezzo (€)
● 2651059	90	35	NR	1	16	24	16,40
● 2651062	100	25	NR	1	16	24	16,40
● 2651061	110	25	NR	1	16	24	16,40
● 2651060	110	35	NR	1	16	24	16,40

CURVA WC PER RISTRUTTURAZIONE



codice	∅	UM	min. ord.	conf.	cat.	prezzo (€)
● 2651053	90-100-110	NR	1	12	24	40,96

CURVA TECNICA DA TAGLIARE



codice	∅	UM	min. ord.	conf.	cat.	prezzo (€)
● 2651054	100	NR	1	12	24	42,80

TUBO ESTENSIBILE PER WC



codice	∅	lunghezza (cm)	UM	min. ord.	conf.	cat.	prezzo (€)
● 2005013	90-100-110	23-57	NR	1	12	24	39,92

ROSONE DI RIFINITURA



codice	∅	UM	min. ord.	conf.	cat.	prezzo (€)
● 2651070	90	NR	1	10	24	4,32
● 2651072	110	NR	1	10	24	4,32

KIT FISSAGGIO PER CURVA TECNICA



codice	UM	min. ord.	conf.	cat.	prezzo (€)
● 2651058	NR	1	10	24	10,24

GUARNIZIONE CON ALETTA PER CURVA TECNICA



codice	∅	UM	min. ord.	conf.	cat.	prezzo (€)
● 2651057	90-100-110	NR	1	10	24	5,60

PRODOTTI TECNICI E CHIMICI

TRATTAMENTO E MANUTENZIONE IMPIANTI

F1 PROTECTOR ml.500

Protettivo. Soluzione neutra che protegge dalla corrosione interna e dai depositi di calcare tutti i tipi di impianti termici.

Compatibile con tutti i tipi di metalli (compreso alluminio), plastiche e materiali comunemente utilizzati.

Dosaggio: 500 ml ogni 100 lt d'acqua. Prima di aggiungere F1 Protector, pulire l'impianto con F3 Cleaner.



codice	sigla	UM	min. ord. conf.	cat.	prezzo (€)
● 2009003	53663	NR	10	05	53,73

F3 CLEANER ml.500

Rigeneratore. Soluzione neutra per rimuovere fanghi, alghe e depositi da impianti vecchi, o residui di fabbricazione ed installazione da impianti nuovi.

Compatibile con tutti i tipi di metalli (compreso alluminio), plastiche e materiali comunemente utilizzati.

Dosaggio: 500 ml ogni 100 lt d'acqua. Dopo aver pulito l'impianto si raccomanda di aggiungere F1 Protector.



codice	sigla	UM	min. ord. conf.	cat.	prezzo (€)
● 2009004	53637	NR	10	05	52,32

F4 LEAK SEALER ml.500

Sigillaperdite. Soluzione neutra per sigillare micro-fessure responsabili di piccole perdite ed inaccessibili, in tutti i tipi di impianti termici.

Compatibile con tutti i tipi di metalli (compreso alluminio), e materiali comunemente utilizzati.

Dosaggio: 500 ml ogni 100 lt d'acqua, efficace nell'arco di 1-24 ore, in acqua tiepida/calda circolante. Non viene garantita la sigillatura di qualsiasi tipo di perdita. Una volta sigillata la perdita si raccomanda di aggiungere F1 Protector.



codice	sigla	UM	min. ord. conf.	cat.	prezzo (€)
● 2009005	52818	NR	1	10	56,70

F8 POWERFLUSHING CLEANER ml.500

Detergente. Soluzione neutra ad alte prestazioni per impianti termici molto contaminati, rimuove residui di lavorazione, fanghi ed incrostazioni da nuovi e vecchi impianti di qualsiasi età con problemi ostinati, ripristinando l'efficienza di riscaldamento, riducendo il rumore della caldaia.

Dosaggio: 500 ml ogni 130 lt d'acqua. Ø 16 radiatori.

Dopo aver pulito l'impianto si raccomanda di aggiungere F1 Protector.



codice	sigla	UM	min. ord. conf.	cat.	prezzo (€)
● 2009017	62487	NR	1	10	82,75

F7 BIOCIDE ml. 200

Antialghe. Additivo concentrato per impianti riscaldamento a pavimento e refrigerazione, per evitare la proliferazione batterica e la formazione di alghe.

Dosaggio: 200 ml ogni 150 lt d'acqua, da utilizzare in abbinamento all'F1 Protector



codice	sigla	UM	min. ord. conf.	cat.	prezzo (€)
● 2009000	62393	NR	1	10	42,02

SOLAR S1 lt.10

Fluido termovettore. Protezione anticorrosiva e antigelo (fino a -28°C) per impianti solari che raggiungono temperature molto elevate (ristagno superiore a 360°C).

PRONTO ALL'USO (quindi non diluire)



codice	sigla	UM	min. ord. conf.	cat.	prezzo (€)
● 2009008	57675	NR	1	05	166,21

F9 PROTECTOR + FILTERFLUID ml. 500

Abbinato ad un defangatore magnetico, protegge l'impianto dalla corrosione e dalle incrostazioni. Miscela di disperdenti che porta in sospensione le impurità convogliandole nel filtro.

E' possibile quindi lasciarlo all'interno dell'impianto senza effettuare il risciacquo.

Dosaggio: 500 ml ogni 100 lt d'acqua



codice	sigla	UM	min. ord. conf.	cat.	prezzo (€)
● 2009009	62235	NR	1	10	57,79

DISINCROSTANTE ACIDO INIBITO lt.5

Liquido a viraggio di colorazione inibito specifico per la rimozione di incrostazioni calcaree e ossidi da scambiatori di calore e superfici metalliche. Compatibile con ACCIAIO, RAME e GHISA (non adatto su alluminio, inox e acciaio zincato). Diluizione consigliata: 10%-20%



codice	UM	min. ord. conf.	cat.	prezzo (€)
● 2006020	NR	1	4	26,46

SILICONE ANTIMUFFA



codice	descrizione	contenuto (ml)	UM	min. ord.	conf.	cat.	prezzo (€)
● 2005030	Acetico Trasparente	280	NR	24	24	21	8,36
● 2005031	Acetico Bianco	280	NR	24	24	21	10,07
● 2005040	Neutro Trasparente	310	NR	24	24	21	11,51
● 2005041	Neutro Bianco	310	NR	1	24	21	13,22
● 2005050	Alta Temperatura rosso	280	NR	1	24	21	16,53
● 2005051	Alta Temperatura nero	280	NR	1	24	21	16,95

SIGILLANTE E ADESIVO IBRIDO

Incolla e sigilla piastrelle, pietra, granito, vetro, metacrilato, PVC, cartongesso, intonaco, acciaio, lamiera, alluminio, rame, polistirolo. Anche su superfici umide. Inodore e verniciabile.



codice	colore	contenuto (gr)	UM	min. ord. conf.	cat.	prezzo (€)
● 2005084	cristallino	290	NR	1	21	24,89

PASTA SIGILLANTE PER GIUNTI FILETTATI

In condotte di acqua, gas naturale e gas di città.



codice	contenuto (gr)	UM	min. ord. conf.	cat.	prezzo (€)
● 2006372	450	NR	12	02	17,24

ERMETIC PASTA VERDE

Mastice per raccordi filettati, impianti civili ed industriali.

Limite di temperatura: -20°C + 70°C (gas)
-20°C + 90°C (acqua)



codice	contenuto (gr)	UM	min. ord. conf.	cat.	prezzo (€)
● 2006373	460	NR	30	02	4,08

EXTRA GAS PASTA MARRONE

Mastice di alta qualità per raccordi filettati, ideale per gas metano, NON ADATTO PER GPL.

Limite di temperatura: -30°C + 70°C (gas)
-30°C + 90°C (acqua)



codice	contenuto (gr)	UM	min. ord. conf.	cat.	prezzo (€)
● 2006374	460	NR	30	02	5,47

FILO SIGILLANTE LOCTITE 55

Nastro in multifibra di nylon, in sostituzione di paste, canapa e nastri di tenuta.

Rispetta le seguenti normative:

- ACQUA POTABILE: Cert. Italiana C.S.A.,

standard KTW, approvato WRC.

- GAS E ACQUA: Marchio IMO-UNICIG, UNI EN 751-2, approvato DVGW, DIN 32160



codice	contenuto (mt)	UM	min. ord. conf.	cat.	prezzo (€)
● 2006361	160	NR	15	04	27,44

KIT LOCTITE 55 (5pz.+OMAGGIO)

Kit formato da 5 pezzi di Loctite 55 (2006361) e oggettistica in omaggio (variabile)



codice	UM	min. ord.	conf.	cat.	prezzo (€)
● 2006363	CF	1	10	04	137,14

PRODOTTI TECNICI E CHIMICI

SILICONI E SIGILLANTI

TANGIT PVC-U TUBETTO

Adesivo speciale a presa rapida, a base di solvente, per PVC-U rigido e ABS, non adatto per PE, PP e PTFE.



codice	contenuto (gr)	UM	min. ord. conf.	cat.	prezzo (€)
● 2006380	125	NR	12	05	19,10

TANGIT PVC-U BARATTOLO + PENNELLO

Adesivo speciale a presa rapida, a base di solvente, per PVC-U rigido e ABS, non adatto per PE, PP e PTFE.



codice	contenuto (gr)	UM	min. ord. conf.	cat.	prezzo (€)
● 2006381	250	NR	12	05	32,06

CANAPA PETTINATA

Extra fine



codice	contenuto (gr)	UM	min. ord. conf.	cat.	prezzo (€)
● 2006002	250	NR	1	80	11,74

STRISCE BUTILICHE ELASTOPLASTICHE AUTOADESIVE

Indicato per piani cottura e per giunzioni tra vetro, legno, metallo e vetroresina. Foglio da n.4 strisce preformate 490x15x8 mm. pronte all'uso.



codice	UM	min. ord. conf.	cat.	prezzo (€)
● 2005090	NR	30	08	8,19

SCHIUMA POLIURETANICA LAND

Schiuma poliuretana autoespandente per la sigillatura impermeabile di pozzetti, tubi e canali sia di materiale cementizio che di materiale plastico. Non idonea su PE, silicone e PTFE. Pronto all'uso, di colore blu.



codice	contenuto (gr)	UM	min. ord. conf.	cat.	prezzo (€)
● 2006025	750	NR	1	12	18,18

ADESIVO PER PVC IN TUBETTO

Adesivo saldante trasparente, a base di PVC disciolto in solventi. Per tubi e raccordi in PVC rigido, utilizzabile anche per incollare ABS, PVA e polistirolo rigido.



codice	contenuto (gr)	UM	min. ord. conf.	cat.	prezzo (€)
● 2006385	125	NR	1	30	7,98

COLLA K 414

Adesivo per isolamento in gomma espansa, resistente agli agenti atmosferici e all'invecchiamento.



codice	contenuto (lt)	UM	min. ord. conf.	cat.	prezzo (€)
● 2006350	0,5	NR	1	20	23,28

CANAPA IN BALLETTTE

Extra fine



codice	contenuto (kg)	UM	min. ord. conf.	cat.	prezzo (€)
● 2006004	25	KG	25	06	39,71

DRIP STOP MASTICE EPOSSIDICO BICOMPONENTE

Bicomponente per arrestare le perdite di tubazioni senza svuotare l'impianto. Verniciabile, ideale per riparazioni su metalli, vetro, plastica, legno. Polimerizza a temperatura ambiente ed anche immerso nell'acqua.



codice	contenuto (gr)	UM	min. ord. conf.	cat.	prezzo (€)
● 2006029	65	NR	1	24	10,30

NASTRO P.T.F.E. PROFESSIONALE

Alta qualità (100% PTFE), ideale per grandi diametri (>2")



codice	spess. (mm)	altezza (mm)	lungh. (mt)	colore	UM	min. ord.	conf.	cat.	prezzo (€)
● 2006307	0,20	19	15	giallo	NR	25	250	22	2,56
● 2006308	0,20	25	15	rosso	NR	25	250	22	4,33

NASTRO P.T.F.E. ALTA DENSITA'

Particolarmente indicato per temperature e pressioni elevate (per esempio impianti di vapore, pannelli solari, ecc.)



codice	spess. (mm)	altezza (mm)	lungh. (mt)	colore	UM	min. ord.	conf.	cat.	prezzo (€)
● 2006323	0,10	12	12	bianco	NR	10	250	22	2,94
● 2006322	0,10	12	12	rosa	NR	10	250	22	2,94

NASTRO P.T.F.E. GAS



codice	spess. (mm)	altezza (mm)	lungh. (mt)	UM	min. ord.	conf.	cat.	prezzo (€)
● 2006304	0,10	12	12	NR	250	22		0,80
● 2006305	0,10	19	12	NR	250	22		1,18

NASTRO P.T.F.E. CERTIFICATO DVGW

Conforme alla norma UNI-EN 751-3, Certificato DIN-DVGW e BAM. Indispensabile per sigillature a norma di raccordi filettati in condotte di gas, acqua, ossigeno, ecc.



codice	spess. (mm)	altezza (mm)	lungh. (mt)	UM	min. ord.	conf.	cat.	prezzo (€)
● 2006330	0,10	12	12	NR	250	22		1,47

NASTRO P.T.F.E.

Nastro in resina PTFE per tenuta di raccordi filettati di qualsiasi tipo (metallo, plastica ecc.). Atossico, inodore, insolubile ed infiammabile, adatto per impianti alimentari e chimici.



codice	spess. (mm)	altezza (mm)	lungh. (mt)	UM	min. ord.	conf.	cat.	prezzo (€)
● 2006300	0,076	12	10	NR	250	22		0,50
● 2006301	0,076	12	12	NR	250	22		0,59

NASTRO ADESIVO ANTICONDENSA

In elastomero



codice	spess. (mm)	altezza (mm)	lungh. (mt)	UM	min. ord.	conf.	cat.	prezzo (€)
● 2006341	3	50	10	NR	24	19		6,95
● 2006340	3	50	15	NR	12	19		11,55

PRODOTTI TECNICI E CHIMICI

NASTRI

NASTRO ADESIVO ALLUMINIO LISCIO

In alluminio puro

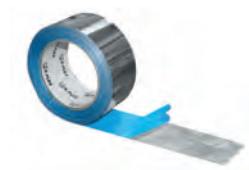

codice	spess. (micron)	altezza (mm)	lungh. (mt)	UM	min. ord. conf.	cat.	prezzo (€)
● 2006410	25	50	50	NR	24	19	15,59

NASTRO ADESIVO ALLUMINIO LISCIO

In alluminio anodizzato



codice	spess. (micron)	altezza (mm)	lungh. (mt)	UM	min. ord. conf.	cat.	prezzo (€)
● 2006413	40	50	50	NR	24	09	18,20

NASTRO ADESIVO ALLUMINIO RETINATO

Retinatura in vetro tessile

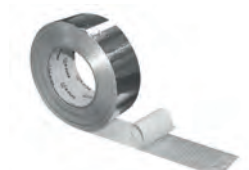

codice	spess. (micron)	altezza (mm)	lungh. (mt)	UM	min. ord. conf.	cat.	prezzo (€)
● 2006415	43	50	50	NR	24	19	19,87

NASTRO ADESIVO DIELETTRICO PVC



codice	altezza (mm)	lungh. (mt)	colore	UM	min. ord. conf.	cat.	prezzo (€)
● 2006313	38	25	nero	NR	24	19	6,99
● 2006311	50	25	nero	NR	18	19	7,82
● 2006312	50	25	grigio	NR	18	19	7,82

BENDA VINILICA

In PVC, non adesiva.



codice	altezza (cm)	lungh. (mt)	colore	UM	min. ord. conf.	cat.	prezzo (€)
● 2006346	10	25	bianca	NR	70	19	8,19

NASTRO SEGNALETICO ACQUA/GAS

Nastro di polietilene (80µm) per la segnalazione di tubi acqua e gas interrati. Striscia di avvertimento da posare a 30/50 cm sopra il tubo.



codice	tipo	altezza (mm)	lungh. (mt)	UM	min. ord. conf.	cat.	prezzo (€)
● 2006030	ACQUA	12,5	200	NR	1	10 02	29,82
● 2006031	GAS	12,5	200	NR	1	10 02	29,82

CLIMAFOAM SPRAY

Detergente schiumogeno per condizionatori per la pulizia dei pacchi alettati e dei filtri delle unità interne degli impianti di aria condizionata. Disgrega lo sporco ed emulsionandolo permette di eliminarlo facilmente.



codice	contenuto (ml)	UM	min. ord. conf.	cat.	prezzo (€)
● 2006010	500	NR	12	02	19,75

CONDIBAT SPRAY

Sanificante e igienizzante per condizionatori, fan coil e piccoli ambienti in soluzione alcolica >70% in combinazione con sostanze fenoliche. Testato secondo il metodo UNI EN 1040:2005

Proprietà chimico fisiche

Forma: Aerosol
 Colore: Incolore
 Odore: Fiori di campo
 pH: 11,25 ± 0,25
 Solubilità/Miscibilità acqua: Poco solubile
 VOC (%): 50,40



codice	contenuto (ml)	UM	min. ord. conf.	cat.	prezzo (€)
● 2006011	500	NR	12	02	25,94

TANGIT KS DETERGENTE

Detergente specifico per giunzioni in plastica da termosaldare. Adatto per PE, PP e PVDF.



codice	contenuto (lt)	UM	min. ord. conf.	cat.	prezzo (€)
● 2006382	1	NR	8	05	36,45

ETERPLAST SPRAY PER GIUNTI ELETTROSALDABILI

Detergente spray a base di solventi, specifico per la pulizia di giunti da elettrosaldare. Adatto per PE e PP.



codice	contenuto (ml)	UM	min. ord. conf.	cat.	prezzo (€)
● 2006034	400	NR	12	02	8,98

SCIVOLINA SPRAY BOMBOLA

Lubrificante protettivo spray, a base di olio di silicone, confezionato con propellente esente da CFC. Ideale per l'innesto di tubazioni in pp e PVC con anello; oltre a facilitare lo scorrimento mantiene morbida la guarnizione nel tempo.



codice	contenuto (ml)	UM	min. ord. conf.	cat.	prezzo (€)
● 2006384	400	NR	1	12	10,94

SCIVOLINA TUBETTO

Gel lubrificante, inodore, a base di olii silconici. Facilita l'innesto di tubi con o-ring, protegge la guarnizione. Non contiene alcun tipo di sapone.



codice	contenuto (ml)	UM	min. ord. conf.	cat.	prezzo (€)
● 2006383	250	NR	1	50	4,90

CS CLEANER DISINCROSTANTE CASSETTE

Liquido a viraggio di colorazione inibito specifico per la rimozione rapida di incrostazioni calcaree ed ossidi nelle cassette di risciacquo wc. Evita il rigagnolo giallo nei wc e ripristina un buon funzionamento del galleggiante.

Indicatore di viraggio:
 ROSSO (attivo), GIALLO/ARANCIO (esausto).



codice	contenuto (lt)	UM	min. ord. conf.	cat.	prezzo (€)
● 2006012	1	NR	6	06	9,97

SOLVACAL DISINCROSTANTE IN POLVERE

Prodotto in polvere per la rimozione del calcare da sanitari, docce, rubinetterie, superfici in acciaio inox. Diluito in acqua può essere utilizzato per la pulizia di scambiatori e tubazioni.



codice	contenuto (gr)	UM	min. ord. conf.	cat.	prezzo (€)
● 2006013	500	NR	1	36	14,29

PRODOTTI TECNICI E CHIMICI

PRODOTTI CHIMICI

SGORGOSI' DISOTTURANTE

Disotturante liquido ad alta concentrazione per scarichi, **solo ad uso professionale**, altamente corrosivo.



	codice	contenuto (lt)	UM	min. ord. conf.	cat.	prezzo (€)
●	2006390	1	NR	6	06	9,11

SGORGOSI' GEL DISOTTURANTE

Disotturante gel per scarichi occlusi da materiale organico. Gradevolmente profumato (fresco balsamico).



	codice	contenuto (lt)	UM	min. ord. conf.	cat.	prezzo (€)
●	2006391	1	NR	6	06	10,30

EFFE 91 RILEVATORE FUGHE GAS

Rilevatore di piccole e grandi fughe di gas metano e GPL. Non è infiammabile, non macchia, non favorisce ossidazioni.



	codice	contenuto (ml)	UM	min. ord. conf.	cat.	prezzo (€)
●	2006032	400	NR	12	02	6,46

WD-40 LUBRIFICANTE MULTIFUNZIONE

Lubrificante, sloccante, elimina cigolii, elimina l'umidità, previene la ruggine e protegge tutte le superfici metalliche non porose. Doppia erogazione (vaporizzazione ampia e applicazione dei precisione).



	codice	contenuto (ml)	UM	min. ord. conf.	cat.	prezzo (€)
●	2006024	500	NR	6	05	19,29

PRODOTTI TECNICI

TRACK VERNICE TRACCIANTE SPRAY NERO

Utilizzabile su qualsiasi superficie (muratura, pavimentazione, asfalto, legno, ecc.). Ottima resistenza agli agenti atmosferici.



	codice	contenuto (ml)	UM	min. ord. conf.	cat.	prezzo (€)
●	2006033	400	NR	12	02	9,72

TRACK VERNICE TRACCIANTE SPRAY ROSSO

Utilizzabile su qualsiasi superficie (muratura, pavimentazione, asfalto, legno, ecc.). Ottima resistenza agli agenti atmosferici.



	codice	contenuto (ml)	UM	min. ord. conf.	cat.	prezzo (€)
●	2006035	400	NR	12	02	9,72

CONTATORE ACQUA FREDDA



Installazione sia orizzontale che verticale. Quadrante asciutto a trasmissione magnetica Super Dry 8 rulli.
A norma Europea EN 14154, direttiva MID 2014/32/UE
certificazione di utilizzo con acque potabili DM 6/4/2004 n.174.

Predisposti per emettitore impulsi P= 10 lt.

Confezione completa di raccordi.

Su richiesta, è possibile avere:

- versione con predisposizione radio 868 MHz (EN 13757) OMS.

Campo di misura H-R 100 per installazione orizzontale

V-R 63 per installazione verticale

Pressione d'esercizio (PN) 16 bar

Temperatura massima 50°C

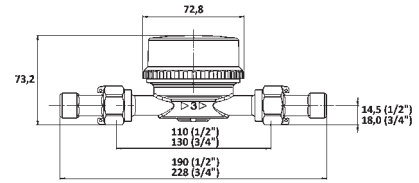

codice	∅	Portata Q3 (m³/ora)	UM	min. ord.	conf.	cat.	prezzo (€)
● 1207101	1/2"	2,5	NR	1	10	05	47,74
● 1207102	3/4"	4,0	NR	1	10	05	58,21
codice	descrizione	UM	min. ord.	conf.	cat.	prezzo (€)	
● 1207959	Emettitore di impulsi Reed Switch	NR	1	1	05	19,84	

CONTATORE ACQUA FREDDA CON COPERCHIO



Installazione sia orizzontale che verticale. Quadrante a rulli protetti, con l'area di lettura non a contatto con l'acqua.

A norma Europea EN 14154, direttiva MID 2014/32/UE
certificazione di utilizzo con acque potabili DM 6/4/2004 n.174.

Non predisposti per emettitore impulsi

Confezione completa di raccordi.

Su richiesta, è possibile avere:

- versione con emettitore impulsi P = 1-10 lt.

Campo di misura H-R 100 per installazione orizzontale

V-R 80 per installazione verticale

Pressione d'esercizio (PN) 16 bar

Temperatura massima 50°C

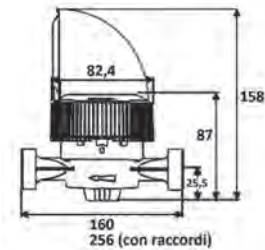

codice	∅	Portata Q3 (m³/ora)	UM	min. ord.	conf.	cat.	prezzo (€)
● 1207121	1"	6,3	NR	1	10	05	145,92

CONTATORE ACQUA CALDA



Installazione sia orizzontale che verticale. Quadrante asciutto a trasmissione magnetica Super Dry 8 rulli.

A norma Europea EN 14154, direttiva MID 2014/32/UE
certificazione di utilizzo con acque potabili DM 6/4/2004 n.174.

Predisposti per emettitore impulsi P= 10 lt.

Confezione completa di raccordi.

Su richiesta, è possibile avere:

- versione con predisposizione radio 868 MHz (EN 13757) OMS.

Campo di misura H-R 100 per installazione orizzontale

V-R 63 per installazione verticale

Pressione d'esercizio (PN) 16 bar

Temperatura massima 90°C

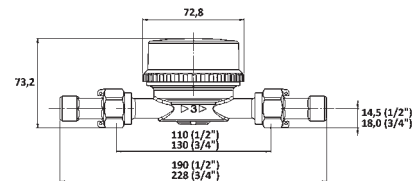

codice	∅	Portata Q3 (m³/ora)	UM	min. ord.	conf.	cat.	prezzo (€)
● 1207111	1/2"	2,5	NR	1	10	05	61,31
● 1207112	3/4"	4,0	NR	1	10	05	76,67
codice	descrizione	UM	min. ord.	conf.	cat.	prezzo (€)	
● 1207959	Emettitore di impulsi Reed Switch	NR	1	1	05	19,84	

RACCORDO PER CONTATORE



codice	∅	UM	min. ord.	conf.	cat.	prezzo (€)
● 1560001	3/4" x 1/2"	NR	10	06		4,61
● 1560002	1" x 3/4"	NR	2	06		9,50

CONTATORI ACQUA

CONTATORI A GETTO MULTIPLIO

CONTATORE PER ACQUA FREDDA



Installazione solo orizzontale. Quadrante a rulli protetti, con l'area di lettura non a contatto con l'acqua. **Confezione completa di raccordi.**
Non predisposto per emettitore impulsivi. A norma Europea EN 14154, direttiva MID 2014/32/UE, certificazione di utilizzo con acque potabili DM 6/4/2004 n.174.

Su richiesta è possibile avere

- emettitore impulsivi P = 1-10-100 lt.
- versione predisposto per radio 868 MHz (EN 13757) OMS.

Campo di misura H-R 100 per installazione orizzontale
Pressione d'esercizio (PN) 16 bar
Temperatura massima 50°C

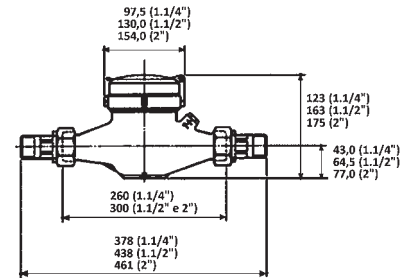

codice	Ø	Portata Q3 (m³/ora)	UM	min. ord.	conf.	cat.	prezzo (€)
● 1207134	1"1/4	10,0	NR	1	5	05	254,27
● 1207135	1"1/2	16,0	NR	1	5	05	445,06
● 1207136	2"	25,0	NR	1	1	05	556,29

CONTATORI A MULINELLO

WOLTMANN PER ACQUA FREDDA PN16



Installazione orizzontale o verticale o inclinata. Estraibile. Trasmissione del movimento tramite giunto magnetico.

Predisposto per 2 uscite impulsivi (una Reed Switch e una di tipo induttivo), per l'installazione dell'emettitore di impulsi senza alterare la sigillatura.

Predisposizione lancia impulsi con sensore Reed Switch (1207159):

- 1 impulso ogni 100 litri da DN 50 a DN100
- 1 impulso ogni 1.000 litri da DN 125 a DN200.

A norma Europea EN 14154, direttiva MID 2014/32/UE, certificazione di utilizzo con acque potabili DM 6/4/2004 n.174.

Campo di misura H-R 100 per installazione orizzontale
Pressione d'esercizio (PN) 10/16 bar
Temperatura massima 50°C

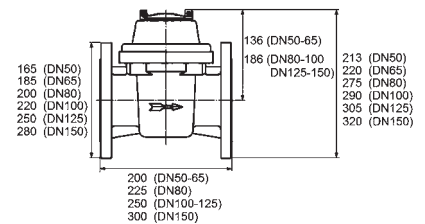

codice	Ø	Portata Q3 (m³/ora)	UM	min. ord.	conf.	cat.	prezzo (€)
● 1207151	50	25,0	NR	1	11		527,54
● 1207152	65	40,0	NR	1	11		611,87
● 1207153	80	63,0	NR	1	11		713,46
● 1207154	100	100,0	NR	1	11		897,67
● 1207155	125	160,0	NR	1	11		1.074,28

codice	descrizione	UM	min. ord.	conf.	cat.	prezzo (€)
● 1207159	Emettitore di impulsi Reed Switch	NR	1	11		104,14



RUBINETTERIA DA ESTERNO

RUBINETTERIA DA ESTERNO

RUBINETTO A SFERA CON PORTAGOMMA

Leva alluminio



codice	∅	UM	min. ord.	conf.	cat.	prezzo (€)
● 2009100	3/8"	NR	20	20	09	14,36
● 2009101	1/2"	NR	25	25	09	14,08
● 2009102	3/4"	NR	15	15	09	19,76
● 2009103	1"	NR	1	10	09	33,20

RUBINETTO A FARFALLA ANTIGHIACCIO CON PORTAGOMMA

Con sistema di regolazione del flusso.
Limite temperatura:
-10°C +100°C



codice	∅	UM	min. ord.	conf.	cat.	prezzo (€)
● 2009120	1/2"	NR	25	25	04	26,66
● 2009121	3/4"	NR	15	15	04	33,20
● 2009122	1"	NR	1	10	04	68,51

GIRELLO CON PORTAGOMMA E GUARNIZIONE

Ricambio per rubinetto 2009100-2009101-2009102-2009103-2009120-2009121-2009122



codice	∅	∅ rubinetto	UM	min. ord.	conf.	cat.	prezzo (€)
● 2009170	3/4" x 15	3/8" - 1/2"	NR	1	5	09	3,76
● 2009171	1" x 20	3/4"	NR	1	5	09	5,04
● 2009172	1"1/4 x 25	1"	NR	1	5	09	10,36

RUBINETTO A SFERA PER IDRANTE

Con portagomma



codice	∅	UM	min. ord.	conf.	cat.	prezzo (€)
● 2009165	1/2"	NR	1	30	04	25,76
● 2009166	3/4"	NR	1	20	04	32,27

RUBINETTO BRONZATO CON LEVA

A vitone passo-rapido con guarnizione in gomma. Con raccordo per portagomma



codice	∅	UM	min. ord. conf.	cat.	prezzo (€)
● 2009010	1/2"	NR	1	22	60,48

RUBINETTO BRONZATO CON VOLANTINO

A vitone normale. Con raccordo per portagomma



codice	∅	UM	min. ord. conf.	cat.	prezzo (€)
● 2009011	1/2"	NR	1	22	60,48

RUBINETTO LUCIDO CON LEVA

Con portagomma



codice	∅	UM	min. ord. conf.	cat.	prezzo (€)
● 2009055	1/2"	NR	1	15	33,74

RUBINETTO A PULSANTE

Contro colpo d'ariete



codice	∅	UM	min. ord. conf.	cat.	prezzo (€)
● 2009060	1/2"	NR	1	15	64,12

RUBINETTERIA DA ESTERNO

RUBINETTERIA DA ESTERNO

RUBINETTO LUCIDO CON CHIAVE ESTRAIBILE

Con portagomma



codice	Ø	UM	min. ord. conf.	cat.	prezzo (€)
● 2009041	1/2"	NR	1	15	23,61

RUBINETTO LUCIDO

Con portagomma



codice	Ø	UM	min. ord. conf.	cat.	prezzo (€)
● 2009020	1/2"	NR	1	15	23,61
● 2009021	3/4"	NR	1	15	37,11

RUBINETTO SABBIAIO

Con portagomma



codice	Ø	UM	min. ord. conf.	cat.	prezzo (€)
● 2009081	1/2"	NR	1	15	16,54

RUBINETTO SABBIAIO CROMATO

Con portagomma



codice	Ø	UM	min. ord. conf.	cat.	prezzo (€)
● 2009071	1/2"	NR	1	15	18,20

RUBINETTO SABBIAIO CROMATO PASSORAPIDO

Con portagomma



codice	Ø	UM	min. ord. conf.	cat.	prezzo (€)
● 2009092	1/2"	NR	1	15	21,94

RUBINETTO GALLEGGIANTE STAMPATO SEDE OTTONE

A 5 coppie, asta tonda in ottone D.5 mm.

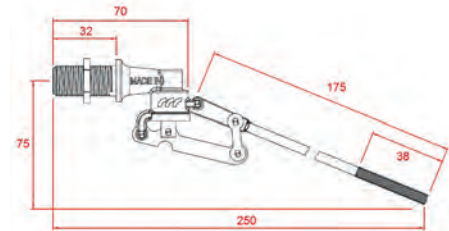

codice	sigla	Ø	sede	Ø sfera consigliata	UM	min. ord.	conf.	cat.	prezzo (€)
● 2012001	510/1.3/8	3/8"	ottone	90	NR	1	100	22	15,92
● 2012002	510/1.1/2	1/2"	ottone	90	NR	1	100	22	16,84

RUBINETTO GALLEGGIANTE STAMPATO / FUSO, SEDE OTTONE / INOX

A 5 coppie, asta piatta AISI 430

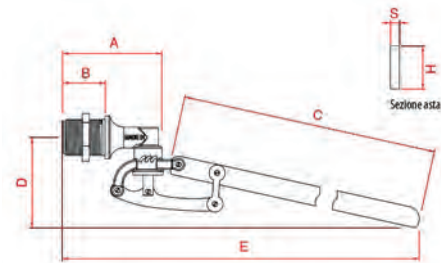

codice	sigla	Ø	corpo	sede	Ø sfera consigliata	UM	min. ord.	conf.	cat.	prezzo (€)
● 2012003	511/5.3/4	3/4"	stampato	ottone	120	NR	1	50	22	25,75
● 2012004	511/5.1	1"	stampato	ottone	150	NR	1	30	22	36,79
● 2012005	511/6.11/4	1"1/4	fuso	ottone	180	NR	1	10	22	76,31
● 2012006	511/6.11/2	1"1/2	fuso	ottone	220	NR	1	10	22	92,48
● 2012007	511/7.2	2"	fuso	ottone	220	NR	1	5	22	134,65
● 2012890	511/10.3/4	3/4"	stampato	inox	120	NR	1	50	22	26,96
● 2012891	511/10.1	1"	stampato	inox	150	NR	1	30	22	38,60

Ø	mm							
	A	B	C	D	E	S	H	
3/4"	78	30	320	110	385	2,9	14	
1"	90	35	320	115	400	2,9	14	
1"1/4	120	43	500	120	600	3,8	18	
1"1/2	140	55	500	135	630	3,8	18	
2"	160	65	580	150	750	3,8	18	

RUBINETTO GALLEGGIANTE STAMPATO SEDE INOX/OTTONE

Asta tonda in ottone D.5 mm, REGOLABILE

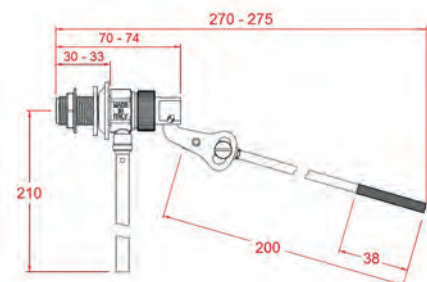

codice	sigla	Ø	Ø sfera consigliata	sede	UM	min. ord.	conf.	cat.	prezzo (€)
● 2012201	516/2.3/8	3/8"	90	inox	NR	1	100	22	16,51
● 2012202	516/2.1/2	1/2"	90	inox	NR	1	100	22	19,11
● 2012203	516/1.1/2	1/2"	90	ottone	NR	1	100	22	18,31

RUBINETTI GALLEGGIANTI

RUBINETTI GALLEGGIANTI

RUBINETTO GALLEGGIANTE STAMPATO SEDE RESINA PDM

TIPO CATIS
Asta tonda in ottone
D.5 mm.

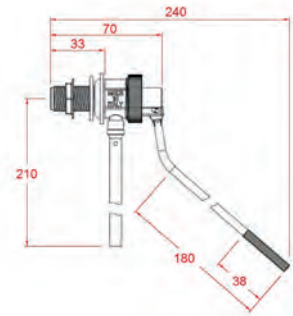

codice	sigla	Ø	Ø sfera consigliata	UM	min. ord.	conf.	cat.	prezzo (€)
2012833	518/3.3/8	3/8"	90	NR	1	100	22	14,32
2012834	518/3.1/2	1/2"	90	NR	1	100	22	17,18

RUBINETTO GALLEGGIANTE STAMPATO SEDE RESINA PDM, CON SFERA

TIPO CATIS. Asta tonda in ottone D.5 mm., completo di sfera in plastica piatta da D. 90

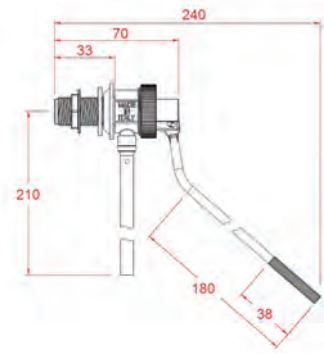

codice	sigla	Ø	UM	min. ord.	conf.	cat.	prezzo (€)
2012847	518/6.3/8+530/2	3/8"	NR	1	22		14,74

PRODOTTI TECNICI

RUBINETTO GALLEGGIANTE STAMPATO SEDE NYLON

Attacco alto, rubinetto d'arresto incorporato, asta sagomata AISI 430 REGOLABILE

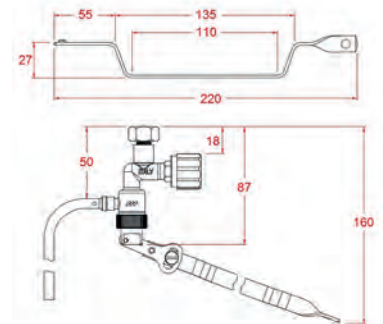

codice	sigla	Ø	Ø sfera consigliata	UM	min. ord.	conf.	cat.	prezzo (€)
2012401	519/1.3/8	3/8"	90	NR	1	50	22	26,54

RUBINETTO GALLEGGIANTE STAMPATO SEDE INOX

Asta piatta AISI 430 REGOLABILE, completo di tubo di carico

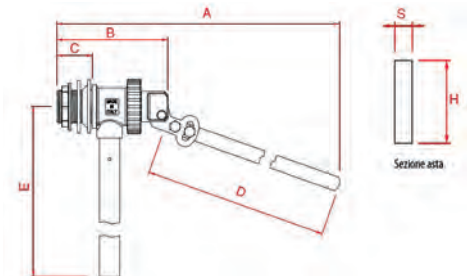

codice	sigla	Ø	Ø sfera consigliata	UM	min. ord.	conf.	cat.	prezzo (€)
2012101	523/1.3/4	3/4"	150	NR	1	30	22	42,84
2012102	523/1.1	1"	180	NR	1	30	22	46,03

Ø	mm						
	A	B	C	D	E	S	H
3/4"	390	92	35	320	320	2,9	14
1"	390	92	35	320	320	2,9	14

RUBINETTI GALLEGGIANTI

RUBINETTI GALLEGGIANTI

RUBINETTO GALLEGGIANTE STAMPATO / FUSO SEDE INOX

Per alte pressioni PN 12
Asta piatta AISI 430
REGOLABILE, completo di
tubo di carico

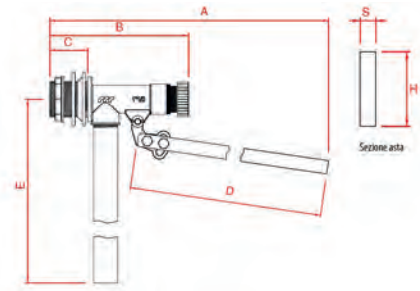

codice	sigla	Ø	corpo	Ø sfera consigliata	UM	min. ord.	conf.	cat.	prezzo (€)
● 2012821	524/1.3/4	3/4"	stampato	150	NR	1	30	22	71,19
● 2012822	524/1.1	1"	stampato	180	NR	1	30	22	73,92
● 2012823	524/2.11/4	1"1/4	fuso	220	NR	1	10	22	144,61
● 2012824	524/2.11/2	1"1/2	fuso	220	NR	1	10	22	151,03
● 2012825	524/2.2	2"	fuso	220	NR	1	5	22	240,49

Ø	mm						
	A	B	C	D	E	S	H
3/4"	580	142-155	37	490	410	3,5	15
1"	580	142-155	37	490	410	3,5	15
1"1/4	690	177-190	40	580	410	3,8	18
1"1/2	700	182-195	50	580	410	3,8	18
2"	720	210-225	55	580	430	3,8	18

SFERA IN PLASTICA CON NOTTOLINO OTTONE



codice	Ø	UM	min. ord. conf.	cat.	prezzo (€)
● 2012501	90	NR	1	20	2,86

SFERA IN PLASTICA CON SCORREVOLE



codice	Ø	UM	min. ord. conf.	cat.	prezzo (€)
● 2012601	120	NR	1	20	4,88
● 2012602	150	NR	1	20	6,07
● 2012603	180	NR	1	20	8,71
● 2012604	220	NR	1	20	23,98

SFERA IN PLASTICA PIATTA CON NOTTOLINO

Tipo Catis



codice	Ø	UM	min. ord. conf.	cat.	prezzo (€)
● 2012701	90	NR	1	20	1,63

SFERA IN RAME CON REGGISFERA SALDATO



codice	Ø	UM	min. ord. conf.	cat.	prezzo (€)
● 2012722	1"- 150	NR	1	20	44,70
● 2012723	1"1/4- 180	NR	1	20	64,37

SFERA IN RAME CON NOTTOLINO



codice	Ø	UM	min. ord. conf.	cat.	prezzo (€)
● 2012711	90	NR	1	20	17,91

CATALOGO
LISTINO N° 8

ACCESSORI CONDIZIONAMENTO

STAFFE PER CONDIZIONATORI	238
SCARICO CONDENSA	239
ACCESSORI CONDIZIONAMENTO	240
RACCORDERIA A PRESSARE IN RAME PER ARIA CONDIZIONATA E REFRIGERAZIONE	242

ACCESSORI CONDIZIONAMENTO

STAFFE PER CONDIZIONATORI

MENSOLA UNIVERSALE PER CONDIZIONATORI

In lamiera zincata spessore 15/10, verniciata con polveri poliesteri (RAL 9002), premontate, ad aggancio regolabile.

Fornite con livella, piedini posteriori regolabili, antivibranti, tasselli di fissaggio.

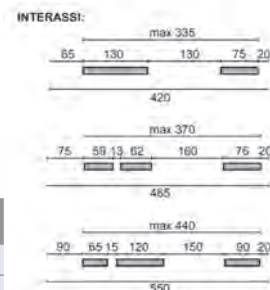
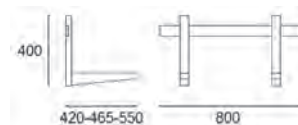

codice	Dimensioni (mm)	Portata (kg)	UM	min. ord.	pz. pallet	cat.	prezzo (€)
● 5850020	P420 x H400 x L800	120	NR	1	150	06	35,82
● 5850021	P465 x H400 x L800	160	NR	1	150	06	38,56
● 5850023	P550 x H400 x L800	160	NR	1	120	06	49,28

STAFFA A TETTO

In lamiera zincata spessore 20/10, verniciata con polveri poliesteri (RAL 9002), regolabile con inclinazione da 15° a 30°.

Fornita con gommini antivibranti e viteria.

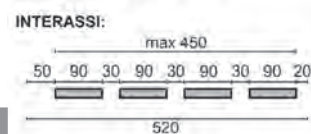

codice	Dimensioni (mm)	Portata (kg)	UM	min. ord. conf.	cat.	prezzo (€)
● 5850040	P520 x L850	15° = 80 30° = 150	NR	1	06	102,78

SCARICO CONDENSA

POMPA SCARICO CONDENSA SANICONDENS CLIM MINI NEW SILENCE

Minipompa interna per split di condizionatori fino a 8 Kw, con sistema di allarme contro le fuoriuscite, perfettamente intercambiabile con modello precedente. A corredo: tubo flessibile da 1,2 mt., supporto di fissaggio, tubo di sfiato, cavi di alimentazione e di allarme.

Applicazioni: split

Capacità di scarico: 6 metri in verticale (tubo Ø 8/10 mm.)
60 metri in orizzontale (tubo Ø 8/10 mm.)

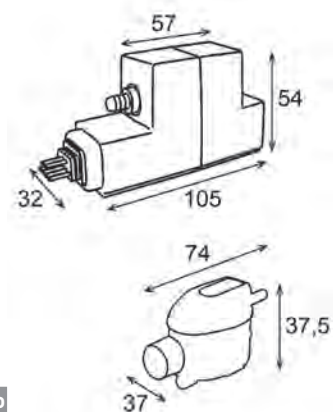

codice	sigla	Portata max	Livello sonoro	UM	min. ord.	conf.	cat.	prezzo (€)
● 3350020	SCONCLIMS	9 lt/h	21dB(A)	NR	1	12	13	123,20

POMPA SCARICO CONDENZA A PISTONE

Adatto per climatizzatori fino a 20Kw. Pompa a pistone, livello sonoro ridotto indipendentemente dal volume di condensa da scaricare.
A corredo: piastrina di fissaggio pompa per montaggio a parete, sulle tubazioni o in sospensione.
Cavo di alimentazione da 0,8 mt, tubo pvc trasparente da 1,5 mt Ø int. 6 mm; kit installazione.



Applicazioni: split
Capacità di scarico verticale: 10 metri (portata 4 lt/h)

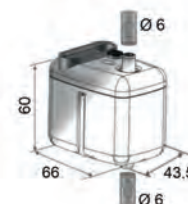

codice	sigla	Portata max	Livello sonoro	UM	min. ord.	conf.	cat.	prezzo (€)
● 3351023	SI27CE01UN23	20 lt/h	20dB(A)	NR	1	20	03	125,55

MINI POMPA SCARICO CONDENZA A PISTONE

Adatta per climatizzatori fino a 20Kw. Pompa a pistone ad alta efficienza, può essere installata all'interno di qualsiasi tipo di condizionatore d'aria o canale grazie al suo spessore ridotto.
A corredo: kit installazione del blocco di rilevamento, cavo di alimentazione da 1,5 mt, tubo pvc trasparente da 6 cm Ø int. 6 mm dotato di un connettore "scarico sicuro" preinstallato, tubo pvc da 63 cm Ø int. 6 mm con schiuma isolante per ridurre la vibrazione, set di fissaggio.



Applicazioni: split
Capacità di scarico verticale: 10 metri (portata 4 lt/h)



codice	sigla	Portata max	Livello sonoro	UM	min. ord.	conf.	cat.	prezzo (€)
● 3351026	SI20CE02UN23	20 lt/h	19 db(A)	NR	1	20	03	219,51

SIFONE SCARICO CONDENZA DA INCASSO CON PLACCA BIANCA

Con pallina di chiusura per i periodi di inutilizzo in cui evapora l'acqua.



codice	sigla	UM	min. ord.	conf.	cat.	prezzo (€)
● 2401101	2370.273.4.	NR	1	15	01	29,17



SIFONE AD INCASSO PER LAVATRICE E ASCIUGATRICE O CONDIZIONAMENTO

Sifone ad incasso con doppia entrata per lavatrice e asciugatrice o scarico condensa condizionatore. In PP, con protezione, attacco lavatrice amovibile e richiudibile, attacco condensa e asciugatrice amovibile e richiudibile con valvola di non ritorno. Uscita D.40, piastra in ABS bianco 130x85.

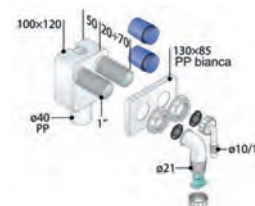

codice	sigla	attacco lavatrice	attacco asciug/conden.	UM	min. ord.	conf.	cat.	prezzo (€)
● 2401202	2207.512.6.	1" x 21	1" x 10/14	NR	1	30	02	35,70

NOVITÀ!

ACCESSORI CONDIZIONAMENTO

SCARICO CONDENSA

SIFONE SCARICO CONDENSA ESTERNO



Con pallina di chiusura per i periodi di inutilizzo in cui evapora l'acqua.

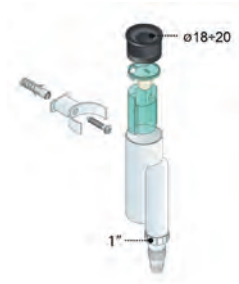

	codice	sigla	UM	min. ord.	conf.	cat.	prezzo (€)
●	2401001	2370.162.4.	NR	1	30	01	10,36

SIFONE SCARICO CONDENSA DA INCASSO CON PLACCA INOX



Con pallina di chiusura per i periodi di inutilizzo in cui evapora l'acqua. Doppio attacco, diritto e curvo.



	codice	sigla	UM	min. ord.	conf.	cat.	prezzo (€)
●	2401004	2370.185.4	NR	1	30	01	17,89

ACCESSORI CONDIZIONAMENTO

BASE A PAVIMENTO



In PVC rigido antiurto, autoestinguente e stabilizzato contro i raggi UV. Compreso fasce adesive antiscivolo e antivibrazione coestruse. Colore avorio. (Il codice è riferito a 1 pezzo)

	codice	descrizione	Portata (kg)	misura (mm)	UM	min. ord. conf.	cat.	prezzo (€)
●	5850052	Base a pavimento	140	L350xH80	NR	24	06	7,24
●	5850050	Base a pavimento	140	L450xH80	NR	24	06	7,99
●	5850051	Tappo x base pavimento	-	L80xH80	NR	4	06	1,73

KIT SUPPORTI A PAVIMENTO REGOLABILI



Kit composto da 4 supporti a cono universali, in materiale termoplastico e fibra di vetro, distanziale in poliuretano fonoassorbente e antivibrante, guarnizione o-ring in NBR antiscivolamento. Fissaggio con dado e bullone. Portata max 325 kg (sui 4 pezzi).

	codice	finitura	regolazione (cm)	UM	min. ord.	conf.	cat.	prezzo (€)
●	5850046	avorio	9 - 14	NR	1	10	06	59,40
●	5850045	nero	9 - 14	NR	1	10	06	59,40

KIT ANTIVIBRANTI

Kit composto da 4 antivibranti, con relativi dadi a rondelle.



	codice	descrizione	misura (mm)	Fig.	UM	min. ord. conf.	cat.	prezzo (€)
●	5850060	Per staffe	39x22	1	NR	20	06	6,37
●	5850061	A pavimento	40x40	2	NR	20	06	14,58

TELO PROTETTIVO PER UNITA' ESTERNE

Cover universali in PVC cuciti e bordati, provvisti di lacci per chiusura e fori anticondensa.

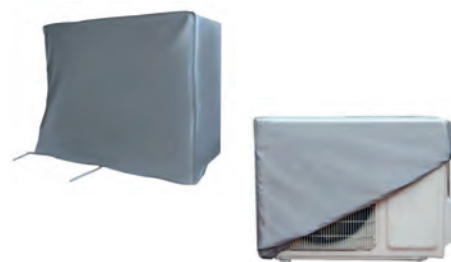

	codice	Dimensioni (mm)	adattabilità unità	UM	min. ord. conf.	cat.	prezzo (€)
●	5850082	L860 x H650 x P350	Dual	NR	1	06	30,02
●	5850084	L950 x H750 x P400	Quadri	NR	1	06	34,78

CLIMAFOAM SPRAY

Detergente schiumogeno per condizionatori per la pulizia dei pacchi alettati e dei filtri delle unità interne degli impianti di aria condizionata. Disgrega lo sporco ed emulsionandolo permette di eliminarlo facilmente.



	codice	contenuto (ml)	UM	min. ord. conf.	cat.	prezzo (€)
●	2006010	500	NR	12	02	19,75

CONDIBAT SPRAY

Sanificante e igienizzante per condizionatori, fan coil e piccoli ambienti in soluzione alcolica >70% in combinazione con sostanze fenoliche. Testato secondo il metodo UNI EN 1040:2005



PROPRIETA' CHIMICO FISICHE	VALORI
Forma	Aerosol
Colore	Incolore
Odore	Fiori di campo
pH	11,25 ± 0,25
Solubilità/Miscibilità acqua	Poco solubile
VOC [%]	50,40

	codice	contenuto (ml)	UM	min. ord. conf.	cat.	prezzo (€)
●	2006011	500	NR	12	02	25,94

NASTRO ADESIVO ANTICONDENSA

In elastomero

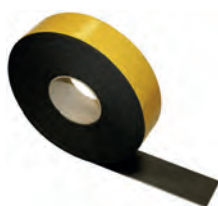

	codice	spess. (mm)	altezza (mm)	lungh. (mt)	UM	min. ord. conf.	cat.	prezzo (€)
●	2006341	3	50	10	NR	24	19	6,95
●	2006340	3	50	15	NR	12	19	11,55

CURVETTA IN PP

Per sifone scarico condensa esterno (2401001)



	codice	sigla	Ø	UM	min. ord. conf.	cat.	prezzo (€)
●	2661017	2111.100.4.	1"	NR	10	20	3,43

ACCESSORI CONDIZIONAMENTO

RACCORDERIA A PRESSURE IN RAME ARIA CONDIZIONATA E REFRIGERAZIONE



Conforme alla normativa EN 378-2
Elastomero in HNBR nero (EN549)

- Misure in pollici
- Profilo di pressatura BMP

Raccordi in rame per aria condizionata e refrigerazione fino a 48 bar, vuoto 200 micron, temperatura -40°C / +121°C.

CURVA A 90° M/F



codice	sigla	Ø	UM	min. ord. conf.	cat.	prezzo (€)
6750001	MPA5001 0030001	3/8"	NR	3	10	19,54
6750002	MPA5001 0040001	1/2"	NR	3	10	21,08
6750003	MPA5001 0050001	5/8"	NR	3	10	23,44
6750004	MPA5001 0060001	3/4"	NR	3	10	26,57
6750005	MPA5001 0070001	7/8"	NR	3	10	28,14
6750006	MPA5001 0080001	1"	NR	2	10	37,52
6750007	MPA5001 0090001	1"1/8	NR	2	10	39,06
6750008	MPA5001 0110001	1"3/8	NR	1	10	84,36

CURVA A 90° F/F



codice	sigla	Ø	UM	min. ord. conf.	cat.	prezzo (€)
6751001	MPA5002 0020001	1/4"	NR	5	10	24,22
6751002	MPA5002 0030001	3/8"	NR	5	10	25,00
6751003	MPA5002 0040001	1/2"	NR	3	10	26,57
6751004	MPA5002 0050001	5/8"	NR	3	10	29,29
6751005	MPA5002 0060001	3/4"	NR	3	10	32,42
6751006	MPA5002 0070001	7/8"	NR	3	10	33,60
6751007	MPA5002 0080001	1"	NR	2	10	35,95
6751008	MPA5002 0090001	1"1/8	NR	2	10	40,63
6751009	MPA5002 0110001	1"3/8	NR	1	10	60,26

CURVA A 45° F/F



codice	sigla	Ø	UM	min. ord. conf.	cat.	prezzo (€)
6752001	MPA5041 0020001	1/4"	NR	3	10	19,54
6752002	MPA5041 0030001	3/8"	NR	3	10	19,54
6752003	MPA5041 0040001	1/2"	NR	3	10	22,65
6752004	MPA5041 0050001	5/8"	NR	3	10	25,00
6752005	MPA5041 0060001	3/4"	NR	3	10	30,46
6752006	MPA5041 0070001	7/8"	NR	3	10	32,03
6752007	MPA5041 0080001	1"	NR	2	10	35,17
6752008	MPA5041 0090001	1"1/8	NR	2	10	37,52
6752009	MPA5041 0110001	1"3/8	NR	2	10	83,64

MANICOTTO CON BATTUTA F/F



codice	sigla	Ø	UM	min. ord. conf.	cat.	prezzo (€)
6756001	MPA5270 0020001	1/4"	NR	5	10	17,19
6756002	MPA5270 0030001	3/8"	NR	5	10	18,76
6756003	MPA5270 0040001	1/2"	NR	5	10	18,76
6756004	MPA5270 0050001	5/8"	NR	5	10	19,54
6756005	MPA5270 0060001	3/4"	NR	2	10	21,08
6756006	MPA5270 0070001	7/8"	NR	2	10	23,04
6756007	MPA5270 0080001	1"	NR	2	10	25,00
6756008	MPA5270 0090001	1"1/8	NR	2	10	28,14
6756009	MPA5270 0110001	1"3/8	NR	2	10	38,84

MANICOTTO PASSANTE F/F



codice	sigla	Ø	UM	min. ord. conf.	cat.	prezzo (€)
6758001	MPA5275L0020001	1/4"	NR	5	10	23,86
6758002	MPA5275L0030001	3/8"	NR	5	10	27,86
6758003	MPA5275L0040001	1/2"	NR	5	10	21,34
6758004	MPA5275L0050001	5/8"	NR	3	10	26,26
6758005	MPA5275L0060001	3/4"	NR	2	10	28,98
6758006	MPA5275L0070001	7/8"	NR	2	10	37,16
6758007	MPA5275L0080001	1"	NR	1	10	45,72
6758008	MPA5275L0090001	1"1/8	NR	1	10	51,02

ACCESSORI CONDIZIONAMENTO

RACCORDERIA A PRESSARE IN RAME ARIA CONDIZIONATA E REFRIGERAZIONE

MANICOTTO RIDOTTO F/F



codice	sigla	Ø	UM	min. ord. conf.	cat.	prezzo (€)
6753001	MPA5240 0030201	3/8"x1/4"	NR	2	10	25,90
6753002	MPA5240 0040201	1/2"x1/4"	NR	2	10	27,33
6753003	MPA5240 0040301	1/2"x3/8"	NR	2	10	33,60
6753020	MPA5240 0050201	5/8"x1/4"	NR	2	10	34,19
6753004	MPA5240 0050301	5/8"x3/8"	NR	2	10	34,38
6753005	MPA5240 0050401	5/8"x1/2"	NR	2	10	35,95
6753006	MPA5240 0060301	3/4"x3/8"	NR	2	10	38,67
6753007	MPA5240 0060401	3/4"x1/2"	NR	2	10	34,75
6753008	MPA5240 0060501	3/4"x5/8"	NR	2	10	36,34
6753009	MPA5240 0070401	7/8"x1/2"	NR	2	10	40,63
6753010	MPA5240 0070501	7/8"x5/8"	NR	2	10	41,41
6753011	MPA5240 0070601	7/8"x3/4"	NR	2	10	43,76
6753012	MPA5240 0080601	1"x3/4"	NR	1	10	44,55
6753013	MPA5240 0090501	1"1/8x5/8"	NR	1	10	46,90
6753014	MPA5240 0090601	1"1/8x3/4"	NR	1	10	48,44
6753015	MPA5240 0090701	1"1/8x7/8"	NR	1	10	53,14
6753016	MPA5240 0090801	1"1/8x1"	NR	1	10	55,36
6753017	MPA5240 0110701	1"3/8x7/8"	NR	1	10	62,72
6753018	MPA5240 0110801	1"3/8x1"	NR	1	10	65,58
6753019	MPA5240 0110901	1"3/8x1"1/8"	NR	1	10	67,26

MANICOTTO RIDOTTO M/F



codice	sigla	Ø	UM	min. ord. conf.	cat.	prezzo (€)
6755001	MPA5243 0030201	3/8"x1/4"	NR	2	10	21,08
6755002	MPA5243 0040301	1/2"x3/8"	NR	2	10	20,33
6755003	MPA5243 0050301	5/8"x3/8"	NR	2	10	19,15
6755004	MPA5243 0050401	5/8"x1/2"	NR	2	10	19,15
6755005	MPA5243 0060501	3/4"x5/8"	NR	2	10	25,79
6755006	MPA5243 0070401	7/8"x1/2"	NR	2	10	21,08
6755007	MPA5243 0070501	7/8"x5/8"	NR	2	10	22,65
6755009	MPA5243 0070601	7/8"x3/4"	NR	2	10	23,44
6755010	MPA5243 0090401	1"1/8x1/2"	NR	1	10	27,36
6755011	MPA5243 0090501	1"1/8x5/8"	NR	1	10	28,92
6755012	MPA5243 0090601	1"1/8x3/4"	NR	1	10	30,46
6755013	MPA5243 0090701	1"1/8x7/8"	NR	1	10	32,82
6755014	MPA5243 0110701	1"3/8x7/8"	NR	1	10	59,36
6755015	MPA5243 0110801	1"3/8x1"	NR	1	10	60,93
6755016	MPA5243 0110901	1"3/8x1"1/8"	NR	1	10	70,87

TAPPO F



codice	sigla	Ø	UM	min. ord. conf.	cat.	prezzo (€)
6763001	MPA5301 0020001	1/4"	NR	3	10	19,54
6763002	MPA5301 0030001	3/8"	NR	3	10	20,33
6763003	MPA5301 0040001	1/2"	NR	3	10	22,65
6763004	MPA5301 0050001	5/8"	NR	2	10	27,36
6763005	MPA5301 0060001	3/4"	NR	2	10	31,25
6763006	MPA5301 0070001	7/8"	NR	2	10	35,17
6763007	MPA5301 0080001	1"	NR	1	10	39,06
6763008	MPA5301 0090001	1"1/8"	NR	1	10	42,98
6763009	MPA5301 0110001	1"3/8"	NR	1	10	48,83

MISURATORE DI PROFONDITÀ E PENNARELLO



codice	sigla	Ø	UM	min. ord. conf.	cat.	prezzo (€)
6766001	MPA DEPTH GAUGE	1/4" - 1"3/8"	NR	1	10	18,93

LUBRIFICANTE PER O-RING 100ml



codice	sigla	UM	min. ord. conf.	cat.	prezzo (€)	
6766002	MPABPSOIL100ML	NR	1	25	10	27,52

TEE F/F/F



codice	sigla	Ø	UM	min. ord. conf.	cat.	prezzo (€)
6764001	MPA5T 002020201	1/4"	NR	3	10	35,95
6764002	MPA5T 003030301	3/8"	NR	3	10	38,28
6764003	MPA5T 004040401	1/2"	NR	3	10	40,63
6764004	MPA5T 005050501	5/8"	NR	2	10	43,76
6764005	MPA5T 006060601	3/4"	NR	2	10	46,90
6764006	MPA5T 007070701	7/8"	NR	2	10	49,22
6764007	MPA5T 008080801	1"	NR	1	10	51,58
6764008	MPA5T 009090901	1"1/8"	NR	1	10	56,25
6764009	MPA5T 011111101	1"3/8"	NR	1	10	91,36

MANICOTTO CARTELLATO IN RAME, DADO GIREVOLE IN OTTONE



codice	sigla	Ø	UM	min. ord. conf.	cat.	prezzo (€)
6759001	MPA5285G0020201	1/4"	NR	4	10	25,37
6759002	MPA5285G0030301	3/8"	NR	4	10	33,74
6759003	MPA5285G0040401	1/2"	NR	2	10	42,03
6759004	MPA5285G0050501	5/8"	NR	2	10	49,59
6759005	MPA5285G0060601	3/4"	NR	2	10	64,79

CATALOGO
LISTINO N° 8

RISCALDAMENTO

SCALDABAGNI	246
TERMOARREDO ELETTRICO	254
TERMOARREDO	257
RADIATORI IN ALLUMINIO	262
ACCESSORI RADIATORI	279
CIRCOLATORI	283
ACCESSORI SOTTOCALDAIA	284
RIDUTTORI DI PRESSIONE	289
MANOMETRI E TERMOMETRI	290



SCALDABAGNI

SCALDABAGNI A GAS

PEGASO ECO - CAMERA APERTA

Scaldabagno murale a gas istantaneo, a camera aperta e tiraggio naturale, a potenza termica modulante con emissione di fumi di tipo LOW Nox - Classe 6. Idoneo per installazione solo interna. Scambiatore in rame a tubi alettati, finiti esternamente con un trattamento anticorrosione in alluminio. Funzionamento a Metano e GPL; può funzionare anche ad aria propanata (50% aria - 50% propano) a seguito della trasformazione da parte del Servizio Tecnico Autorizzato (a pagamento). Compatibile con gli impianti solari termici. Pressione max d'esercizio 10 bar. Regolazione temperatura sanitaria da 40°C a 65°C. Uscita fumi: Modello 11 Ø 110 mm, Modello 14 Ø 130 mm.



NOVITÀ!

ERP

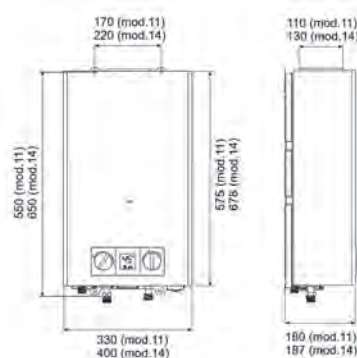

codice	sigla	modello	versione	Classe ERP	Portata termica nominale (Kw)	Potenza utile (Kw)	Produzione sanitaria (lit/min)		profilo di carico	UM	min. ord. conf.	cat.	prezzo (€)
							Δt 25°C	Δt 30°C					
6176001	GCC1MKAA	11	Metano	A	21,1	7,1 - 18,8	11,0	9,1	M	NR	1	13	381,92
6176002	GCC1MLAA	11	GPL	A	21,1	7,1 - 18,8	11,0	9,1	M	NR	1	13	381,92
6176003	GCC1PKAA	14	Metano	A	26,8	9,5 - 23,7	13,9	11,3	M	NR	1	13	487,08
6176004	GCC1PLAA	14	GPL	A	26,8	9,5 - 23,7	13,9	11,3	M	NR	1	13	487,08

KONA - CAMERA STAGNA

Scaldabagno murale a gas istantaneo a camera stagna e tiraggio forzato, a potenza termica modulante e controllo elettronico della combustione con emissione di fumi di tipo LOW Nox - Classe 6. Idoneo per installazione interna o esterna in un luogo parzialmente protetto (fino a -15°C con l'installazione del kit resistenze antigelo opzionale [2008096]; protezione dei tubi di entrata ed uscita acqua sanitaria a cura dell'installatore). Funzionamento a Metano e GPL; può funzionare anche ad aria propanata (50% aria - 50% propano) a seguito della trasformazione da parte del Servizio Tecnico Autorizzato (a pagamento). Compatibile con gli impianti solari termici. Pressione max d'esercizio 10 bar. Regolazione temperatura sanitaria da 40°C a 65°C. Uscita fumi: Coassiale Ø 60/100 mm, Sdoppiato Ø 80 mm.



NOVITÀ!

ERP

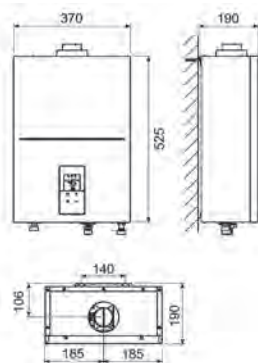

codice	sigla	modello	versione	Classe ERP	Portata termica nominale (Kw)	Potenza utile (Kw)	Produzione sanitaria (lit/min)		Profilo di carico	min. ord.	min. ord. conf.	cat.	prezzo (€)
							Δt 25°C	Δt 30°C					
6177003	ODK96IAA	12	Metano	A	23	3,6 - 20,9	12	10,0	XL	NR	1	13	722,32
6177004	ODK96KAA	12	GPL	A	23	3,6 - 20,9	12	10,0	XL	NR	1	13	722,32
6177001	ODK95IAA	15	Metano	A	29,7	3,6 - 27,0	15,5	12,9	XL	NR	1	13	774,90
6177002	ODK95KAA	15	GPL	A	29,7	3,6 - 27,0	15,5	12,9	XL	NR	1	13	774,90
6177005	ODK97IAA	17	Metano	A	33	3,6 - 30,0	17	14,3	XL	NR	1	13	821,95
6177006	ODK97KAA	17	GPL	A	33	3,6 - 30,0	17	14,3	XL	NR	1	13	821,95

KIT SDOPPIATORE



NOVITÀ!

codice	sigla	∅	UM	min. ord. conf.	cat.	prezzo (€)
2008090	010039X0	80 - 80	NR	1	11	90,83

KIT ATTACCO VERTICALE COASSIALE



NOVITÀ!

codice	sigla	∅	UM	min. ord. conf.	cat.	prezzo (€)
2008091	010037X0	60 - 100	NR	1	11	43,85

KIT ASPIRAZIONE/SCARICO COASSIALE

Lunghezza 1 metro.



NOVITÀ!

codice	sigla	∅	UM	min. ord. conf.	cat.	prezzo (€)
2008092	010040X0	60 - 100	NR	1	11	84,56

TUBO COASSIALE CON TERMINALE E GUARNIZIONE

Interno in alluminio, esterno materiale plastico. Lunghezza 1 metro.



NOVITÀ!

codice	sigla	∅	UM	min. ord. conf.	cat.	prezzo (€)
2008093	1KWMA56A	60 - 100	NR	1	11	43,85

PROLUNGA COASSIALE MASCHIO/FEMMINA CON GUARNIZIONI

Interno in alluminio, esterno materiale plastico. Lunghezza 1 metro.



NOVITÀ!

codice	sigla	∅	UM	min. ord. conf.	cat.	prezzo (€)
2008094	1KWMA56U	60 - 100	NR	1	11	34,45

CURVA COASSIALE CON GUARNIZIONI



NOVITÀ!

codice	sigla	∅	UM	min. ord. conf.	cat.	prezzo (€)
2008095	1KWMA81W	60 - 100	NR	1	11	31,32

KIT RESISTENZE ELETTRICHE

Per antigelo ausiliario (on +5°C / off +15°C).



NOVITÀ!

codice	sigla	UM	min. ord. conf.	cat.	prezzo (€)
2008096	013027X0	NR	1	11	106,49

SCALDABAGNI

SCALDABAGNI A POMPA DI CALORE

EGEA TECH LT - INSTALLAZIONE CON TEMPERATURE ARIA NEGATIVE

Pompa di calore ad aria con serbatoio d'accumulo integrato in acciaio smaltato con isolamento in poliuretano da 50 mm., scambiatore di calore principale in alluminio esterno al serbatoio, doppio anodo di magnesio anticorrosione (mod.200-260 litri). Possibilità di canalizzare l'aria sia in ingresso che in uscita. **Sistema defrosting attivo per il funzionamento corretto fino a -7°C (-5°C Mod. 90-120 litri).** Modulo Wi-Fi e controllo tramite smartphone mediante un'app per gestire le 5 modalità operative disponibili. Ciclo antilegionella programmabile. Predisposto per la connessione ad un impianto fotovoltaico. Funzionamento in cascata auto-configurabile: la nuova elettronica permette di realizzare e gestire una cascata fino a nr. 8 EGEA TECH a basamento senza alcun regolatore esterno.

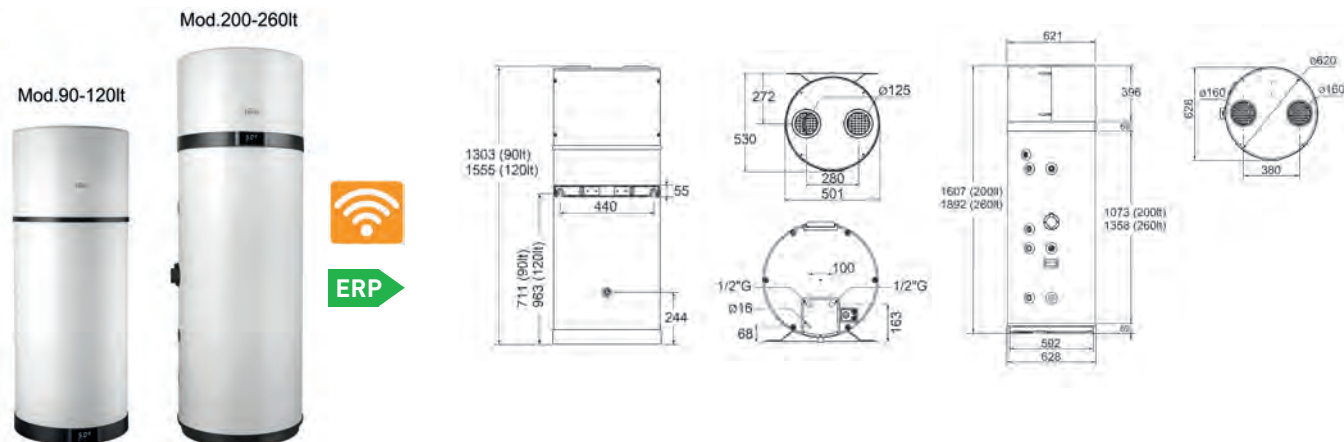

codice	sigla	TIPO	LITRI	Classe ERP	Watt	Profilo di carico	Tipo di gas	UM	min. ord. conf.	cat.	prezzo (€)
6175001	2CP0020F	Pensile	90	A+	1200	M	R290	NR	1	17	2.025,40
6175002	2CP0021F	Pensile	120	A+	1200	M	R290	NR	1	17	2.118,68
6175003	2CP0024F	A basamento	200	A+	1500	L	R134A	NR	1	17	3.445,85
6175004	2CP0025F	A basamento	260	A+	1500	XL	R134A	NR	1	17	3.539,12

VERSIONE LT-S PREDISPOSTO PER SOLARE TERMICO

Con serpentino interno per solare, questa versione è abbinabile ad un impianto solare termico a circolazione forzata. L'elettronica è in grado di gestire direttamente i componenti del circuito solare se non gestiti da una propria centralina.

codice	TIPO	TIPO	LITRI	Classe ERP	Watt	Profilo di carico	Tipo di gas	UM	min. ord. conf.	cat.	prezzo (€)
6175005	2CP0026F	A basamento	200	A+	1500	L	R134A	NR	1	10	3.651,05
6175006	2CP0027F	A basamento	260	A+	1500	XL	R134A	NR	1	10	3.731,00

EGEA TECH HT - INSTALLAZIONE CON TEMPERATURE ARIA POSITIVE

Pompa di calore ad aria con serbatoio d'accumulo integrato in acciaio smaltato con isolamento in poliuretano da 50 mm., scambiatore di calore principale in alluminio esterno al serbatoio, doppio anodo di magnesio anticorrosione. Possibilità di canalizzare l'aria sia in ingresso che in uscita. **Campo di temperatura dell'aria in ingresso non inferiore a 4°C.** Modulo Wi-Fi e controllo tramite smartphone mediante un'app per gestire le 5 modalità operative disponibili. Ciclo antilegionella programmabile. Predisposto per la connessione ad un impianto fotovoltaico. Funzionamento in cascata auto-configurabile: la nuova elettronica permette di realizzare e gestire una cascata fino a nr. 8 EGEA TECH a basamento senza alcun regolatore esterno.

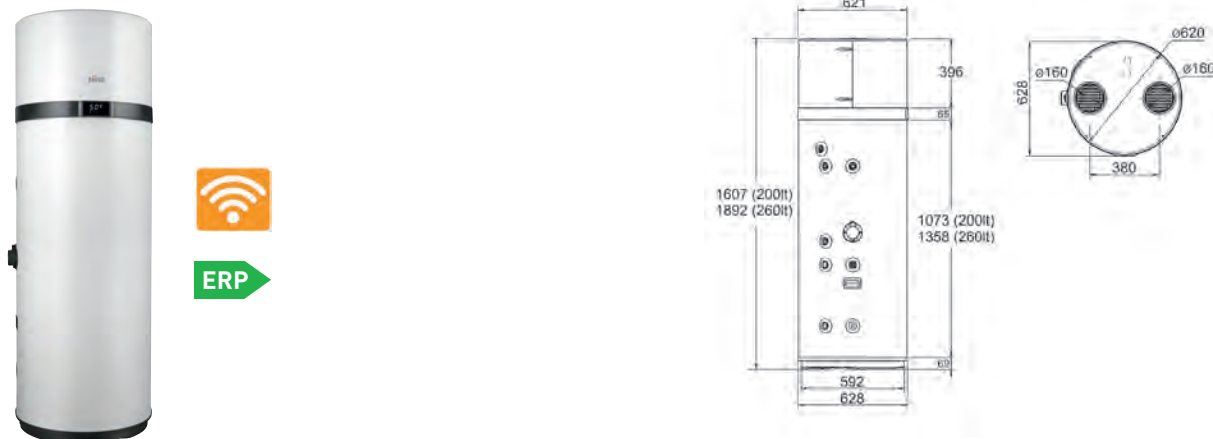

codice	sigla	TIPO	LITRI	Classe ERP	Watt	Profilo di carico	Tipo di gas	UM	min. ord. conf.	cat.	prezzo (€)
6175007	2CP0022F	A basamento	200	A+	1500	L	R134A	NR	1	17	2.686,32
6175008	2CP0023F	A basamento	260	A+	1500	XL	R134A	NR	1	17	2.798,25

TITANO TWIN - GARANZIA 5 ANNI

Ultrasottile, installazione sia verticale che orizzontale (in questo caso solo attacchi a sinistra). Doppio serbatoio con doppio anodo di magnesio (uno per serbatoio). Dotato di resistenza elettrica ultraperformante con speciale trattamento superficiale che riduce quasi del tutto le incrostazioni. Modulo Wi-Fi e controllo tramite App. Ciclo antilegionella in modo autonomo. Valvola di sicurezza tarata 8 bar.

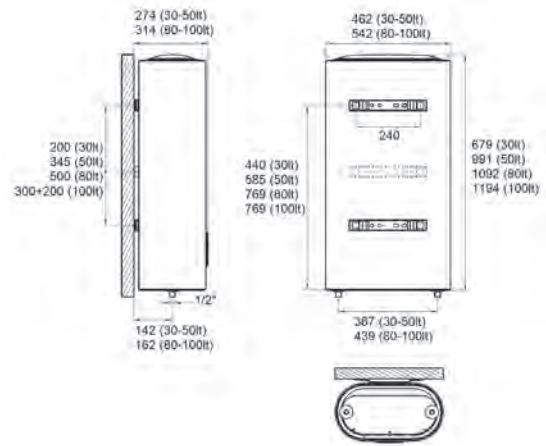

codice	sigla	TIPO	LITRI	Classe ERP	Watt	Profilo di carico	UM	min. ord. conf.	cat.	prezzo (€)
6174001	GRZ52DKA	Verticale/Orizzontale	30	A	1800	S	NR	1	10	374,98
6174002	GRZ54DKA	Verticale/Orizzontale	50	B	1800	M	NR	1	10	447,55
6174003	GRZ56JKA	Verticale/Orizzontale	80	B	1800	M	NR	1	10	544,32
6174004	GRZ57JKA	Verticale/Orizzontale	100	B	1800	M	NR	1	10	574,56

TITANO SMART - GARANZIA 5 ANNI

Dotato di resistenza elettrica ultraperformante con speciale trattamento superficiale che riduce quasi del tutto le incrostazioni. Anodo di magnesio a protezione del serbatoio. Flangia a 5 bulloni, valvola di sicurezza tarata a 8 bar. A corredo cavo elettrico tripolare senza spina. Nella versione orizzontale, la resistenza è solo a destra.

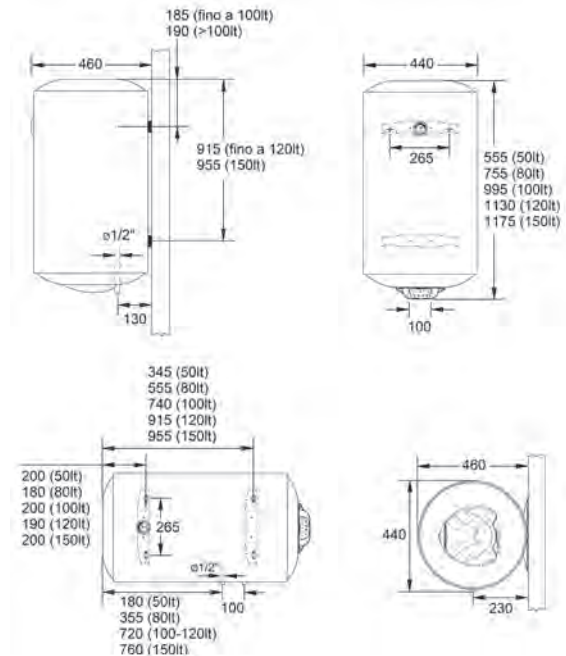

codice	TIPO	LITRI	Classe ERP	Watt	Profilo di carico	UM	min. ord. conf.	cat.	prezzo (€)
6173001	Verticale	50	B	1200	M	NR	1	10	275,18
6173002	Verticale	80	B	1200	M	NR	1	10	296,35
6173003	Verticale	100	B	1500	M	NR	1	10	323,57
6173004	Verticale	120	C	1500	L	NR	1	10	381,02
6173005	Verticale	150	C	1500	L	NR	1	10	423,36
6173006	Orizzontale	50	B	1200	M	NR	1	10	337,18
6173007	Orizzontale	80	B	1200	M	NR	1	10	359,86
6173008	Orizzontale	100	B	1500	M	NR	1	10	393,12
6173009	Orizzontale	120	C	1500	L	NR	1	10	438,48
6173010	Orizzontale	150	C	1500	L	NR	1	10	450,58

SCALDABAGNI

SCALDABAGNI ELETTRICI

VERTICALE - GARANZIA 5 ANNI

Realizzati in acciaio di alta qualità, trattamento interno di vetroporcellanatura in polvere, isolamento in schiuma poliuretanicopriva di CFC. Dotato di resistenza elettrica ultraperformante con speciale trattamento superficiale che riduce quasi del tutto le incrostazioni. Controllo termostatico a sonda. Anodo di magnesio a protezione del serbatoio. Flangia a 5 bulloni. Indicatore livello di temperatura e spia on/off. Valvola di sicurezza tarata a 8 bar.



ERP

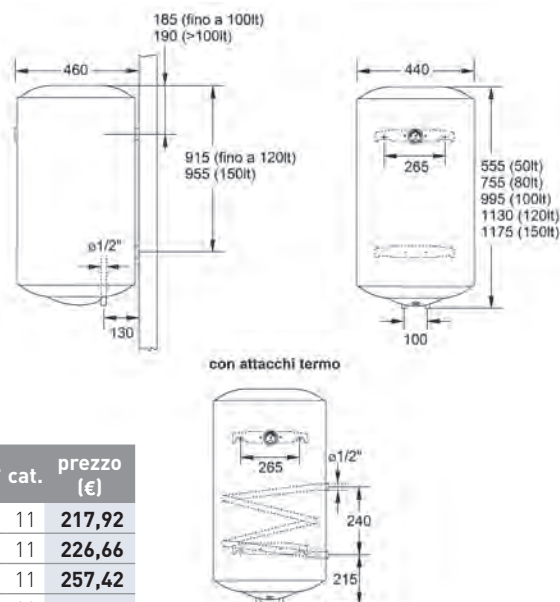

codice	TIPO	LITRI	Classe ERP	Watt	Profilo di carico	UM	min. ord. conf.	cat.	prezzo (€)
6170001	Verticale	50	C	1200	M	NR	1	11	217,92
6170002	Verticale	80	C	1200	L	NR	1	11	226,66
6170003	Verticale	100	C	1500	L	NR	1	11	257,42
6170006	Verticale	120	C	1500	L	NR	1	11	335,66
6170007	Verticale	150	C	1500	L	NR	1	11	385,80
6170004	Termoelettrico - attacchi DX	80	C	1200	L	NR	1	11	323,88
6170005	Termoelettrico - attacchi SX	80	C	1200	L	NR	1	11	323,88

ORIZZONTALE - GARANZIA 5 ANNI

Realizzati in acciaio di alta qualità, trattamento interno di vetroporcellanatura in polvere, isolamento in schiuma poliuretanicopriva di CFC. Dotato di resistenza elettrica ultraperformante con speciale trattamento superficiale che riduce quasi del tutto le incrostazioni. Controllo termostatico a sonda. Anodo di magnesio a protezione del serbatoio. Flangia a 5 bulloni. Indicatore livello di temperatura e spia on/off. Valvola di sicurezza tarata a 8 bar.



ERP

VERSIONE RESISTENZA DESTRA

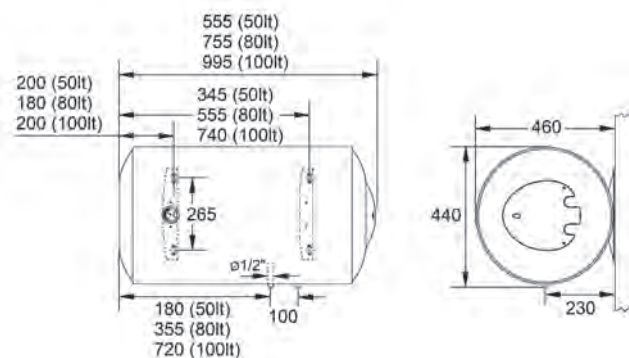

codice	TIPO	LITRI	Classe ERP	Watt	Profilo di carico	UM	min. ord. conf.	cat.	prezzo (€)
6172005	Resistenza DESTRA	50	C	1200	M	NR	1	11	267,60
6172006	Resistenza SINISTRA	50	C	1200	M	NR	1	11	267,60
6172001	Resistenza DESTRA	80	C	1200	M	NR	1	11	276,37
6172002	Resistenza SINISTRA	80	C	1200	M	NR	1	11	276,37
6172003	Resistenza DESTRA	100	C	1500	L	NR	1	11	342,17
6172004	Resistenza SINISTRA	100	C	1500	L	NR	1	11	342,17
6171006	Termoelettrico - attacchi DX	80	C	1200	M	NR	1	11	343,96
6171007	Termoelettrico - attacchi SX	80	C	1200	M	NR	1	11	343,96

PICCOLI LITRAGGI - GARANZIA 5 ANNI

Bollitore vetroporcellanato con trattamento igienizzante. Resistenza elettrica in acciaio inossidabile. Anodo di magnesio. Regolatore della temperatura esterno con indicatore della potenza a led. Involucro esterno in ABS. Termostato a capillare per il controllo della temperatura.



ERP →

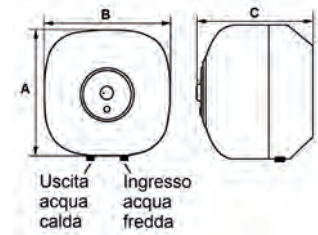

codice	TIPO	LITRI	Classe ERP	Watt	Profilo di carico	UM	min. ord. conf.	cat.	prezzo (€)
6171001	SOPRA lavello	10	B	1500	XXS	NR	1	11	164,77
6171002	SOTTO lavello	10	B	1500	XXS	NR	1	11	173,01
6171003	SOPRA lavello	15	B	1500	XXS	NR	1	11	179,59
6171004	SOTTO lavello	15	B	1500	XXS	NR	1	11	187,89
6171005	SOPRA lavello	30	C	1500	S	NR	1	11	218,61

codice	A	B	C
6171001	240	291	347
6171002	240	291	347
6171003	360	329	375
6171004	360	329	375
6171005	440	389	455

VERTICALE - GARANZIA 2 ANNI

Realizzati in acciaio di alta qualità, trattamento interno di vetroporcellanatura in polvere, isolamento in schiuma poliuretanicopriva di CFC. Dotato di resistenza elettrica in acciaio inossidabile, flangia 5 bulloni. Controllo termostatico a sonda. Anodo di magnesio a protezione del serbatoio. Indicatore livello di temperatura e spia on/off. Valvola di sicurezza tarata a 8 bar.



ERP →

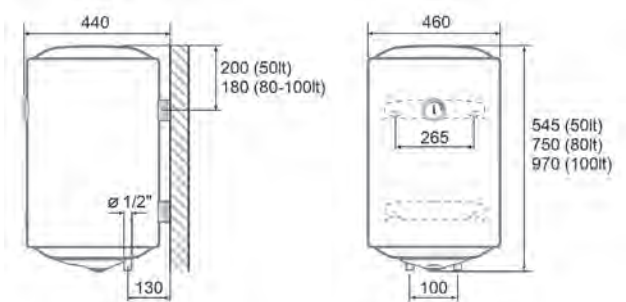

codice	TIPO	LITRI	Classe ERP	Watt	Profilo di carico	UM	min. ord. conf.	cat.	prezzo (€)
6160001	Verticale	50	C	1200	M	NR	1	11	185,75
6160002	Verticale	80	C	1200	L	NR	1	11	194,88
6160003	Verticale	100	C	1500	L	NR	1	11	240,56

PICCOLI LITRAGGI - GARANZIA 2 ANNI

Bollitore vetroporcellanato con trattamento igienizzante. Resistenza elettrica in acciaio inossidabile, flangia 5 bulloni. Anodo di magnesio. Regolatore della temperatura esterno con indicatore della potenza a led. Involucro esterno in ABS. Termostato a capillare per il controllo della temperatura.



ERP →

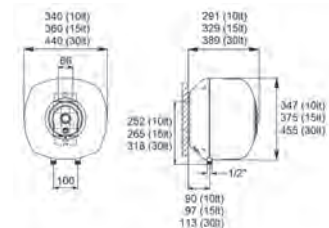

codice	TIPO	LITRI	Classe ERP	Watt	Profilo di carico	UM	min. ord. conf.	cat.	prezzo (€)
6161001	SOPRA lavello	10	B	1500	XXS	NR	1	11	149,21
6161002	SOPRA lavello	15	B	1500	XXS	NR	1	11	161,39
6161003	SOPRA lavello	30	D	1500	D	NR	1	11	188,79

codice	A	B	C
6161001	240	291	347
6161002	360	329	375
6161003	440	389	455

SCALDABAGNI

ACCESSORI E RICAMBI SCALDABAGNI ELETTRICI

RESISTENZE SCALDABAGNI 5 ANNI



codice	descrizione	compatibilità scaldabagno			foto	UM	min. ord. conf.	cat.	prezzo (€)
		modelli	versione						
2008051	Resistenza flangiata 1500w (Conf.5pz)	10-15-30	-	1	CF	1	01	195,60	
2008056	Resistenza flangiata 1200w (Conf.10pz)	50-80	verticale	3	CF	1	01	618,80	
2008060	Resistenza flangiata 1200w (Conf.10pz)	50-80	orizzontale	5	CF	1	01	618,80	
2008057	Resistenza flangiata 1500w (Conf.10pz)	100-120-150	verticale	7	CF	1	01	653,65	
2008061	Resistenza flangiata 1500w (Conf.10pz)	100-120-150	orizzontale	9	CF	1	01	653,65	

RESISTENZE SCALDABAGNI 2 ANNI



codice	descrizione	compatibilità scaldabagno			foto	UM	min. ord. conf.	cat.	prezzo (€)
		modelli	versione						
2008051	Resistenza flangiata 1500w (Conf.5pz)	10-15-30	-	1	CF	1	01	195,60	
2008054	Resistenza flangiata 1200w (Conf.10pz)	50-80	verticale	2	CF	1	01	250,38	
2008058	Resistenza flangiata 1200w (Conf.10pz)	50-80	orizzontale	4	CF	1	01	268,76	
2008055	Resistenza flangiata 1500w (Conf.10pz)	100-120-150	verticale	6	CF	1	01	286,17	
2008059	Resistenza flangiata 1500w (Conf.10pz)	100-120-150	orizzontale	8	CF	1	01	296,22	

ACCESSORI E RICAMBI



codice	descrizione	compatibilità scaldabagno			foto	UM	min. ord. conf.	cat.	prezzo (€)
		modelli	versione	garanzia (Anni)					
2008052	Termostato capillare (Conf.10pz)	10-15-30	-	2-5	1	CF	1	01	107,90
2008062	Termostato (Conf.10pz)	50-80-100-120-150	verticale	2-5	2	CF	1	01	187,15
2008063	Termostato (Conf.10pz)	50-80-100-120-150	orizzontale	2-5	2	CF	1	01	188,86
2008050	Anodo 17 x 130 (Conf.5pz)	10-15-30	-	2-5	3	CF	1	01	19,98
2008064	Anodo 21,3 x 220 (Conf.5pz)	50-80-100-120-150	vertic./orizz.	2-5	3	CF	1	01	66,16
2008065	Valvola di sicurezza 1/2" - 8 bar	tutti	vertic./orizz.	2-5	4	NR	1	01	9,00

RACCORDI PER SCALDABAGNO



Con tubi e squadretta in rame cromato, biconi D. 14

codice	sigla	attacco Ø	UM	min. ord. conf.	cat.	prezzo (€)
2733010	0905R442CR	1/2"x1/2"	NR	1	06	52,38

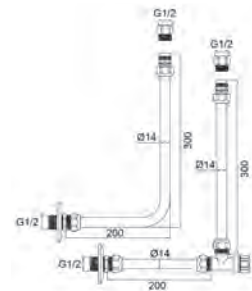

TRADIZIONALE RUBINETTO PER SCALDABAGNO



Incluso tubo di collegamento

codice	UM	min. ord. conf.	cat.	prezzo (€)
3005028	NR	1	20	75,63

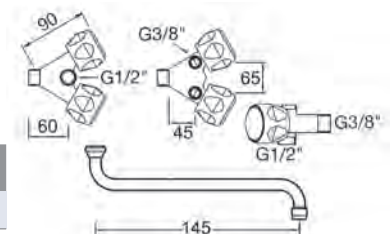

TERMOARREDO ELETTRICO

MODELLO CLOE

ELETTRICO BIANCO LUCIDO

Termoarredo in acciaio al carbonio, collettori laterali Ø 40x30 mm., saldobrasati, con cronotermostato digitale **(solo a destra)**. Con kit di fissaggio incluso. Verniciatura a polveri epossipoliestere. Temperatura max d'esercizio 75°C. Grado protezione IP24. Isolamento elettrico Classe 2. Lunghezza cavo circa 1 mt con spina Schuko. **Installazione solo verticale.**

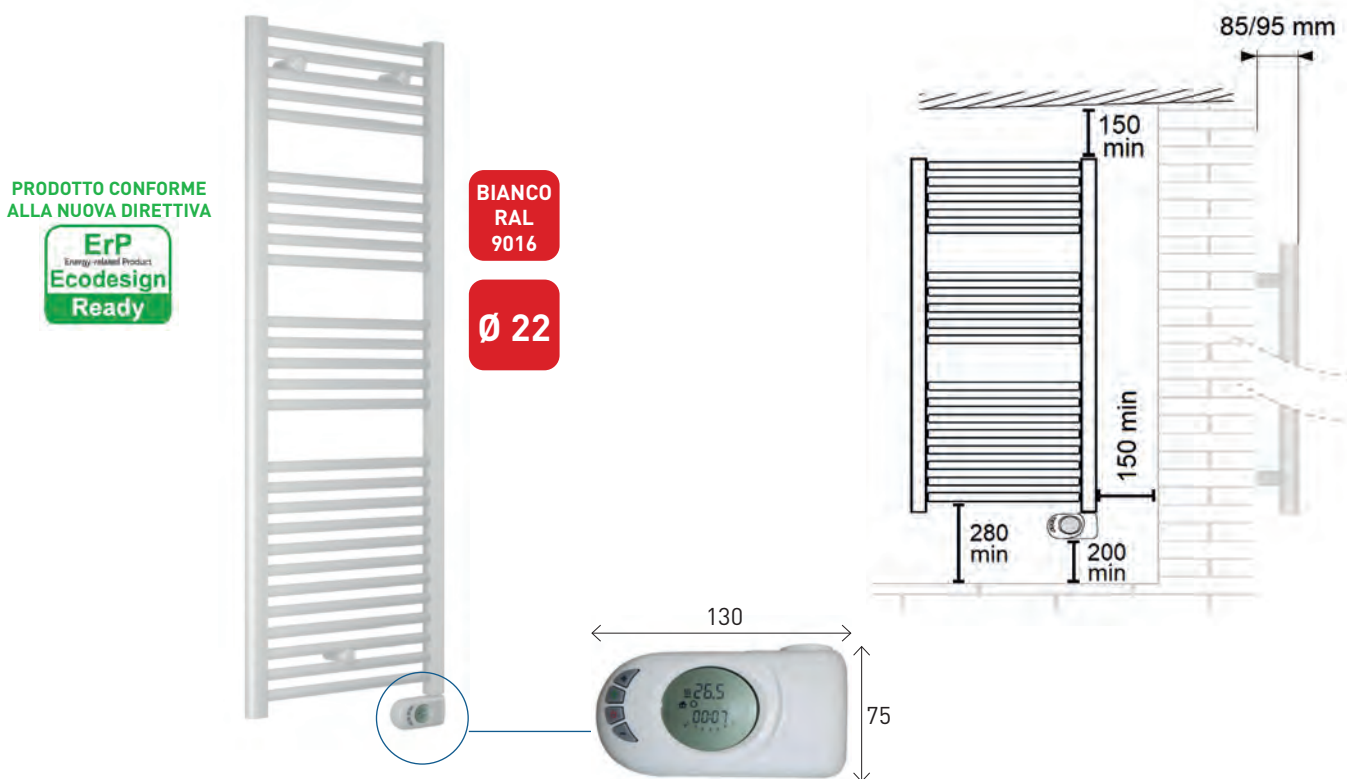

Cronotermostato digitale con sensore per la rilevazione della temperatura ambiente impostata ed ampio display per visualizzare tutte le funzioni (non retroilluminato).

Progettato per essere conforme alla nuova direttiva Europea ErP (Energy-related-Products) per il risparmio energetico.

Il termostato presenta le seguenti modalità di funzionamento:

- Modalità "Comfort": mantenimento della temperatura ambiente impostata dall'utente;
- Modalità "Crono": programmazione del funzionamento giornaliero con ripetizione settimanale;
- Modalità "2h": il radiatore funziona alla massima potenza per 2h indipendentemente dalla temperatura impostata;
- Modalità "Antigelo": mantenimento della temperatura ambiente sempre sopra i 7°C;
- Modalità "Notte": mantenimento della temperatura ambiente ad un valore ridotto rispetto alla temperatura Comfort;
- Rilevamento "Finestra aperta": il termostato si disattiva per un massimo di 30 minuti nel caso di apertura di una finestra all'interno della stanza;

codice	altezza (mm)	larghezza (mm)	peso (kg)	Resistenza (Watt)	UM	min. ord.	pz. pallet	cat.	prezzo (€)
● 6122001	720	400	7,7	300	NR	1	20	02	287,71
● 6122002	920	480	9,4	500	NR	1	20	02	302,06
● 6122003	1375	480	14,7	750	NR	1	20	02	346,77
● 6122004	1703	550	22,1	1000	NR	1	10	02	405,25

ELETTRICO NERO OPACO

Termoarredo in acciaio al carbonio, collettori laterali Ø 40x30 mm., saldobrasati, con cronotermostato digitale **(solo a destra)**. Con kit di fissaggio incluso. Verniciatura a polveri epossipoliestere. Temperatura max d'esercizio 75°C. Grado protezione IP24. Isolamento elettrico Classe 2. Lunghezza cavo circa 1 mt con spina Schuko. **Installazione solo verticale.**

PRODOTTO CONFORME
ALLA NUOVA DIRETTIVA



NERO
RAL
9005

Ø 22

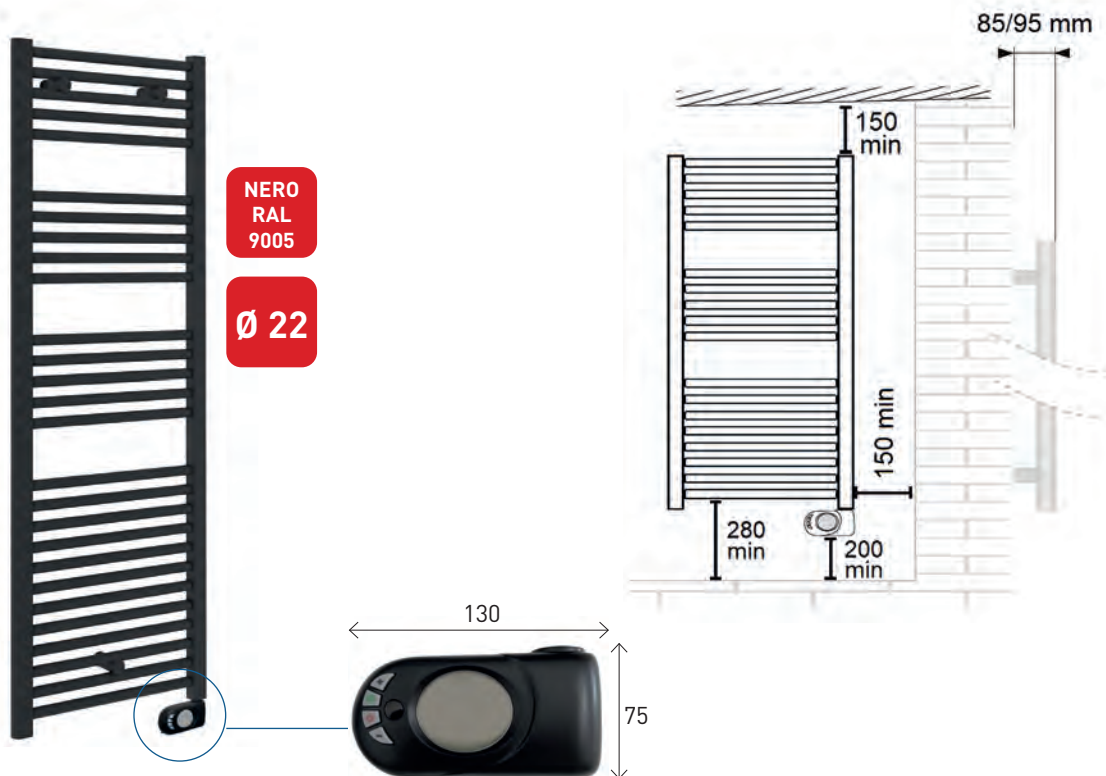

Cronotermostato digitale con sensore per la rilevazione della temperatura ambiente impostata ed ampio display per visualizzare tutte le funzioni (non retroilluminato).

Progettato per essere conforme alla nuova direttiva Europea ErP (Energy-related-Products) per il risparmio energetico.

Il termostato presenta le seguenti modalità di funzionamento:

- Modalità "Comfort": mantenimento della temperatura ambiente impostata dall'utente;
- Modalità "Crono": programmazione del funzionamento giornaliero con ripetizione settimanale;
- Modalità "2h": il radiatore funziona alla massima potenza per 2h indipendentemente dalla temperatura impostata;
- Modalità "Antigelo": mantenimento della temperatura ambiente sempre sopra i 7°C;
- Modalità "Notte": mantenimento della temperatura ambiente ad un valore ridotto rispetto alla temperatura Comfort;
- Rilevamento "Finestra aperta": il termostato si disattiva per un massimo di 30 minuti nel caso di apertura di una finestra all'interno della stanza;

codice	altezza (mm)	larghezza (mm)	peso (kg)	Resistenza (Watt)	UM	min. ord.	pz. pallet	cat.	prezzo (€)
6122901	720	400	7,7	300	NR	1	20	03	289,50
6122902	920	480	9,4	500	NR	1	20	03	308,28
6122903	1375	480	14,7	750	NR	1	20	03	355,20
6122904	1703	550	22,1	1000	NR	1	9	03	387,57

TERMOARREDO ELETTRICO

MODELLO CLOE

ELETTRICO CROMATO

Termoarredo in acciaio al carbonio, collettori laterali Ø 40x30 mm., saldobrasati, con cronotermostato digitale **(solo a destra)**. Con kit di fissaggio incluso. Verniciatura a polveri epossipoliestere. Temperatura max d'esercizio 75°C. Grado protezione IP24. Isolamento elettrico Classe 2. Lunghezza cavo circa 1 mt con spina Schuko. **Installazione solo verticale.**

PRODOTTO CONFORME
ALLA NUOVA DIRETTIVA



CROMATO

Ø 22

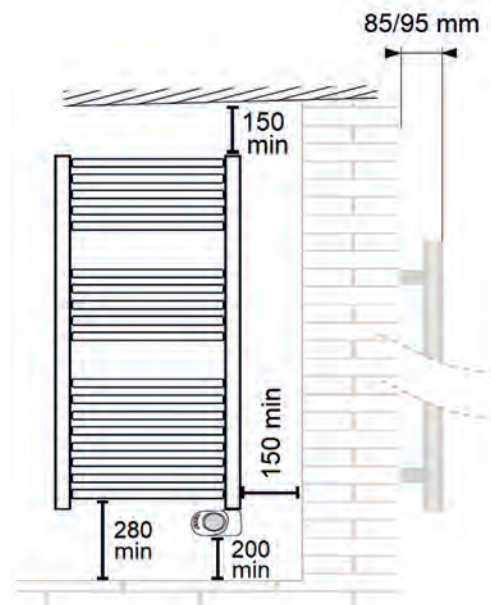

Cronotermostato digitale con sensore per la rilevazione della temperatura ambiente impostata ed ampio display per visualizzare tutte le funzioni (non retroilluminato).

Progettato per essere conforme alla nuova direttiva Europea ErP (Energy-related-Products) per il risparmio energetico.

Il termostato presenta le seguenti modalità di funzionamento:

- Modalità "Comfort": mantenimento della temperatura ambiente impostata dall'utente;
- Modalità "Crono": programmazione del funzionamento giornaliero con ripetizione settimanale;
- Modalità "2h": il radiatore funziona alla massima potenza per 2h indipendentemente dalla temperatura impostata;
- Modalità "Antigelo": mantenimento della temperatura ambiente sempre sopra i 7°C;
- Modalità "Notte": mantenimento della temperatura ambiente ad un valore ridotto rispetto alla temperatura Comfort;
- Rilevamento "Finestra aperta": il termostato si disattiva per un massimo di 30 minuti nel caso di apertura di una finestra all'interno della stanza;

codice	altezza (mm)	larghezza (mm)	peso (kg)	Resistenza (Watt)	UM	min. ord.	pz. pallet	cat.	prezzo (€)
6122011	720	400	7,7	150	NR	1	20	03	411,90
6122012	920	480	9,4	300	NR	1	20	03	462,24
6122013	1375	480	14,7	400	NR	1	20	03	529,59
6122014	1703	550	22,1	600	NR	1	9	03	588,42

BIANCO LUCIDO

Termoarredo in acciaio al carbonio, collettori laterali Ø 40x30 mm., saldobrasati. Con kit di fissaggio incluso.

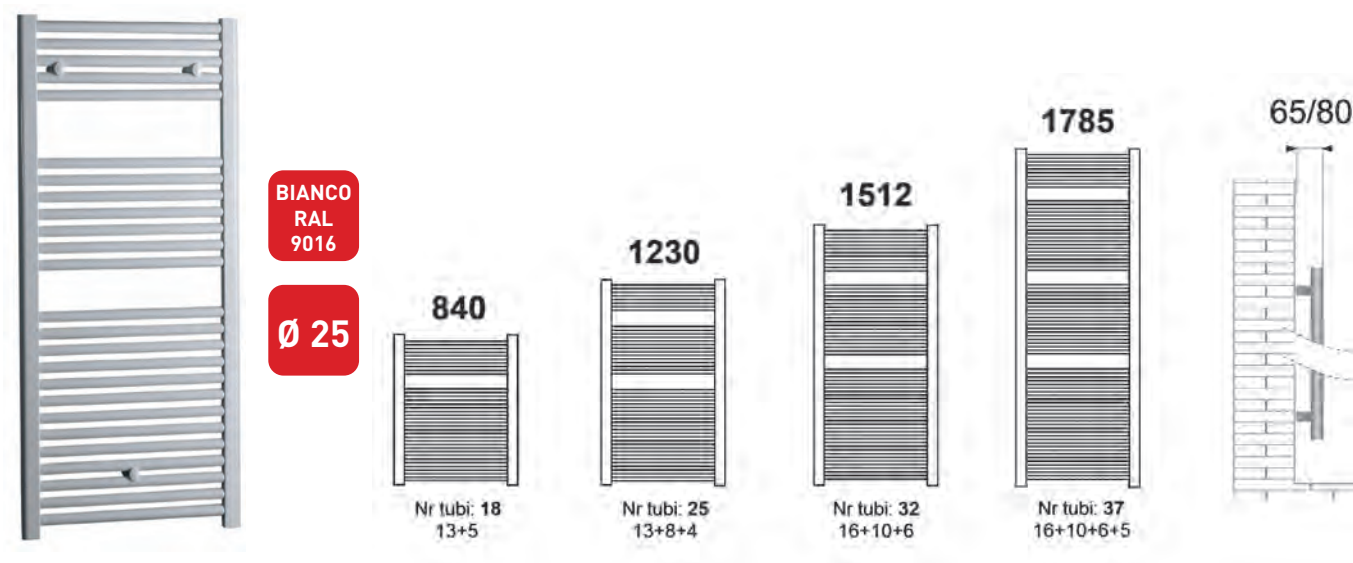

codice	altezza (mm)	larghezza (mm)	interasse (mm)	watt		peso (kg)	contenuto acqua (litri)	Resistenza (Watt)	UM	min. ord.	cat.	prezzo (€)
				Δt 30°C	Δt 50°C							
6101001	840	400	355	184	342	6,3	4,0	300	NR	1	15	101,34
6101002	840	450	405	207	385	6,9	4,4	300	NR	1	15	103,01
6101003	840	500	455	229	426	7,5	4,7	500	NR	1	15	105,23
6101004	840	550	505	251	467	8,0	5,1	500	NR	1	15	106,93
6101005	840	600	555	273	508	8,6	5,5	500	NR	1	15	109,71
6101009	1230	400	355	253	478	9,0	5,6	500	NR	1	15	132,68
6101010	1230	450	405	285	538	9,7	6,2	500	NR	1	15	134,90
6101011	1230	500	455	320	605	10,5	6,7	700	NR	1	15	139,38
6101012	1230	550	505	356	673	11,3	7,2	700	NR	1	15	141,64
6101013	1230	600	555	391	740	12,1	7,8	700	NR	1	15	145,56
6101015	1230	750	705	497	942	14,5	9,3	1000	NR	1	15	171,87
6101017	1512	400	355	310	585	11,2	7,1	700	NR	1	15	153,96
6101018	1512	450	405	348	658	12,3	7,8	700	NR	1	15	157,88
6101019	1512	500	455	390	736	13,3	8,5	700	NR	1	15	160,10
6101020	1512	550	505	430	813	14,3	9,1	700	NR	1	15	163,47
6101021	1512	600	555	471	890	15,3	9,8	1000	NR	1	15	166,28
6101023	1512	750	705	594	1122	18,3	11,8	1000	NR	1	15	202,65
6101025	1785	400	355	370	697	13,1	8,3	700	NR	1	15	189,77
6101026	1785	450	405	416	784	14,3	9,1	700	NR	1	15	192,59
6101027	1785	500	455	458	863	15,4	9,9	1000	NR	1	15	196,51
6101028	1785	550	505	500	942	16,6	10,6	1000	NR	1	15	198,73
6101029	1785	600	555	541	1020	17,8	11,4	1000	NR	1	15	202,65
6101031	1785	750	705	668	1257	21,2	13,8	1000	NR	1	15	236,25

TERMOARREDO

MODELLO GIADA

NERO OPACO

Termoarredo in acciaio al carbonio, collettori laterali Ø 40x30 mm., saldobrasati. Con kit di fissaggio incluso.

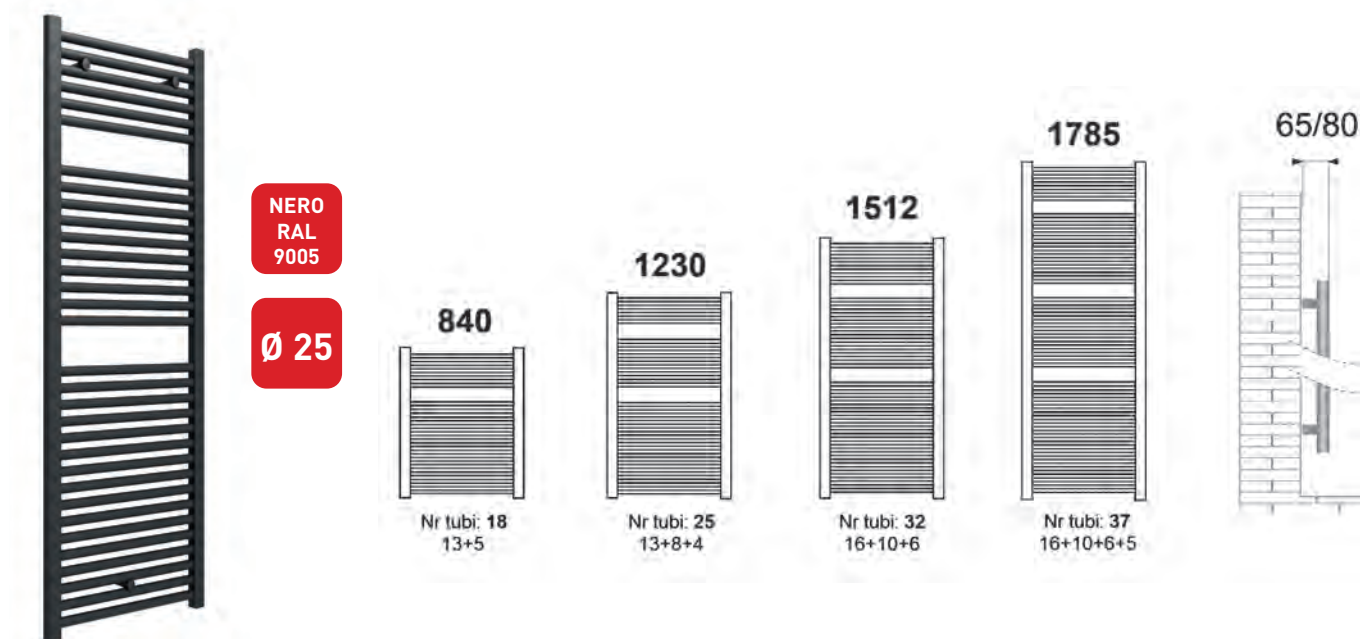

codice	altezza (mm)	larghezza (mm)	interasse (mm)	watt		peso (kg)	contenuto acqua (litri)	Resistenza (Watt)	UM	min. ord.	cat.	prezzo (€)
				Δt 30°C	Δt 50°C							
6101903	840	500	450	229	426	6,9	4,8	500	NR	1	15	180,71
6101911	1230	500	450	320	605	10,0	6,9	700	NR	1	15	239,02
6101919	1512	500	450	390	736	13,2	8,4	700	NR	1	15	274,43
6101927	1785	500	450	458	863	14,2	9,8	1000	NR	1	15	337,14

È POSSIBILE AVERE TUTTE LE VARIANTI DEL MODELLO BIANCO CON SOVRAPPREZZO PER LA VERNICIATURA NERO OPACO.

CROMATO

Termoarredo in acciaio al carbonio, collettori laterali Ø 40x30 mm., saldobrasati. Con kit di fissaggio incluso.

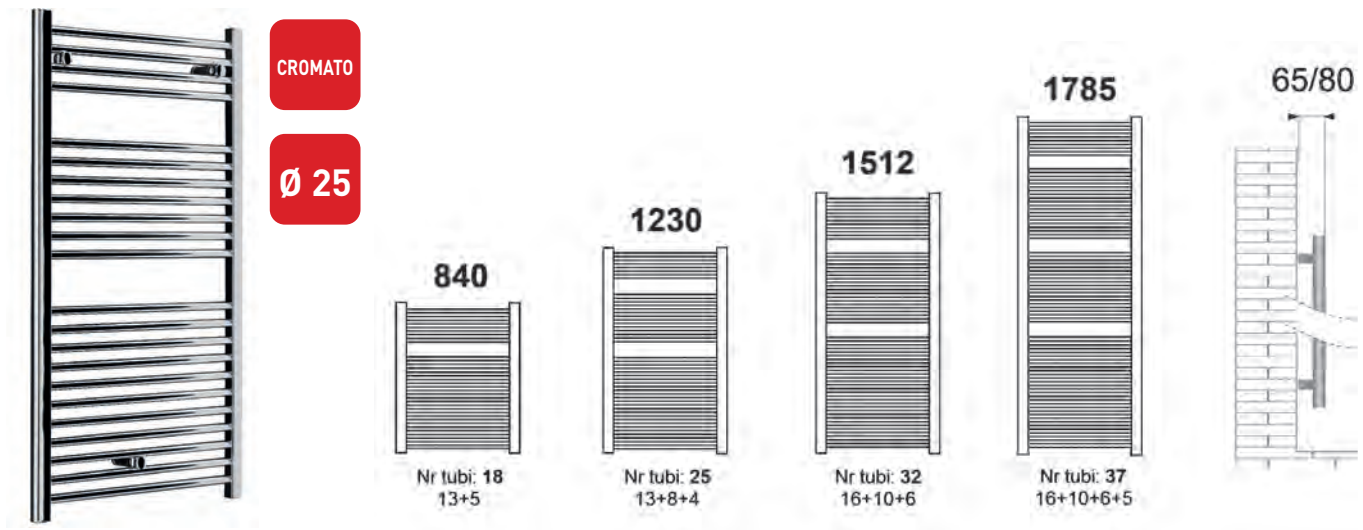

codice	altezza (mm)	larghezza (mm)	interasse (mm)	watt		peso (kg)	contenuto acqua (litri)	Resistenza (Watt)	UM	min. ord.	cat.	prezzo (€)
				Δt 30°C	Δt 50°C							
6111001	840	400	355	127	236	6,3	4,0	200	NR	1	15	210,20
6111002	840	450	405	143	265	6,9	4,4	300	NR	1	15	219,71
6111003	840	500	455	156	292	7,5	4,7	300	NR	1	15	232,99
6111004	840	550	505	170	319	8,0	5,1	300	NR	1	15	251,38
6111005	840	600	555	184	346	8,6	5,5	300	NR	1	15	263,37
6111006	1230	400	355	168	321	9,0	5,6	300	NR	1	15	285,49
6111007	1230	450	405	189	361	9,7	6,2	300	NR	1	15	299,44
6111008	1230	500	455	210	400	10,5	6,7	300	NR	1	15	317,16
6111009	1230	550	505	230	439	11,3	7,2	500	NR	1	15	336,18
6111010	1230	600	555	250	479	12,1	7,8	500	NR	1	15	355,16
6111013	1512	450	405	233	444	12,3	7,8	500	NR	1	15	358,97
6111014	1512	500	455	257	491	13,3	8,5	500	NR	1	15	384,32
6111015	1512	550	505	282	539	14,3	9,1	500	NR	1	15	406,45
6111016	1512	600	555	306	587	15,3	9,8	700	NR	1	15	431,16
6111018	1785	400	355	251	478	13,1	8,3	500	NR	1	15	388,06
6111019	1785	450	405	282	538	14,3	9,1	500	NR	1	15	406,45
6111020	1785	500	455	311	593	15,4	9,9	700	NR	1	15	434,31
6111021	1785	550	505	339	649	16,6	10,6	700	NR	1	15	461,54
6111022	1785	600	555	368	705	17,8	11,4	700	NR	1	15	489,40

TERMOARREDO

ACCESSORI RICAMBI TERMOARREDO

TERMOSTATO DIGITALE LED

NOVITÀ!



codice	sigla	colore	UM	min. ord. conf.	cat.	prezzo (€)
6191106	388595	bianco	NR	1	09	314,44
6191107	390669	nero opaco	NR	1	09	347,84
6191108	389505	cromato	NR	1	09	347,84

TERMOSTATO ANALOGICO



codice	sigla	colore	UM	min. ord. conf.	cat.	prezzo (€)
6191101	386005	bianco	NR	1	09	166,64
6191102	386006	cromato	NR	1	09	203,36

TELECOMANDO DIGITALE

Per termostato digitale led
6191106
6191107
6191108



NOVITÀ!

codice	sigla	colore	UM	min. ord. conf.	cat.	prezzo (€)
6191105	386011	bianco	NR	1	09	122,76

INTERRUTTORE ON-OFF



codice	sigla	colore	UM	min. ord. conf.	cat.	prezzo (€)
6191404	386007	bianco	NR	1	09	103,56
6191405	386008	cromato	NR	1	09	121,52

KIT DI FISSAGGIO



codice	sigla	modello - colore	UM	min. ord. conf.	cat.	prezzo (€)
6191409	389064	Cloe bianco	NR	1	09	20,88
6191411	390464	Cloe nero	NR	1	09	20,88
6191412	380550	Cloe cromato	NR	1	09	24,64
6191402	388111	Giada bianco	NR	1	09	26,60
6191413	380791	Giada nero	NR	1	09	20,88
6191406	388112	Giada cromato	NR	1	09	28,80

BLISTER ATTACCHI BANDIERA

Per modelli Cloe e Giada



codice	sigla	colore	UM	min. ord. conf.	cat.	prezzo (€)
6191201	385977	bianco	NR	1	09	180,40
6191202	385978	cromato	NR	1	09	278,12

APPENDINO SINGOLO



codice	sigla	colore	UM	min. ord. conf.	cat.	prezzo (€)
6190001	388132	bianco	NR	1	09	21,64
6190002	388133	cromato	NR	1	09	28,80

STENDINO



codice	sigla	colore - lunghezza	UM	min. ord. conf.	cat.	prezzo (€)
6190003	385023	bianco cm.40	NR	1	09	127,80
6190004	385024	bianco cm.50	NR	1	09	138,20
6190006	385026	cromo cm.40	NR	1	09	175,00

RACCORDO A TEE



codice	sigla	colore	UM	min. ord. conf.	cat.	prezzo (€)
6190009	386095	bianco	NR	1	09	35,08
6190010	386096	cromato	NR	1	09	35,08

RESISTENZA ELETTRICA SENZA INTERRUTTORE



codice	sigla	potenza	UM	min. ord. conf.	cat.	prezzo (€)
6191001	385987	300W	NR	1	09	157,44
6191002	385988	500W	NR	1	09	166,64
6191003	385989	700W	NR	1	09	177,92
6191004	385990	1000W	NR	1	09	210,04

RESISTENZA ELETTRICA PER TERMOSTATO



codice	sigla	potenza	UM	min. ord. conf.	cat.	prezzo (€)
6191009	385992	300W	NR	1	09	161,16
6191010	385993	500W	NR	1	09	161,16
6191011	385995	700W	NR	1	09	187,04
6191012	385996	1000W	NR	1	09	216,32

TANICA GLICOLE

Diluito al 10% circa
temperatura minima - 5°C



codice	sigla	descrizione	UM	min. ord. conf.	cat.	prezzo (€)
6191403	386093	5 litri	NR	1	09	82,92

RADIATORI IN ALLUMINIO

MODELLO ANTEPRIMA

350 - 500 - 530 - 600

IN ALLUMINIO ESTRUSO

modello	dimensioni in mm				Ø attacchi	potenza termica UNI EN 442 watt	
	A	B	C	D		Δt 30°C	Δt 50°C
	altezza tot.	lunghezza	profondità	interasse			
ANTEPRIMA 350	384	50	95	350	1/2"	24,1	48,0
ANTEPRIMA 500	534	50	95	500	1/2"	32,8	65,2
ANTEPRIMA 530	564	50	95	530	1/2"	34,5	68,6
ANTEPRIMA 600	634	50	95	600	1/2"	38,5	76,4
ANTEPRIMA 623	657	50	95	623	1/2"	39,8	79,0
ANTEPRIMA 700	734	50	95	700	1/2"	44,1	87,4
ANTEPRIMA 730	764	50	95	730	1/2"	45,8	90,7
ANTEPRIMA 800	834	50	95	800	1/2"	49,6	98,2
ANTEPRIMA 813	847	50	95	813	1/2"	50,4	99,6
ANTEPRIMA 900	934	50	95	900	1/2"	55,1	108,9

NOVITÀ!

BIANCO
RAL
9010



Accessori a corredo:

- n. 2 mensole fino a 8 elementi
 - n. 3 mensole da 10 a 24 elementi
 - n. 1 tappo destro D.1/2" bianco
 - n. 1 valvola sfogo manuale D.1/2" bianca
- Le griglie sono fornite dello stesso colore del radiatore

L'ordine del modello ANTEPRIMA deve sempre contenere le specifiche del collegamento idraulico (vedi schema a pag. 269)

serie	codice	sigla	numero elementi	watt Δt 50°C	UM	cat.	prezzo (€)	
ANTEPRIMA 350	6943506	AN03501006	6	288	NR	10	291,28	
	6943507	AN03501007	7	336	NR	10	339,16	
	6943508	AN03501008	8	384	NR	10	387,83	
	6943509	AN03501009	9	432	NR	10	436,52	
	6943510	AN03501010	10	480	NR	10	485,18	
	6943511	AN03501011	11	528	NR	10	533,06	
	6943512	AN03501012	12	576	NR	10	582,54	
	6943513	AN03501013	13	624	NR	10	630,42	
	6943514	AN03501014	14	672	NR	10	679,11	
	6943515	AN03501015	15	720	NR	10	727,78	
	6943516	AN03501016	16	768	NR	10	776,47	
	6943517	AN03501017	17	816	NR	10	825,13	
	6943518	AN03501018	18	864	NR	10	873,01	
	6943519	AN03501019	19	912	NR	10	921,70	
	6943520	AN03501020	20	960	NR	10	970,37	
	6943521	AN03501021	21	1008	NR	10	1.019,06	
	6943522	AN03501022	22	1056	NR	10	1.067,72	
	6943523	AN03501023	23	1104	NR	10	1.115,60	
	6943524	AN03501024	24	1152	NR	10	1.165,08	
	ANTEPRIMA 500	6945006	AN05001006	6	391	NR	10	340,76
		6945007	AN05001007	7	456	NR	10	397,40
		6945008	AN05001008	8	522	NR	10	454,86
		6945009	AN05001009	9	587	NR	10	511,53
		6945010	AN05001010	10	652	NR	10	568,18
6945011		AN05001011	11	717	NR	10	624,85	
6945012		AN05001012	12	782	NR	10	682,30	
6945013		AN05001013	13	848	NR	10	738,95	
6945014		AN05001014	14	913	NR	10	795,62	
6945015		AN05001015	15	978	NR	10	852,26	
6945016		AN05001016	16	1043	NR	10	909,72	
6945017		AN05001017	17	1108	NR	10	966,39	
6945018		AN05001018	18	1174	NR	10	1.023,04	
6945019		AN05001019	19	1239	NR	10	1.079,71	
6945020		AN05001020	20	1304	NR	10	1.137,16	
6945021		AN05001021	21	1369	NR	10	1.193,81	
6945022		AN05001022	22	1434	NR	10	1.250,48	
6945023		AN05001023	23	1500	NR	10	1.307,94	
6945024		AN05001024	24	1565	NR	10	1.364,58	

serie	codice	sigla	numero elementi	watt Δt 50°C	UM	cat.	prezzo (€)	
ANTEPRIMA 530	6945306	AN05301006	6	412	NR	10	355,12	
	6945307	AN05301007	7	480	NR	10	413,36	
	6945308	AN05301008	8	549	NR	10	473,23	
	6945309	AN05301009	9	617	NR	10	532,28	
	6945310	AN05301010	10	686	NR	10	591,33	
	6945311	AN05301011	11	755	NR	10	650,38	
	6945312	AN05301012	12	823	NR	10	709,44	
	6945313	AN05301013	13	892	NR	10	768,49	
	6945314	AN05301014	14	960	NR	10	827,54	
	6945315	AN05301015	15	1029	NR	10	887,38	
	6945316	AN05301016	16	1098	NR	10	945,64	
	6945317	AN05301017	17	1166	NR	10	1.005,48	
	6945318	AN05301018	18	1235	NR	10	1.064,53	
	6945319	AN05301019	19	1303	NR	10	1.123,58	
	6945320	AN05301020	20	1372	NR	10	1.182,64	
	6945321	AN05301021	21	1441	NR	10	1.241,69	
	6945322	AN05301022	22	1509	NR	10	1.300,74	
	6945323	AN05301023	23	1578	NR	10	1.359,79	
	6945324	AN05301024	24	1646	NR	10	1.418,84	
	ANTEPRIMA 600	6946006	AN06001006	6	458	NR	10	364,70
		6946007	AN06001007	7	535	NR	10	426,13
		6946008	AN06001008	8	611	NR	10	486,78
		6946009	AN06001009	9	688	NR	10	547,43
		6946010	AN06001010	10	764	NR	10	608,89
6946011		AN06001011	11	840	NR	10	669,54	
6946012		AN06001012	12	917	NR	10	730,18	
6946013		AN06001013	13	993	NR	10	790,83	
6946014		AN06001014	14	1070	NR	10	852,26	
6946015		AN06001015	15	1146	NR	10	912,91	
6946016		AN06001016	16	1222	NR	10	973,56	
6946017		AN06001017	17	1299	NR	10	1.034,21	
6946018		AN06001018	18	1375	NR	10	1.095,67	
6946019		AN06001019	19	1452	NR	10	1.156,32	
6946020		AN06001020	20	1528	NR	10	1.216,96	
6946021		AN06001021	21	1604	NR	10	1.277,61	
6946022		AN06001022	22	1681	NR	10	1.339,69	
6946023		AN06001023	23	1757	NR	10	1.418,84	
6946024		AN06001024	24	1834	NR	10	1.460,34	

623 - 700 - 730 - 800 - 813 - 900

serie	codice	sigla	numero elementi	watt Δt 50°C	UM	cat.	prezzo (€)	
ANTEPRIMA 623	6946206	AN06231006	6	474	NR	10	382,26	
	6946207	AN06231007	7	553	NR	10	445,28	
	6946208	AN06231008	8	632	NR	10	509,12	
	6946209	AN06231009	9	711	NR	10	572,96	
	6946210	AN06231010	10	790	NR	10	636,80	
	6946211	AN06231011	11	869	NR	10	700,64	
	6946212	AN06231012	12	948	NR	10	764,48	
	6946213	AN06231013	13	1027	NR	10	827,54	
	6946214	AN06231014	14	1106	NR	10	891,38	
	6946215	AN06231015	15	1185	NR	10	955,22	
	6946216	AN06231016	16	1264	NR	10	1.019,06	
	6946217	AN06231017	17	1343	NR	10	1.082,90	
	6946218	AN06231018	18	1422	NR	10	1.145,93	
	6946219	AN06231019	19	1501	NR	10	1.209,77	
	6946220	AN06231020	20	1580	NR	10	1.273,61	
	6946221	AN06231021	21	1659	NR	10	1.336,66	
	6946222	AN06231022	22	1738	NR	10	1.401,29	
	6946223	AN06231023	23	1817	NR	10	1.464,34	
	6946224	AN06231024	24	1896	NR	10	1.528,18	
	ANTEPRIMA 700	6947006	AN07001006	6	524	NR	10	400,60
		6947007	AN07001007	7	612	NR	10	466,84
		6947008	AN07001008	8	699	NR	10	533,88
		6947009	AN07001009	9	787	NR	10	600,10
		6947010	AN07001010	10	874	NR	10	667,13
6947011		AN07001011	11	961	NR	10	734,16	
6947012		AN07001012	12	1049	NR	10	800,41	
6947013		AN07001013	13	1136	NR	10	867,44	
6947014		AN07001014	14	1224	NR	10	933,66	
6947015		AN07001015	15	1311	NR	10	1.000,69	
6947016		AN07001016	16	1398	NR	10	1.067,72	
6947017		AN07001017	17	1486	NR	10	1.133,97	
6947018		AN07001018	18	1573	NR	10	1.201,00	
6947019		AN07001019	19	1661	NR	10	1.267,22	
6947020		AN07001020	20	1748	NR	10	1.334,26	
6947021		AN07001021	21	1835	NR	10	1.401,29	
6947022		AN07001022	22	1923	NR	10	1.467,54	
6947023		AN07001023	23	2010	NR	10	1.534,57	
6947024		AN07001024	24	2098	NR	10	1.600,79	
ANTEPRIMA 730		6947306	AN07301006	6	544	NR	10	409,39
		6947307	AN07301007	7	635	NR	10	477,20
		6947308	AN07301008	8	726	NR	10	545,83
		6947309	AN07301009	9	816	NR	10	614,46
		6947310	AN07301010	10	907	NR	10	682,30
	6947311	AN07301011	11	998	NR	10	750,12	
	6947312	AN07301012	12	1088	NR	10	818,75	
	6947313	AN07301013	13	1179	NR	10	887,38	
	6947314	AN07301014	14	1270	NR	10	955,22	
	6947315	AN07301015	15	1361	NR	10	1.023,04	
	6947316	AN07301016	16	1451	NR	10	1.091,66	
	6947317	AN07301017	17	1542	NR	10	1.160,29	
	6947318	AN07301018	18	1633	NR	10	1.228,14	
	6947319	AN07301019	19	1723	NR	10	1.296,76	
	6947320	AN07301020	20	1814	NR	10	1.364,58	
	6947321	AN07301021	21	1905	NR	10	1.432,42	
	6947322	AN07301022	22	1995	NR	10	1.501,05	
	6947323	AN07301023	23	2086	NR	10	1.568,87	
	6947324	AN07301024	24	2177	NR	10	1.637,50	

serie	codice	sigla	numero elementi	watt Δt 50°C	UM	cat.	prezzo (€)	
ANTEPRIMA 800	6948006	AN08001006	6	859	NR	10	422,94	
	6948007	AN08001007	7	687	NR	10	493,16	
	6948008	AN08001008	8	786	NR	10	564,20	
	6948009	AN08001009	9	884	NR	10	634,42	
	6948010	AN08001010	10	982	NR	10	704,65	
	6948011	AN08001011	11	1080	NR	10	775,66	
	6948012	AN08001012	12	1178	NR	10	845,88	
	6948013	AN08001013	13	1277	NR	10	916,10	
	6948014	AN08001014	14	1375	NR	10	987,14	
	6948015	AN08001015	15	1473	NR	10	1.057,36	
	6948016	AN08001016	16	1571	NR	10	1.128,37	
	6948017	AN08001017	17	1669	NR	10	1.198,60	
	6948018	AN08001018	18	1768	NR	10	1.268,82	
	6948019	AN08001019	19	1866	NR	10	1.339,04	
	6948020	AN08001020	20	1964	NR	10	1.410,08	
	6948021	AN08001021	21	2062	NR	10	1.480,30	
	6948022	AN08001022	22	2160	NR	10	1.551,31	
	6948023	AN08001023	23	2259	NR	10	1.621,54	
	6948024	AN08001024	24	2357	NR	10	1.691,76	
	ANTEPRIMA 813	6948106	AN08131006	6	598	NR	10	441,31
		6948107	AN08131007	7	697	NR	10	514,72
		6948108	AN08131008	8	797	NR	10	588,14
		6948109	AN08131009	9	896	NR	10	661,56
		6948110	AN08131010	10	996	NR	10	734,97
6948111		AN08131011	11	1096	NR	10	809,17	
6948112		AN08131012	12	1195	NR	10	881,80	
6948113		AN08131013	13	1295	NR	10	956,00	
6948114		AN08131014	14	1394	NR	10	1.029,42	
6948115		AN08131015	15	1494	NR	10	1.102,84	
6948116		AN08131016	16	1594	NR	10	1.176,25	
6948117		AN08131017	17	1693	NR	10	1.249,67	
6948118		AN08131018	18	1793	NR	10	1.323,08	
6948119		AN08131019	19	1892	NR	10	1.396,50	
6948120		AN08131020	20	1992	NR	10	1.470,73	
6948121		AN08131021	21	2092	NR	10	1.544,14	
6948122		AN08131022	22	2191	NR	10	1.617,56	
6948123		AN08131023	23	2291	NR	10	1.691,76	
6948124		AN08131024	24	2390	NR	10	1.765,18	
ANTEPRIMA 900		6949004	AN09001004	4	436	NR	10	318,42
		6949005	AN09001005	5	545	NR	10	398,22
		6949006	AN09001006	6	653	NR	10	478,02
		6949007	AN09001007	7	762	NR	10	557,00
		6949008	AN09001008	8	871	NR	10	636,80
	6949009	AN09001009	9	980	NR	10	716,60	
	6949010	AN09001010	10	1089	NR	10	796,40	
	6949011	AN09001011	11	1198	NR	10	875,42	
	6949012	AN09001012	12	1307	NR	10	955,22	
	6949013	AN09001013	13	1416	NR	10	1.035,02	
	6949014	AN09001014	14	1525	NR	10	1.114,82	
	6949015	AN09001015	15	1634	NR	10	1.193,81	
	6949016	AN09001016	16	1742	NR	10	1.273,61	
	6949017	AN09001017	17	1851	NR	10	1.353,41	
	6949018	AN09001018	18	1960	NR	10	1.432,42	
	6949019	AN09001019	19	2069	NR	10	1.512,22	
	6949020	AN09001020	20	2178	NR	10	1.592,02	
	6949021	AN09001021	21	2287	NR	10	1.671,82	
	6949022	AN09001022	22	2396	NR	10	1.750,81	
	6949023	AN09001023	23	2505	NR	10	1.830,61	
	6949024	AN09001024	24	2614	NR	10	1.910,41	

RADIATORI IN ALLUMINIO

MODELLO ANTEPRIMA

1000 - 1200 - 1400 - 1600

IN ALLUMINIO ESTRUSO

modello	dimensioni in mm				Ø attacchi	potenza termica UNI EN 442 watt	
	A	B	C	D		Δt 30°C	Δt 50°C
	altezza tot.	lunghezza	profondità	interasse			
ANTEPRIMA 1000	1034	50	95	1000	1/2"	60,1	119,4
ANTEPRIMA 1200	1234	50	95	1200	1/2"	69,7	139,9
ANTEPRIMA 1400	1434	50	95	1400	1/2"	78,8	160,0
ANTEPRIMA 1600	1634	50	95	1600	1/2"	88,7	179,5
ANTEPRIMA 1735	1769	50	95	1735	1/2"	95,2	192,4
ANTEPRIMA 1800	1834	50	95	1800	1/2"	98,3	198,5
ANTEPRIMA 2000	2034	50	95	2000	1/2"	107,8	217,1

NOVITÀ!

BIANCO
RAL
9010



Accessori a corredo:

- n. 2 mensole fino a 8 elementi
 - n. 3 mensole da 10 a 24 elementi
 - n. 1 tappo destro D.1/2" bianco
 - n. 1 valvola sfogo manuale D.1/2" bianca
- Le griglie sono fornite dello stesso colore del radiatore

L'ordine del modello ANTEPRIMA deve sempre contenere le specifiche del collegamento idraulico (vedi schema a pag. 269)

serie	codice	sigla	numero elementi	watt Δt 50°C	UM	cat.	prezzo (€)
ANTEPRIMA 1000	6941004	AN10001004	4	478	NR	10	348,74
	6941005	AN10001005	5	597	NR	10	435,71
	6941006	AN10001006	6	716	NR	10	522,70
	6941007	AN10001007	7	836	NR	10	610,48
	6941008	AN10001008	8	955	NR	10	697,45
	6941009	AN10001009	9	1075	NR	10	784,45
	6941010	AN10001010	10	1194	NR	10	871,42
	6941011	AN10001011	11	1313	NR	10	959,20
	6941012	AN10001012	12	1433	NR	10	1.046,19
	6941013	AN10001013	13	1552	NR	10	1.133,16
	6941014	AN10001014	14	1672	NR	10	1.220,94
	6941015	AN10001015	15	1791	NR	10	1.307,12
	6941016	AN10001016	16	1910	NR	10	1.394,90
	6941017	AN10001017	17	2030	NR	10	1.481,90
	6941018	AN10001018	18	2149	NR	10	1.568,87
	6941019	AN10001019	19	2269	NR	10	1.656,65
	6941020	AN10001020	20	2388	NR	10	1.743,64
	6941021	AN10001021	21	2507	NR	10	1.830,61
	6941022	AN10001022	22	2627	NR	10	1.917,61
	6941023	AN10001023	23	2746	NR	10	2.005,39
	6941024	AN10001024	24	2866	NR	10	2.092,36
	6941204	AN12001004	4	560	NR	10	394,21
	6941205	AN12001005	5	700	NR	10	492,38
	6941206	AN12001006	6	839	NR	10	591,33
6941207	AN12001007	7	979	NR	10	689,47	
6941208	AN12001008	8	1119	NR	10	796,40	
6941209	AN12001009	9	1259	NR	10	887,38	
6941210	AN12001010	10	1399	NR	10	985,54	
6941211	AN12001011	11	1539	NR	10	1.083,68	
6941212	AN12001012	12	1679	NR	10	1.182,64	
6941213	AN12001013	13	1819	NR	10	1.280,80	
6941214	AN12001014	14	1959	NR	10	1.379,76	
6941215	AN12001015	15	2099	NR	10	1.477,90	
6941216	AN12001016	16	2238	NR	10	1.576,85	

serie	codice	sigla	numero elementi	watt Δt 50°C	UM	cat.	prezzo (€)
ANTEPRIMA 1400	6941404	AN14001004	4	640	NR	10	436,52
	6941405	AN14001005	5	800	NR	10	545,83
	6941406	AN14001006	6	960	NR	10	654,36
	6941407	AN14001007	7	1120	NR	10	764,48
	6941408	AN14001008	8	1280	NR	10	873,01
	6941409	AN14001009	9	1440	NR	10	981,54
	6941410	AN14001010	10	1600	NR	10	1.091,66
	6941411	AN14001011	11	1760	NR	10	1.201,00
	6941412	AN14001012	12	1920	NR	10	1.310,32
	6941413	AN14001013	13	2080	NR	10	1.418,84
	6941414	AN14001014	14	2240	NR	10	1.528,18
	6941415	AN14001015	15	2400	NR	10	1.637,50
	6941416	AN14001016	16	2560	NR	10	1.746,02
	6941604	AN16001004	4	718	NR	10	474,82
	6941605	AN16001005	5	898	NR	10	593,71
	6941606	AN16001006	6	1077	NR	10	712,63
6941607	AN16001007	7	1257	NR	10	831,52	
6941608	AN16001008	8	1436	NR	10	949,62	
6941609	AN16001009	9	1616	NR	10	1.068,54	
6941610	AN16001010	10	1795	NR	10	1.187,42	
6941611	AN16001011	11	1975	NR	10	1.306,34	
6941612	AN16001012	12	2154	NR	10	1.425,23	
6941613	AN16001013	13	2334	NR	10	1.543,33	
6941614	AN16001014	14	2513	NR	10	1.662,25	
6941615	AN16001015	15	2693	NR	10	1.781,14	
6941616	AN16001016	16	2872	NR	10	1.899,24	

1735 - 1800 - 2000

serie	codice	sigla	numero elementi	watt Δt 50°C	UM	cat.	prezzo (€)	
ANTEPRIMA 1735	6941704	AN17351004	4	770	NR	10	521,89	
	6941705	AN17351005	5	962	NR	10	651,98	
	6941706	AN17351006	6	1154	NR	10	782,04	
	6941707	AN17351007	7	1347	NR	10	912,91	
	6941708	AN17351008	8	1539	NR	10	1.043,00	
	6941709	AN17351009	9	1732	NR	10	1.173,06	
	6941710	AN17351010	10	1924	NR	10	1.303,93	
	6941711	AN17351011	11	2116	NR	10	1.434,02	
	6941712	AN17351012	12	2309	NR	10	1.564,08	
	6941713	AN17351013	13	2501	NR	10	1.694,95	
	6941714	AN17351014	14	2694	NR	10	1.825,82	
	6941715	AN17351015	15	2886	NR	10	1.955,10	
	6941716	AN17351016	16	3078	NR	10	2.085,97	
	ANTEPRIMA 1800	6941804	AN18001004	4	794	NR	10	534,66
		6941805	AN18001005	5	993	NR	10	667,94
		6941806	AN18001006	6	1191	NR	10	801,19
6941807		AN18001007	7	1390	NR	10	935,26	
6941808		AN18001008	8	1588	NR	10	1.068,54	
6941809		AN18001009	9	1787	NR	10	1.202,60	
6941810		AN18001010	10	1985	NR	10	1.335,85	
6941811		AN18001011	11	2184	NR	10	1.469,13	
6941812		AN18001012	12	2382	NR	10	1.603,20	
6941813		AN18001013	13	2581	NR	10	1.736,45	
6941814	AN18001014	14	2779	NR	10	1.870,51		
6941815	AN18001015	15	2978	NR	10	2.003,79		
6941816	AN18001016	16	3176	NR	10	2.137,04		

serie	codice	sigla	numero elementi	watt Δt 50°C	UM	cat.	prezzo (€)
ANTEPRIMA 2000	6942004	AN20001004	4	868	NR	10	564,20
	6942005	AN20001005	5	1086	NR	10	704,65
	6942006	AN20001006	6	1303	NR	10	845,88
	6942007	AN20001007	7	1520	NR	10	987,14
	6942008	AN20001008	8	1737	NR	10	1.128,37
	6942009	AN20001009	9	1954	NR	10	1.268,82
	6942010	AN20001010	10	2171	NR	10	1.410,08
	6942011	AN20001011	11	2388	NR	10	1.551,31
	6942012	AN20001012	12	2605	NR	10	1.691,76
	6942013	AN20001013	13	2822	NR	10	1.833,02
	6942014	AN20001014	14	3039	NR	10	1.974,25
	6942015	AN20001015	15	3257	NR	10	2.114,70
	6942016	AN20001016	16	3474	NR	10	2.255,96

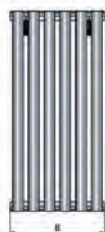

Nei posti dei radiatori si ottiene la resa termica prevista osservando le distanze di seguito precisate:
 ≈ 19 - 24 mm dalla parete
 ≥ 100 mm dal pavimento
 ≥ 100 mm dalla mensola o sottofinestra

Per evitare che le dilatazioni termiche dell'impianto provochino rumorosità in corrispondenza dei corpi scaldanti si consiglia di posizionare le mensole al centro dell'apposito spazio.

RADIATORI IN ALLUMINIO

MODELLO TONALE

350 - 500 - 530 - 600

IN ALLUMINIO ESTRUSO

modello	dimensioni in mm				Ø attacchi	potenza termica UNI EN 442 watt	
	A	B	C	D		Δt 30°C	Δt 50°C
	altezza tot.	lunghezza	profondità	interasse			
TONALE 350	384	50	95	350	1/2"	24,6	49,4
TONALE 500	534	50	95	500	1/2"	33,6	67,4
TONALE 530	564	50	95	530	1/2"	35,4	70,9
TONALE 600	634	50	95	600	1/2"	39,5	79,0
TONALE 623	657	50	95	623	1/2"	40,8	81,7
TONALE 700	734	50	95	700	1/2"	45,3	90,5
TONALE 730	764	50	95	730	1/2"	47,0	93,9
TONALE 800	834	50	95	800	1/2"	50,9	101,7
TONALE 813	847	50	95	813	1/2"	51,7	103,1
TONALE 900	934	50	95	900	1/2"	56,5	112,7

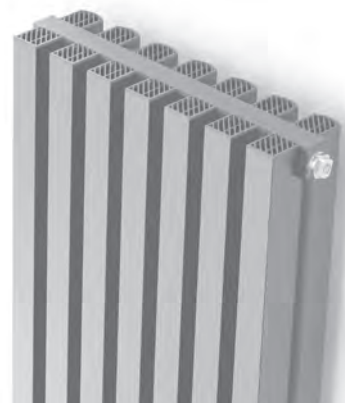

**BIANCO
RAL
9010**

Accessori a corredo:

- n. 2 mensole fino a 8 elementi
 - n. 3 mensole da 10 a 24 elementi
 - n. 1 tappo destro D.1/2" bianco
 - n. 1 valvola sfogo manuale D.1/2" bianca
- Le griglie sono fornite dello stesso colore del radiatore

L'ordine del modello TONALE deve sempre contenere le seguenti specifiche:

- collegamento idraulico
 - configurazione fronte elementi
- (vedi schema a pag. 269)

serie	codice	sigla	numero elementi	watt Δt 50°C	UM	cat.	prezzo (€)	
TONALE 350	6935006	T003501006	6	296	NR	10	291,28	
	6935007	T003501007	7	346	NR	10	339,16	
	6935008	T003501008	8	395	NR	10	387,83	
	6935009	T003501009	9	445	NR	10	436,52	
	6935010	T003501010	10	494	NR	10	485,18	
	6935011	T003501011	11	543	NR	10	533,06	
	6935012	T003501012	12	593	NR	10	582,54	
	6935013	T003501013	13	642	NR	10	630,42	
	6935014	T003501014	14	692	NR	10	679,11	
	6935015	T003501015	15	741	NR	10	727,78	
	6935016	T003501016	16	790	NR	10	776,47	
	6935017	T003501017	17	840	NR	10	825,13	
	6935018	T003501018	18	889	NR	10	873,01	
	6935019	T003501019	19	939	NR	10	921,70	
	6935020	T003501020	20	988	NR	10	970,37	
	6935021	T003501021	21	1037	NR	10	1.019,06	
	6935022	T003501022	22	1087	NR	10	1.067,72	
	6935023	T003501023	23	1136	NR	10	1.115,60	
	6935024	T003501024	24	1186	NR	10	1.165,08	
	TONALE 500	6950006	T005001006	6	404	NR	10	340,76
		6950007	T005001007	7	472	NR	10	397,40
		6950008	T005001008	8	539	NR	10	454,86
		6950009	T005001009	9	607	NR	10	511,53
		6950010	T005001010	10	674	NR	10	568,18
6950011		T005001011	11	741	NR	10	624,85	
6950012		T005001012	12	809	NR	10	682,30	
6950013		T005001013	13	876	NR	10	738,95	
6950014		T005001014	14	944	NR	10	795,62	
6950015		T005001015	15	1011	NR	10	852,26	
6950016		T005001016	16	1078	NR	10	909,72	
6950017		T005001017	17	1146	NR	10	966,39	
6950018		T005001018	18	1213	NR	10	1.023,04	
6950019		T005001019	19	1281	NR	10	1.079,71	
6950020		T005001020	20	1348	NR	10	1.137,16	
6950021		T005001021	21	1415	NR	10	1.193,81	
6950022		T005001022	22	1483	NR	10	1.250,48	
6950023		T005001023	23	1550	NR	10	1.307,94	
6950024		T005001024	24	1618	NR	10	1.364,58	

serie	codice	sigla	numero elementi	watt Δt 50°C	UM	cat.	prezzo (€)	
TONALE 530	6953006	T005301006	6	425	NR	10	355,12	
	6953007	T005301007	7	496	NR	10	413,36	
	6953008	T005301008	8	567	NR	10	473,23	
	6953009	T005301009	9	638	NR	10	532,28	
	6953010	T005301010	10	709	NR	10	591,33	
	6953011	T005301011	11	780	NR	10	650,38	
	6953012	T005301012	12	851	NR	10	709,44	
	6953013	T005301013	13	922	NR	10	768,49	
	6953014	T005301014	14	993	NR	10	827,54	
	6953015	T005301015	15	1064	NR	10	887,38	
	6953016	T005301016	16	1134	NR	10	945,64	
	6953017	T005301017	17	1205	NR	10	1.005,48	
	6953018	T005301018	18	1276	NR	10	1.064,53	
	6953019	T005301019	19	1347	NR	10	1.123,58	
	6953020	T005301020	20	1418	NR	10	1.182,64	
	6953021	T005301021	21	1489	NR	10	1.241,69	
	6953022	T005301022	22	1560	NR	10	1.300,74	
	6953023	T005301023	23	1631	NR	10	1.359,79	
	6953024	T005301024	24	1702	NR	10	1.418,84	
	TONALE 600	6960006	T006001006	6	474	NR	10	364,70
		6960007	T006001007	7	553	NR	10	426,13
		6960008	T006001008	8	632	NR	10	486,78
		6960009	T006001009	9	711	NR	10	547,43
		6960010	T006001010	10	790	NR	10	608,89
6960011		T006001011	11	869	NR	10	669,54	
6960012		T006001012	12	948	NR	10	730,18	
6960013		T006001013	13	1027	NR	10	790,83	
6960014		T006001014	14	1106	NR	10	852,26	
6960015		T006001015	15	1185	NR	10	912,91	
6960016		T006001016	16	1264	NR	10	973,56	
6960017		T006001017	17	1343	NR	10	1.034,21	
6960018		T006001018	18	1422	NR	10	1.095,67	
6960019		T006001019	19	1501	NR	10	1.156,32	
6960020		T006001020	20	1580	NR	10	1.216,96	
6960021		T006001021	21	1659	NR	10	1.277,61	
6960022		T006001022	22	1738	NR	10	1.339,69	
6960023		T006001023	23	1817	NR	10	1.418,84	
6960024		T006001024	24	1896	NR	10	1.460,34	

623 - 700 - 730 - 800 - 813 - 900

serie	codice	sigla	numero elementi	watt Δt 50°C	UM	cat.	prezzo (€)	
TONALE 623	6962306	T006231006	6	490	NR	10	382,26	
	6962307	T006231007	7	572	NR	10	445,28	
	6962308	T006231008	8	654	NR	10	509,12	
	6962309	T006231009	9	735	NR	10	572,96	
	6962310	T006231010	10	817	NR	10	636,80	
	6962311	T006231011	11	899	NR	10	700,64	
	6962312	T006231012	12	980	NR	10	764,48	
	6962313	T006231013	13	1062	NR	10	827,54	
	6962314	T006231014	14	1144	NR	10	891,38	
	6962315	T006231015	15	1226	NR	10	955,22	
	6962316	T006231016	16	1307	NR	10	1.019,06	
	6962317	T006231017	17	1389	NR	10	1.082,90	
	6962318	T006231018	18	1471	NR	10	1.145,93	
	6962319	T006231019	19	1552	NR	10	1.209,77	
	6962320	T006231020	20	1634	NR	10	1.273,61	
	6962321	T006231021	21	1716	NR	10	1.336,66	
	6962322	T006231022	22	1797	NR	10	1.401,29	
	6962323	T006231023	23	1879	NR	10	1.464,34	
	6962324	T006231024	24	1961	NR	10	1.528,18	
	TONALE 700	6970006	T007001006	6	543	NR	10	400,60
		6970007	T007001007	7	634	NR	10	466,84
		6970008	T007001008	8	724	NR	10	533,88
		6970009	T007001009	9	815	NR	10	600,10
		6970010	T007001010	10	905	NR	10	667,13
6970011		T007001011	11	996	NR	10	734,16	
6970012		T007001012	12	1086	NR	10	800,41	
6970013		T007001013	13	1177	NR	10	867,44	
6970014		T007001014	14	1267	NR	10	933,66	
6970015		T007001015	15	1358	NR	10	1.000,69	
6970016		T007001016	16	1448	NR	10	1.067,72	
6970017		T007001017	17	1539	NR	10	1.133,97	
6970018		T007001018	18	1629	NR	10	1.201,00	
6970019		T007001019	19	1720	NR	10	1.267,22	
6970020		T007001020	20	1810	NR	10	1.334,26	
6970021		T007001021	21	1901	NR	10	1.401,29	
6970022		T007001022	22	1991	NR	10	1.467,54	
6970023		T007001023	23	2082	NR	10	1.534,57	
6970024		T007001024	24	2172	NR	10	1.600,79	
TONALE 730		6973006	T007301006	6	563	NR	10	409,39
		6973007	T007301007	7	657	NR	10	477,20
		6973008	T007301008	8	751	NR	10	545,83
		6973009	T007301009	9	845	NR	10	614,46
		6973010	T007301010	10	939	NR	10	682,30
	6973011	T007301011	11	1033	NR	10	750,12	
	6973012	T007301012	12	1127	NR	10	818,75	
	6973013	T007301013	13	1221	NR	10	887,38	
	6973014	T007301014	14	1315	NR	10	955,22	
	6973015	T007301015	15	1409	NR	10	1.023,04	
	6973016	T007301016	16	1502	NR	10	1.091,66	
	6973017	T007301017	17	1596	NR	10	1.160,29	
	6973018	T007301018	18	1690	NR	10	1.228,14	
	6973019	T007301019	19	1784	NR	10	1.296,76	
	6973020	T007301020	20	1878	NR	10	1.364,58	
	6973021	T007301021	21	1972	NR	10	1.432,42	
	6973022	T007301022	22	2066	NR	10	1.501,05	
	6973023	T007301023	23	2160	NR	10	1.568,87	
	6973024	T007301024	24	2254	NR	10	1.637,50	

serie	codice	sigla	numero elementi	watt Δt 50°C	UM	cat.	prezzo (€)	
TONALE 800	6980006	T008001006	6	610	NR	10	422,94	
	6980007	T008001007	7	712	NR	10	493,16	
	6980008	T008001008	8	814	NR	10	564,20	
	6980009	T008001009	9	915	NR	10	634,42	
	6980010	T008001010	10	1017	NR	10	704,65	
	6980011	T008001011	11	1119	NR	10	775,66	
	6980012	T008001012	12	1220	NR	10	845,88	
	6980013	T008001013	13	1322	NR	10	916,10	
	6980014	T008001014	14	1424	NR	10	987,14	
	6980015	T008001015	15	1526	NR	10	1.057,36	
	6980016	T008001016	16	1627	NR	10	1.128,37	
	6980017	T008001017	17	1729	NR	10	1.198,60	
	6980018	T008001018	18	1831	NR	10	1.268,82	
	6980019	T008001019	19	1932	NR	10	1.339,04	
	6980020	T008001020	20	2034	NR	10	1.410,08	
	6980021	T008001021	21	2136	NR	10	1.480,30	
	6980022	T008001022	22	2237	NR	10	1.551,31	
	6980023	T008001023	23	2339	NR	10	1.621,54	
	6980024	T008001024	24	2441	NR	10	1.691,76	
	TONALE 813	6981306	T008131006	6	619	NR	10	441,31
		6981307	T008131007	7	722	NR	10	514,72
		6981308	T008131008	8	825	NR	10	588,14
		6981309	T008131009	9	928	NR	10	661,56
		6981310	T008131010	10	1031	NR	10	734,97
6981311		T008131011	11	1134	NR	10	809,17	
6981312		T008131012	12	1237	NR	10	881,80	
6981313		T008131013	13	1340	NR	10	956,00	
6981314		T008131014	14	1443	NR	10	1.029,42	
6981315		T008131015	15	1547	NR	10	1.102,84	
6981316		T008131016	16	1650	NR	10	1.176,25	
6981317		T008131017	17	1753	NR	10	1.249,67	
6981318		T008131018	18	1856	NR	10	1.323,08	
6981319		T008131019	19	1959	NR	10	1.396,50	
6981320		T008131020	20	2062	NR	10	1.470,73	
6981321		T008131021	21	2165	NR	10	1.544,14	
6981322		T008131022	22	2268	NR	10	1.617,56	
6981323		T008131023	23	2371	NR	10	1.691,76	
6981324		T008131024	24	2474	NR	10	1.765,18	
TONALE 900		6990004	T009001004	4	451	NR	10	318,42
		6990005	T009001005	5	564	NR	10	398,22
		6990006	T009001006	6	676	NR	10	478,02
		6990007	T009001007	7	789	NR	10	557,00
		6990008	T009001008	8	902	NR	10	636,80
	6990009	T009001009	9	1014	NR	10	716,60	
	6990010	T009001010	10	1127	NR	10	796,40	
	6990011	T009001011	11	1240	NR	10	875,42	
	6990012	T009001012	12	1352	NR	10	955,22	
	6990013	T009001013	13	1465	NR	10	1.035,02	
	6990014	T009001014	14	1578	NR	10	1.114,82	
	6990015	T009001015	15	1691	NR	10	1.193,81	
	6990016	T009001016	16	1803	NR	10	1.273,61	
	6990017	T009001017	17	1916	NR	10	1.353,41	
	6990018	T009001018	18	2029	NR	10	1.432,42	
	6990019	T009001019	19	2141	NR	10	1.512,22	
	6990020	T009001020	20	2254	NR	10	1.592,02	
	6990021	T009001021	21	2367	NR	10	1.671,82	
	6990022	T009001022	22	2479	NR	10	1.750,81	
	6990023	T009001023	23	2592	NR	10	1.830,61	
	6990024	T009001024	24	2705	NR	10	1.910,41	

RADIATORI IN ALLUMINIO

MODELLO TONALE

1000 - 1200 - 1400 - 1600

IN ALLUMINIO ESTRUSO

modello	dimensioni in mm				Ø attacchi	potenza termica UNI EN 442 watt	
	A	B	C	D		Δt 30°C	Δt 50°C
	altezza tot.	lunghezza	profondità	interasse			
TONALE 1000	1034	50	95	1000	1/2"	61,6	123,5
TONALE 1200	1234	50	95	1200	1/2"	71,5	144,6
TONALE 1400	1434	50	95	1400	1/2"	80,7	165,0
TONALE 1600	1634	50	95	1600	1/2"	90,6	184,6
TONALE 1735	1769	50	95	1735	1/2"	97,0	197,5
TONALE 1800	1834	50	95	1800	1/2"	100,1	203,6
TONALE 2000	2034	50	95	2000	1/2"	109,4	222,0

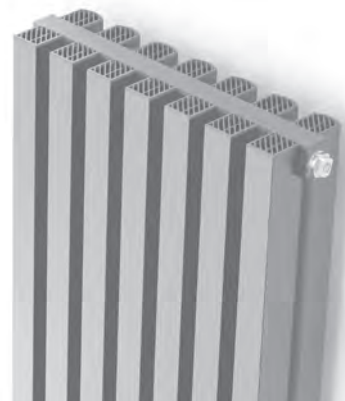

**BIANCO
RAL
9010**

Accessori a corredo:

- n. 2 mensole fino a 8 elementi
 - n. 3 mensole da 10 a 24 elementi
 - n. 1 tappo destro D.1/2" bianco
 - n. 1 valvola sfogo manuale D.1/2" bianca
- Le griglie sono fornite dello stesso colore del radiatore

L'ordine del modello TONALE deve sempre contenere le seguenti specifiche:

- collegamento idraulico
 - configurazione fronte elementi
- (vedi schema a pag. 269)

serie	codice	sigla	numero elementi	watt Δt 50°C	UM	cat.	prezzo (€)	
TONALE 1000	6910004	TO10001004	4	494	NR	10	348,74	
	6910005	TO10001005	5	618	NR	10	435,71	
	6910006	TO10001006	6	741	NR	10	522,70	
	6910007	TO10001007	7	865	NR	10	610,48	
	6910008	TO10001008	8	988	NR	10	697,45	
	6910009	TO10001009	9	1112	NR	10	784,45	
	6910010	TO10001010	10	1235	NR	10	871,42	
	6910011	TO10001011	11	1359	NR	10	959,20	
	6910012	TO10001012	12	1482	NR	10	1.046,19	
	6910013	TO10001013	13	1606	NR	10	1.133,16	
	6910014	TO10001014	14	1729	NR	10	1.220,94	
	6910015	TO10001015	15	1853	NR	10	1.307,12	
	6910016	TO10001016	16	1976	NR	10	1.394,90	
	6910017	TO10001017	17	2100	NR	10	1.481,90	
	6910018	TO10001018	18	2223	NR	10	1.568,87	
	6910019	TO10001019	19	2347	NR	10	1.656,65	
	6910020	TO10001020	20	2470	NR	10	1.743,64	
	6910021	TO10001021	21	2594	NR	10	1.830,61	
	6910022	TO10001022	22	2717	NR	10	1.917,61	
	6910023	TO10001023	23	2841	NR	10	2.005,39	
	6910024	TO10001024	24	2964	NR	10	2.092,36	
	TONALE 1200	6912004	TO12001004	4	578	NR	10	394,21
		6912005	TO12001005	5	723	NR	10	492,38
		6912006	TO12001006	6	868	NR	10	591,33
6912007		TO12001007	7	1012	NR	10	689,47	
6912008		TO12001008	8	1157	NR	10	796,40	
6912009		TO12001009	9	1301	NR	10	887,38	
6912010		TO12001010	10	1446	NR	10	985,54	
6912011		TO12001011	11	1591	NR	10	1.083,68	
6912012		TO12001012	12	1735	NR	10	1.182,64	
6912013		TO12001013	13	1880	NR	10	1.280,80	
6912014		TO12001014	14	2024	NR	10	1.379,76	
6912015		TO12001015	15	2169	NR	10	1.477,90	
6912016		TO12001016	16	2314	NR	10	1.576,85	

serie	codice	sigla	numero elementi	watt Δt 50°C	UM	cat.	prezzo (€)	
TONALE 1400	6914004	TO14001004	4	660	NR	10	436,52	
	6914005	TO14001005	5	825	NR	10	545,83	
	6914006	TO14001006	6	990	NR	10	654,36	
	6914007	TO14001007	7	1155	NR	10	764,48	
	6914008	TO14001008	8	1320	NR	10	873,01	
	6914009	TO14001009	9	1485	NR	10	981,54	
	6914010	TO14001010	10	1650	NR	10	1.091,66	
	6914011	TO14001011	11	1815	NR	10	1.201,00	
	6914012	TO14001012	12	1980	NR	10	1.310,32	
	6914013	TO14001013	13	2145	NR	10	1.418,84	
	6914014	TO14001014	14	2310	NR	10	1.528,18	
	6914015	TO14001015	15	2475	NR	10	1.637,50	
	6914016	TO14001016	16	2640	NR	10	1.746,02	
	TONALE 1600	6916004	TO16001004	4	738	NR	10	474,82
		6916005	TO16001005	5	923	NR	10	593,71
		6916006	TO16001006	6	1108	NR	10	712,63
6916007		TO16001007	7	1292	NR	10	831,52	
6916008		TO16001008	8	1477	NR	10	949,62	
6916009		TO16001009	9	1661	NR	10	1.068,54	
6916010		TO16001010	10	1846	NR	10	1.187,42	
6916011		TO16001011	11	2031	NR	10	1.306,34	
6916012		TO16001012	12	2215	NR	10	1.425,23	
6916013		TO16001013	13	2400	NR	10	1.543,33	
6916014	TO16001014	14	2584	NR	10	1.662,25		
6916015	TO16001015	15	2769	NR	10	1.781,14		
6916016	TO16001016	16	2954	NR	10	1.899,24		

1735 - 1800 - 2000

serie	codice	sigla	numero elementi	watt Δt 50°C	UM	cat.	prezzo (€)	
TONALE 1735	6917304	TO17351004	4	790	NR	10	521,89	
	6917305	TO17351005	5	988	NR	10	651,98	
	6917306	TO17351006	6	1185	NR	10	782,04	
	6917307	TO17351007	7	1383	NR	10	912,91	
	6917308	TO17351008	8	1580	NR	10	1.043,00	
	6917309	TO17351009	9	1778	NR	10	1.173,06	
	6917310	TO17351010	10	1975	NR	10	1.303,93	
	6917311	TO17351011	11	2173	NR	10	1.434,02	
	6917312	TO17351012	12	2370	NR	10	1.564,08	
	6917313	TO17351013	13	2568	NR	10	1.694,95	
	6917314	TO17351014	14	2765	NR	10	1.825,82	
	6917315	TO17351015	15	2963	NR	10	1.955,10	
	6917316	TO17351016	16	3160	NR	10	2.085,97	
	TONALE 1800	6918004	TO18001004	4	814	NR	10	534,66
		6918005	TO18001005	5	1018	NR	10	667,94
		6918006	TO18001006	6	1222	NR	10	801,19
6918007		TO18001007	7	1425	NR	10	935,26	
6918008		TO18001008	8	1629	NR	10	1.068,54	
6918009		TO18001009	9	1832	NR	10	1.202,60	
6918010		TO18001010	10	2036	NR	10	1.335,85	
6918011		TO18001011	11	2240	NR	10	1.469,13	
6918012		TO18001012	12	2443	NR	10	1.603,20	
6918013		TO18001013	13	2647	NR	10	1.736,45	
6918014		TO18001014	14	2850	NR	10	1.870,51	
6918015		TO18001015	15	3054	NR	10	2.003,79	
6918016		TO18001016	16	3258	NR	10	2.137,04	

serie	codice	sigla	numero elementi	watt Δt 50°C	UM	cat.	prezzo (€)
TONALE 2000	6920004	TO20001004	4	888	NR	10	564,20
	6920005	TO20001005	5	1110	NR	10	704,65
	6920006	TO20001006	6	1332	NR	10	845,88
	6920007	TO20001007	7	1554	NR	10	987,14
	6920008	TO20001008	8	1776	NR	10	1.128,37
	6920009	TO20001009	9	1998	NR	10	1.268,82
	6920010	TO20001010	10	2220	NR	10	1.410,08
	6920011	TO20001011	11	2442	NR	10	1.551,31
	6920012	TO20001012	12	2664	NR	10	1.691,76
	6920013	TO20001013	13	2886	NR	10	1.833,02
	6920014	TO20001014	14	3108	NR	10	1.974,25
	6920015	TO20001015	15	3330	NR	10	2.114,70
	6920016	TO20001016	16	3552	NR	10	2.255,96

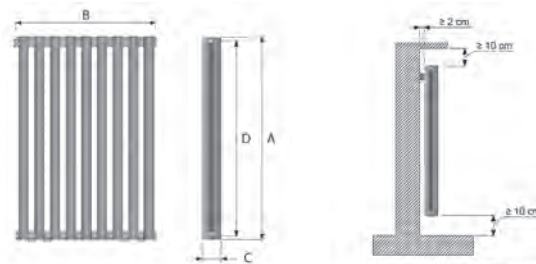

Nella posa dei radiatori si ottiene la resa termica prevista osservando le distanze di seguito precisate:
 ≥ cm 2 dalla parete
 ≥ cm 10 dal pavimento
 ≥ cm 10 dalla mensola o sottofinestra

Per evitare che le dilatazioni termiche dell'impianto provochino rumorosità in corrispondenza dei corpi scaldanti si consiglia di posizionare le apposite mensole alla medesima distanza dagli elementi esterni.

TABELLA DI CONFIGURAZIONE PER RADIATORI: ANTEPRIMA, TONALE E SEBINO

Collegamento idraulico

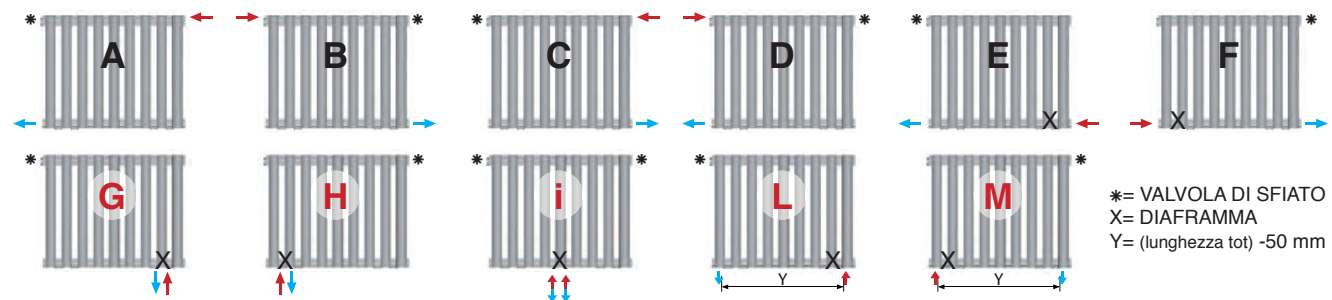

Le configurazioni: **G, H, I, L, M** prevedono una maggiorazione di costo (cod. 5899999)

Con i radiatori modello Tonale e Sebino **non si possono utilizzare le valvole monotubo** in quanto non è possibile inserire la sonda.
 Negli impianti monotubo i radiatori Tonale e Sebino **devono essere installati con apposite valvole** (esempio a lato), con interasse 50 mm., nelle configurazioni G-H-i (schema sopra).



Configurazione fronte elementi TONALE



RADIATORI IN ALLUMINIO

MODELLO SEBINO

350 - 500 - 530 - 600 - 623 - 700

IN ALLUMINIO ESTRUSO

modello	dimensioni in mm				Ø attacchi	potenza termica UNI EN 442 watt	
	A	B	C	D		Δt 30°C	Δt 50°C
	altezza tot.	lunghezza	profondità	interasse			
SEBINO 350	384	-	60	350	1/2"	36,6	71,1
SEBINO 500	534	-	60	500	1/2"	46,9	91,6
SEBINO 530	564	-	60	530	1/2"	48,8	95,5
SEBINO 600	634	-	60	600	1/2"	53,2	104,5
SEBINO 623	657	-	60	623	1/2"	54,7	107,4
SEBINO 700	734	-	60	700	1/2"	59,3	116,9
SEBINO 730	764	-	60	730	1/2"	61,1	120,6
SEBINO 800	834	-	60	800	1/2"	65,2	129
SEBINO 813	847	-	60	813	1/2"	65,9	130,5
SEBINO 900	934	-	60	900	1/2"	70,8	140,7
SEBINO 1000	1034	-	60	1000	1/2"	76,3	152,1
SEBINO 1200	1234	-	60	1200	1/2"	87	174,2
SEBINO 1400	1434	-	60	1400	1/2"	97	195,5
SEBINO 1600	1634	-	60	1600	1/2"	107,2	216,1
SEBINO 1735	1769	-	60	1735	1/2"	113,9	229,6
SEBINO 1800	1834	-	60	1800	1/2"	117,1	236,1
SEBINO 2000	2034	-	60	2000	1/2"	127,2	256,4

**BIANCO
RAL
9010**



Accessori a corredo:

- n. 2 mensole fino a 8 elementi
 - n. 3 mensole da 10 a 24 elementi
 - n. 1 tappo destro D.1/2" bianco
 - n. 1 valvola sfogo manuale D.1/2" bianca
- Le griglie sono fornite dello stesso colore del radiatore

L'ordine del modello SEBINO deve sempre contenere le specifiche del collegamento idraulico (vedi schema a pag. 269)

serie	codice	sigla	nr. elem.	B lungh.	watt Δt 50°C	UM	cat.	prezzo (€)	
SEBINO 350	6905035	SE03501005	5	420	356	NR	10	319,20	
	6906035	SE03501006	6	500	427	NR	10	356,72	
	6907035	SE03501007	7	580	498	NR	10	399,00	
	6908035	SE03501008	8	660	569	NR	10	442,90	
	6909035	SE03501009	9	740	640	NR	10	486,78	
	6910035	SE03501010	10	820	711	NR	10	533,06	
	6911035	SE03501011	11	900	782	NR	10	578,56	
	6912035	SE03501012	12	980	853	NR	10	624,04	
	6913035	SE03501013	13	1060	924	NR	10	670,32	
	6914035	SE03501014	14	1140	995	NR	10	714,22	
	SEBINO 500	6905050	SE05001005	5	420	458	NR	10	349,52
		6906050	SE05001006	6	500	550	NR	10	397,40
		6907050	SE05001007	7	580	641	NR	10	448,48
		6908050	SE05001008	8	660	733	NR	10	497,17
6909050		SE05001009	9	740	824	NR	10	550,62	
6910050		SE05001010	10	820	916	NR	10	601,69	
6911050		SE05001011	11	900	1008	NR	10	652,76	
6912050		SE05001012	12	980	1099	NR	10	701,46	
6913050		SE05001013	13	1060	1191	NR	10	754,12	
6914050		SE05001014	14	1140	1282	NR	10	804,38	
SEBINO 530	6905053	SE05301005	5	420	478	NR	10	363,10	
	6906053	SE05301006	6	500	573	NR	10	409,39	
	6907053	SE05301007	7	580	669	NR	10	462,84	
	6908053	SE05301008	8	660	764	NR	10	512,32	
	6909053	SE05301009	9	740	860	NR	10	566,58	
	6910053	SE05301010	10	820	955	NR	10	620,06	
	6911053	SE05301011	11	900	1051	NR	10	674,32	
	6912053	SE05301012	12	980	1146	NR	10	722,20	
	6913053	SE05301013	13	1060	1242	NR	10	774,06	
	6914053	SE05301014	14	1140	1337	NR	10	828,32	

serie	codice	sigla	nr. elem.	B lungh.	watt Δt 50°C	UM	cat.	prezzo (€)
SEBINO 600	6905060	SE06001005	5	420	523	NR	10	375,06
	6906060	SE06001006	6	500	627	NR	10	424,54
	6907060	SE06001007	7	580	732	NR	10	478,80
	6908060	SE06001008	8	660	836	NR	10	533,88
	6909060	SE06001009	9	740	941	NR	10	590,52
	6910060	SE06001010	10	820	1045	NR	10	644,78
	6911060	SE06001011	11	900	1150	NR	10	702,24
	6912060	SE06001012	12	980	1254	NR	10	754,12
	6913060	SE06001013	13	1060	1359	NR	10	813,96
	6914060	SE06001014	14	1140	1463	NR	10	868,22
SEBINO 623	6905062	SE06231005	5	420	537	NR	10	383,04
	6906062	SE06231006	6	500	644	NR	10	437,30
	6907062	SE06231007	7	580	752	NR	10	494,76
	6908062	SE06231008	8	660	859	NR	10	549,84
	6909062	SE06231009	9	740	967	NR	10	606,48
	6910062	SE06231010	10	820	1074	NR	10	663,94
	6911062	SE06231011	11	900	1181	NR	10	722,20
	6912062	SE06231012	12	980	1289	NR	10	776,47
	6913062	SE06231013	13	1060	1396	NR	10	833,92
	6914062	SE06231014	14	1140	1504	NR	10	893,76
SEBINO 700	6905070	SE07001005	5	420	585	NR	10	395,02
	6906070	SE07001006	6	500	701	NR	10	452,48
	6907070	SE07001007	7	580	818	NR	10	512,32
	6908070	SE07001008	8	660	935	NR	10	569,77
	6909070	SE07001009	9	740	1052	NR	10	630,42
	6910070	SE07001010	10	820	1169	NR	10	691,88
	6911070	SE07001011	11	900	1286	NR	10	754,12
	6912070	SE07001012	12	980	1403	NR	10	813,96
	6913070	SE07001013	13	1060	1520	NR	10	873,82
	6914070	SE07001014	14	1140	1637	NR	10	932,06

730 - 800 - 813 - 900 - 1000 - 1200 - 1400 - 1600 - 1735 - 1800 - 2000

serie	codice	sigla	nr. elem.	B lungh.	watt Δt 50°C	UM	cat.	prezzo (€)	
SEBINO 730	6905073	SE07301005	5	420	603	NR	10	406,98	
	6906073	SE07301006	6	500	724	NR	10	466,03	
	6907073	SE07301007	7	580	844	NR	10	526,68	
	6908073	SE07301008	8	660	965	NR	10	586,54	
	6909073	SE07301009	9	740	1085	NR	10	650,38	
	6910073	SE07301010	10	820	1206	NR	10	712,63	
	6911073	SE07301011	11	900	1327	NR	10	778,06	
	6912073	SE07301012	12	980	1447	NR	10	837,90	
	6913073	SE07301013	13	1060	1568	NR	10	897,76	
	6914073	SE07301014	14	1140	1688	NR	10	957,60	
	SEBINO 800	6905080	SE08001005	5	420	645	NR	10	414,96
		6906080	SE08001006	6	500	774	NR	10	478,80
		6907080	SE08001007	7	580	903	NR	10	542,64
		6908080	SE08001008	8	660	1032	NR	10	601,69
6909080		SE08001009	9	740	1161	NR	10	670,32	
6910080		SE08001010	10	820	1290	NR	10	735,76	
6911080		SE08001011	11	900	1419	NR	10	802,00	
6912080		SE08001012	12	980	1548	NR	10	862,65	
6913080		SE08001013	13	1060	1677	NR	10	929,68	
6914080		SE08001014	14	1140	1806	NR	10	995,12	
SEBINO 813		6905081	SE08131005	5	420	653	NR	10	438,90
		6906081	SE08131006	6	500	783	NR	10	502,74
		6907081	SE08131007	7	580	914	NR	10	566,58
		6908081	SE08131008	8	660	1044	NR	10	632,02
	6909081	SE08131009	9	740	1175	NR	10	702,24	
	6910081	SE08131010	10	820	1305	NR	10	772,46	
	6911081	SE08131011	11	900	1436	NR	10	841,90	
	6912081	SE08131012	12	980	1566	NR	10	905,74	
	6913081	SE08131013	13	1060	1697	NR	10	973,56	
	6914081	SE08131014	14	1140	1827	NR	10	1.045,38	
	SEBINO 900	6904090	SE09001004	4	340	563	NR	10	399,00
		6905090	SE09001005	5	420	704	NR	10	458,86
		6906090	SE09001006	6	500	844	NR	10	521,11
		6907090	SE09001007	7	580	985	NR	10	598,50
6908090		SE09001008	8	660	1126	NR	10	670,32	
6909090		SE09001009	9	740	1266	NR	10	746,14	
6910090		SE09001010	10	820	1407	NR	10	821,16	
6911090		SE09001011	11	900	1548	NR	10	893,76	
6912090		SE09001012	12	980	1688	NR	10	961,60	
6913090		SE09001013	13	1060	1829	NR	10	1.033,42	
6914090		SE09001014	14	1140	99	NR	10	1.102,84	
SEBINO 1000		6904100	SE10001004	4	340	608	NR	10	422,94
		6905100	SE10001005	5	420	761	NR	10	491,57
		6906100	SE10001006	6	500	913	NR	10	563,39
	6907100	SE10001007	7	580	1065	NR	10	638,40	
	6908100	SE10001008	8	660	1217	NR	10	714,22	
	6909100	SE10001009	9	740	1369	NR	10	790,02	
	6910100	SE10001010	10	820	1521	NR	10	868,22	
	6911100	SE10001011	11	900	1673	NR	10	945,64	
	6912100	SE10001012	12	980	1825	NR	10	1.018,25	
	6913100	SE10001013	13	1060	1977	NR	10	1.093,26	
	6914100	SE10001014	14	1140	2129	NR	10	1.169,08	

serie	codice	sigla	nr. elem.	B lungh.	watt Δt 50°C	UM	cat.	prezzo (€)	
SEBINO 1200	6904120	SE12001004	4	340	697	NR	10	437,30	
	6905120	SE12001005	5	420	871	NR	10	526,68	
	6906120	SE12001006	6	500	1045	NR	10	615,27	
	6907120	SE12001007	7	580	1219	NR	10	706,24	
	6908120	SE12001008	8	660	1394	NR	10	783,64	
	6909120	SE12001009	9	740	1568	NR	10	869,82	
	6910120	SE12001010	10	820	1742	NR	10	952,81	
	SEBINO 1400	6904140	SE14001004	4	340	782	NR	10	473,23
		6905140	SE14001005	5	420	978	NR	10	571,37
		6906140	SE14001006	6	500	1173	NR	10	670,32
6907140		SE14001007	7	580	1369	NR	10	766,08	
6908140		SE14001008	8	660	1564	NR	10	862,65	
6909140		SE14001009	9	740	1760	NR	10	953,62	
6910140		SE14001010	10	820	1955	NR	10	1.046,98	
SEBINO 1600		6904160	SE16001004	4	340	864	NR	10	528,28
		6905160	SE16001005	5	420	1081	NR	10	633,61
		6906160	SE16001006	6	500	1297	NR	10	726,99
	6907160	SE16001007	7	580	1513	NR	10	829,92	
	6908160	SE16001008	8	660	1729	NR	10	933,66	
	6909160	SE16001009	9	740	1945	NR	10	1.037,40	
	6910160	SE16001010	10	820	2161	NR	10	1.139,54	
	SEBINO 1735	6904173	SE17351004	4	340	918	NR	10	554,62
		6905173	SE17351005	5	420	1148	NR	10	664,75
		6906173	SE17351006	6	500	1378	NR	10	762,89
6907173		SE17351007	7	580	1607	NR	10	873,82	
6908173		SE17351008	8	660	1837	NR	10	979,94	
6909173		SE17351009	9	740	2066	NR	10	1.089,28	
6910173		SE17351010	10	820	2296	NR	10	1.195,40	
SEBINO 1800		6904180	SE18001004	4	340	944	NR	10	557,00
		6905180	SE18001005	5	420	1181	NR	10	666,34
		6906180	SE18001006	6	500	1417	NR	10	783,64
	6907180	SE18001007	7	580	1653	NR	10	897,76	
	6908180	SE18001008	8	660	1889	NR	10	1.005,48	
	6909180	SE18001009	9	740	2125	NR	10	1.117,20	
	6910180	SE18001010	10	820	2361	NR	10	1.227,32	
	SEBINO 2000	6904200	SE20001004	4	340	1026	NR	10	578,56
		6905200	SE20001005	5	420	1282	NR	10	706,24
		6906200	SE20001006	6	500	1538	NR	10	841,90
6907200		SE20001007	7	580	1795	NR	10	961,60	
6908200		SE20001008	8	660	2051	NR	10	1.077,30	
6909200		SE20001009	9	740	2308	NR	10	1.197,00	
6910200		SE20001010	10	820	2564	NR	10	1.315,92	

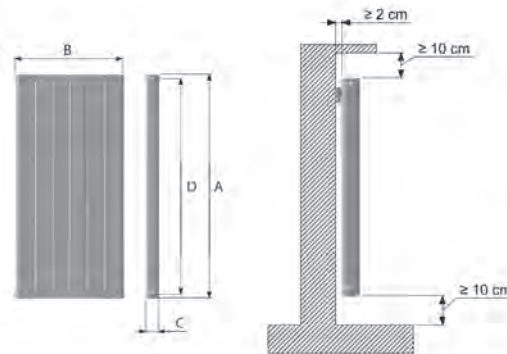

Nella posa dei radiatori si ottiene la resa termica prevista osservando le distanze di seguito precisate:
 ≥ cm 2 dalla parete
 ≥ cm 10 dal pavimento
 ≥ cm 10 dalla mensola o sottofinestra
 Per evitare che le dilatazioni termiche dell'impianto provochino rumorosità in corrispondenza dei corpi scaldanti si consiglia l'impiego delle specifiche mensole plastificate per il sostegno dei radiatori fornite a corredo.

RADIATORI IN ALLUMINIO

MODELLO MIX

350 - 500 - 600 - 700 - 800

IN ALLUMINIO PRESSOFUSO

modello	dimensioni in mm				Ø attacchi	peso a vuoto kg circa	contenuto acqua in litri	potenza termica UNI EN 442	
	A	B	C	D				watt	
	altezza tot.	lunghezza	profondità	interasse				Δt 30°C	Δt 50°C
MIX 300	390	80	95	300	1"	1,00	0,33	43	82
MIX 350	440	80	95	350	1"	1,13	0,36	48	94
MIX 500	590	80	95	500	1"	1,61	0,40	63	123
MIX 600	690	80	95	600	1"	1,65	0,48	72	142
MIX 700	790	80	95	700	1"	2,02	0,54	82	161
MIX 800	890	80	95	800	1"	2,16	0,60	91	180



serie	codice	sigla	numero elementi	watt Δt 50°C	UM	cat.	prezzo (€)
MIX 350	6000004	MX03501001	1	94	el.	10	23,55
	6802004	MX03501002	2	188	bat.	10	47,10
	6803004	MX03501003	3	282	bat.	10	70,62
	6804004	MX03501004	4	376	bat.	10	94,16
	6805004	MX03501005	5	470	bat.	10	117,71
	6806004	MX03501006	6	564	bat.	10	141,26
	6807004	MX03501007	7	658	bat.	10	164,78
	6808004	MX03501008	8	752	bat.	10	188,33
	6809004	MX03501009	9	846	bat.	10	211,88
	6810004	MX03501010	10	940	bat.	10	235,42
	6811004	MX03501011	11	1.034	bat.	10	258,94
	6812004	MX03501012	12	1.128	bat.	10	282,49
	6813004	MX03501013	13	1.222	bat.	10	306,04
	6814004	MX03501014	14	1.316	bat.	10	329,59
MIX 500	6000003	MX05001001	1	123	el.	10	23,94
	6802003	MX05001002	2	246	bat.	10	47,88
	6803003	MX05001003	3	369	bat.	10	71,82
	6804003	MX05001004	4	492	bat.	10	95,76
	6805003	MX05001005	5	615	bat.	10	119,70
	6806003	MX05001006	6	738	bat.	10	143,64
	6807003	MX05001007	7	861	bat.	10	167,58
	6808003	MX05001008	8	984	bat.	10	191,52
	6809003	MX05001009	9	1.107	bat.	10	215,46
	6810003	MX05001010	10	1.230	bat.	10	239,40
	6811003	MX05001011	11	1.353	bat.	10	263,34
	6812003	MX05001012	12	1.476	bat.	10	287,28
	6813003	MX05001013	13	1.599	bat.	10	311,22
	6814003	MX05001014	14	1.722	bat.	10	335,16
MIX 600	6000002	MX06001001	1	142	el.	10	24,98
	6802002	MX06001002	2	284	bat.	10	49,95
	6803002	MX06001003	3	426	bat.	10	74,93
	6804002	MX06001004	4	568	bat.	10	99,90
	6805002	MX06001005	5	710	bat.	10	124,88
	6806002	MX06001006	6	852	bat.	10	149,86
	6807002	MX06001007	7	994	bat.	10	174,83
	6808002	MX06001008	8	1.136	bat.	10	199,81
	6809002	MX06001009	9	1.278	bat.	10	224,78
	6810002	MX06001010	10	1.420	bat.	10	249,79
	6811002	MX06001011	11	1.562	bat.	10	274,76
	6812002	MX06001012	12	1.704	bat.	10	299,74
	6813002	MX06001013	13	1.846	bat.	10	324,72
	6814002	MX06001014	14	1.988	bat.	10	349,69

serie	codice	sigla	numero elementi	watt Δt 50°C	UM	cat.	prezzo (€)
MIX 700	6000001	MX07001001	1	161	el.	10	28,73
	6802001	MX07001002	2	322	bat.	10	57,46
	6803001	MX07001003	3	483	bat.	10	86,18
	6804001	MX07001004	4	644	bat.	10	114,91
	6805001	MX07001005	5	805	bat.	10	143,64
	6806001	MX07001006	6	966	bat.	10	172,37
	6807001	MX07001007	7	1.127	bat.	10	201,10
	6808001	MX07001008	8	1.288	bat.	10	229,82
	6809001	MX07001009	9	1.449	bat.	10	258,55
	6810001	MX07001010	10	1.610	bat.	10	287,28
	6811001	MX07001011	11	1.771	bat.	10	316,01
	6812001	MX07001012	12	1.932	bat.	10	344,74
MIX 800	6000000	MX08001001	1	180	el.	10	30,72
	6802000	MX08001002	2	360	bat.	10	61,46
	6803000	MX08001003	3	540	bat.	10	92,18
	6804000	MX08001004	4	720	bat.	10	122,89
	6805000	MX08001005	5	900	bat.	10	153,61
	6806000	MX08001006	6	1.080	bat.	10	184,35
	6807000	MX08001007	7	1.260	bat.	10	215,07
	6808000	MX08001008	8	1.440	bat.	10	245,78
	6809000	MX08001009	9	1.620	bat.	10	276,50
	6810000	MX08001010	10	1.800	bat.	10	307,24
	6811000	MX08001011	11	1.980	bat.	10	337,96
	6812000	MX08001012	12	2.160	bat.	10	368,68



Nota: L'ELEMENTO SINGOLO NON E' ORDINABILE

350 - 500 - 600 - 700 - 800

IN ALLUMINIO PRESSOFUSO

modello	dimensioni in mm				Ø attacchi	peso a vuoto kg circa	contenuto acqua in litri	potenza termica UNI EN 442 watt	
	A altezza tot.	B lunghezza	C profondità	D interasse				Δt 30°C	Δt 50°C
VOX 350	440	80	95	350	1"	1,12	0,35	49	95
VOX 500	590	80	95	500	1"	1,45	0,46	65	127
VOX 600	690	80	95	600	1"	1,68	0,50	75	146
VOX 700	790	80	95	700	1"	1,95	0,53	83	164
VOX 800	890	80	95	800	1"	2,21	0,56	92	181



serie	codice	sigla	numero elementi	watt Δt 50°C	UM	cat.	prezzo (€)
VOX 350	6000204	VX03501001	1	95	el.	10	23,55
	6802204	VX03501002	2	190	bat.	10	47,10
	6803204	VX03501003	3	285	bat.	10	70,62
	6804204	VX03501004	4	380	bat.	10	94,16
	6805204	VX03501005	5	475	bat.	10	117,71
	6806204	VX03501006	6	570	bat.	10	141,26
	6807204	VX03501007	7	665	bat.	10	164,78
	6808204	VX03501008	8	760	bat.	10	188,33
	6809204	VX03501009	9	855	bat.	10	211,88
	6810204	VX03501010	10	950	bat.	10	235,42
	6811204	VX03501011	11	1.045	bat.	10	258,94
	6812204	VX03501012	12	1.140	bat.	10	282,49
	6813204	VX03501013	13	1.235	bat.	10	306,04
	6814204	VX03501014	14	1.330	bat.	10	329,59
VOX 500	6000203	VX05001001	1	127	el.	10	23,94
	6802203	VX05001002	2	254	bat.	10	47,88
	6803203	VX05001003	3	381	bat.	10	71,82
	6804203	VX05001004	4	508	bat.	10	95,76
	6805203	VX05001005	5	635	bat.	10	119,70
	6806203	VX05001006	6	762	bat.	10	143,64
	6807203	VX05001007	7	889	bat.	10	167,58
	6808203	VX05001008	8	1.016	bat.	10	191,52
	6809203	VX05001009	9	1.143	bat.	10	215,46
	6810203	VX05001010	10	1.270	bat.	10	239,40
	6811203	VX05001011	11	1.397	bat.	10	263,34
	6812203	VX05001012	12	1.524	bat.	10	287,28
	6813203	VX05001013	13	1.651	bat.	10	311,22
	6814203	VX05001014	14	1.778	bat.	10	335,16
VOX 600	6000202	VX06001001	1	146	el.	10	24,98
	6802202	VX06001002	2	292	bat.	10	49,95
	6803202	VX06001003	3	438	bat.	10	74,93
	6804202	VX06001004	4	584	bat.	10	99,90
	6805202	VX06001005	5	730	bat.	10	124,88
	6806202	VX06001006	6	876	bat.	10	149,86
	6807202	VX06001007	7	1.022	bat.	10	174,83
	6808202	VX06001008	8	1.168	bat.	10	199,81
	6809202	VX06001009	9	1.314	bat.	10	224,78
	6810202	VX06001010	10	1.460	bat.	10	249,79
	6811202	VX06001011	11	1.606	bat.	10	274,76
	6812202	VX06001012	12	1.752	bat.	10	299,74
	6813202	VX06001013	13	1.898	bat.	10	324,72
	6814202	VX06001014	14	2.044	bat.	10	349,69

serie	codice	sigla	numero elementi	watt Δt 50°C	UM	cat.	prezzo (€)
VOX 700	6000201	VX07001001	1	164	el.	10	28,73
	6802201	VX07001002	2	328	bat.	10	57,46
	6803201	VX07001003	3	492	bat.	10	86,18
	6804201	VX07001004	4	656	bat.	10	114,91
	6805201	VX07001005	5	820	bat.	10	143,64
	6806201	VX07001006	6	984	bat.	10	172,37
	6807201	VX07001007	7	1.148	bat.	10	201,10
	6808201	VX07001008	8	1.312	bat.	10	229,82
	6809201	VX07001009	9	1.476	bat.	10	258,55
	6810201	VX07001010	10	1.640	bat.	10	287,28
	6811201	VX07001011	11	1.804	bat.	10	316,01
	6812201	VX07001012	12	1.968	bat.	10	344,74
VOX 800	6000200	VX08001001	1	181	el.	10	30,72
	6802200	VX08001002	2	362	bat.	10	61,46
	6803200	VX08001003	3	543	bat.	10	92,18
	6804200	VX08001004	4	724	bat.	10	122,89
	6805200	VX08001005	5	905	bat.	10	153,61
	6806200	VX08001006	6	1.086	bat.	10	184,35
	6807200	VX08001007	7	1.267	bat.	10	215,07
	6808200	VX08001008	8	1.448	bat.	10	245,78
	6809200	VX08001009	9	1.629	bat.	10	276,50
	6810200	VX08001010	10	1.810	bat.	10	307,24
	6811200	VX08001011	11	1.991	bat.	10	337,96
	6812200	VX08001012	12	2.172	bat.	10	368,68



Nota: L'ELEMENTO SINGOLO NON E' ORDINABILE

RADIATORI IN ALLUMINIO

MODELLO VOX EXTRA

350 - 500 - 600 - 700 - 800

IN ALLUMINIO PRESSOFUSO

modello	dimensioni in mm				Ø attacchi	peso a vuoto kg circa	contenuto acqua in litri	potenza termica UNI EN 442 watt	
	A altezza tot.	B lunghezza	C profondità	D interasse				Δt 30°C	Δt 50°C
VOX EXTRA 350	427	80	95	350	1"	0,99	0,36	46	89
VOX EXTRA 500	577	80	95	500	1"	1,28	0,44	61	119
VOX EXTRA 600	677	80	95	600	1"	1,48	0,49	71	137
VOX EXTRA 700	777	80	95	700	1"	1,66	0,55	80	156
VOX EXTRA 800	877	80	95	800	1"	1,85	0,58	88	173

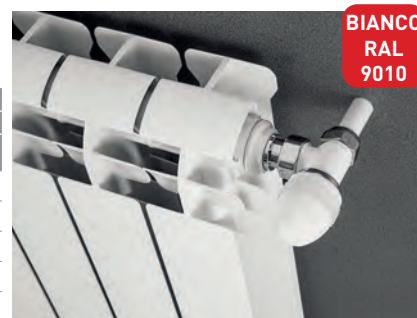

BIANCO
RAL
9010

serie	codice	sigla	numero elementi	watt Δt 50°C	UM	cat.	prezzo (€)
VOX EXTRA 350	6000214	VXE03501001	1	89	el.	10	22,51
	6802214	VXE03501002	2	178	bat.	10	45,00
	6803214	VXE03501003	3	267	bat.	10	67,51
	6804214	VXE03501004	4	356	bat.	10	90,02
	6805214	VXE03501005	5	445	bat.	10	112,53
	6806214	VXE03501006	6	534	bat.	10	135,02
	6807214	VXE03501007	7	623	bat.	10	157,53
	6808214	VXE03501008	8	712	bat.	10	180,04
	6809214	VXE03501009	9	801	bat.	10	202,52
	6810214	VXE03501010	10	890	bat.	10	225,04
	6811214	VXE03501011	11	979	bat.	10	247,55
	6812214	VXE03501012	12	1.068	bat.	10	270,03
	6813214	VXE03501013	13	1.157	bat.	10	292,54
	6814214	VXE03501014	14	1.246	bat.	10	315,06
VOX EXTRA 500	6000213	VXE05001001	1	119	el.	10	22,90
	6802213	VXE05001002	2	238	bat.	10	45,81
	6803213	VXE05001003	3	357	bat.	10	68,71
	6804213	VXE05001004	4	476	bat.	10	91,62
	6805213	VXE05001005	5	595	bat.	10	114,52
	6806213	VXE05001006	6	714	bat.	10	137,42
	6807213	VXE05001007	7	833	bat.	10	160,33
	6808213	VXE05001008	8	952	bat.	10	183,23
	6809213	VXE05001009	9	1.071	bat.	10	206,14
	6810213	VXE05001010	10	1.190	bat.	10	229,04
	6811213	VXE05001011	11	1.309	bat.	10	251,92
	6812213	VXE05001012	12	1.428	bat.	10	274,82
	6813213	VXE05001013	13	1.547	bat.	10	297,72
	6814213	VXE05001014	14	1.666	bat.	10	320,63
VOX EXTRA 600	6000212	VXE06001001	1	137	el.	10	23,94
	6802212	VXE06001002	2	274	bat.	10	47,88
	6803212	VXE06001003	3	411	bat.	10	71,82
	6804212	VXE06001004	4	548	bat.	10	95,76
	6805212	VXE06001005	5	685	bat.	10	119,70
	6806212	VXE06001006	6	822	bat.	10	143,64
	6807212	VXE06001007	7	959	bat.	10	167,58
	6808212	VXE06001008	8	1.096	bat.	10	191,52
	6809212	VXE06001009	9	1.233	bat.	10	215,46
	6810212	VXE06001010	10	1.370	bat.	10	239,40
	6811212	VXE06001011	11	1.507	bat.	10	263,34
	6812212	VXE06001012	12	1.644	bat.	10	287,28
	6813212	VXE06001013	13	1.781	bat.	10	311,22
	6814212	VXE06001014	14	1.918	bat.	10	335,16

serie	codice	sigla	numero elementi	watt Δt 50°C	UM	cat.	prezzo (€)
VOX EXTRA 700	6000211	VXE07001001	1	156	el.	10	27,38
	6802211	VXE07001002	2	312	bat.	10	54,74
	6803211	VXE07001003	3	468	bat.	10	82,12
	6804211	VXE07001004	4	624	bat.	10	109,48
	6805211	VXE07001005	5	780	bat.	10	136,86
	6806211	VXE07001006	6	936	bat.	10	164,22
	6807211	VXE07001007	7	1.092	bat.	10	191,60
	6808211	VXE07001008	8	1.248	bat.	10	218,96
	6809211	VXE07001009	9	1.404	bat.	10	246,34
	6810211	VXE07001010	10	1.560	bat.	10	273,73
	6811211	VXE07001011	11	1.716	bat.	10	301,08
	6812211	VXE07001012	12	1.872	bat.	10	328,47
VOX EXTRA 800	6000210	VXE08001001	1	173	el.	10	29,54
	6802210	VXE08001002	2	346	bat.	10	59,05
	6803210	VXE08001003	3	519	bat.	10	88,59
	6804210	VXE08001004	4	692	bat.	10	118,10
	6805210	VXE08001005	5	865	bat.	10	147,64
	6806210	VXE08001006	6	1.038	bat.	10	177,16
	6807210	VXE08001007	7	1.211	bat.	10	206,70
	6808210	VXE08001008	8	1.384	bat.	10	236,21
	6809210	VXE08001009	9	1.557	bat.	10	265,75
	6810210	VXE08001010	10	1.730	bat.	10	295,26
	6811210	VXE08001011	11	1.903	bat.	10	324,80
	6812210	VXE08001012	12	2.076	bat.	10	354,31



Nota: L'ELEMENTO SINGOLO NON E' ORDINABILE

350 - 500 - 600 - 700 - 800

IN ALLUMINIO PRESSOFUSO

modello	dimensioni in mm				Ø attacchi	peso a vuoto kg circa	contenuto acqua in litri	potenza termica UNI EN 442 watt	
	A altezza tot.	B lunghezza	C profondità	D interasse				Δt 30°C	Δt 50°C
VIP 350	440	80	95	350	1"	1,13	0,35	48	94
VIP 500	590	80	95	500	1"	1,62	0,39	63	123
VIP 600	690	80	95	600	1"	1,66	0,49	72	142
VIP 700	790	80	95	700	1"	2,05	0,53	82	161
VIP 800	890	80	95	800	1"	2,19	0,59	91	180



serie	codice	sigla	numero elementi	watt Δt 50°C	UM	cat.	prezzo (€)
VIP 350	6000404	VP03501001	1	94	el.	10	23,55
	6802404	VP03501002	2	188	bat.	10	47,10
	6803404	VP03501003	3	282	bat.	10	70,62
	6804404	VP03501004	4	376	bat.	10	94,16
	6805404	VP03501005	5	470	bat.	10	117,71
	6806404	VP03501006	6	564	bat.	10	141,26
	6807404	VP03501007	7	658	bat.	10	164,78
	6808404	VP03501008	8	752	bat.	10	188,33
	6809404	VP03501009	9	846	bat.	10	211,88
	6810404	VP03501010	10	940	bat.	10	235,42
	6811404	VP03501011	11	1.034	bat.	10	258,94
	6812404	VP03501012	12	1.128	bat.	10	282,49
	6813404	VP03501013	13	1.222	bat.	10	306,04
	6814404	VP03501014	14	1.316	bat.	10	329,59
VIP 500	6000403	VP05001001	1	123	el.	10	23,94
	6802403	VP05001002	2	246	bat.	10	47,88
	6803403	VP05001003	3	369	bat.	10	71,82
	6804403	VP05001004	4	492	bat.	10	95,76
	6805403	VP05001005	5	615	bat.	10	119,70
	6806403	VP05001006	6	738	bat.	10	143,64
	6807403	VP05001007	7	861	bat.	10	167,58
	6808403	VP05001008	8	984	bat.	10	191,52
	6809403	VP05001009	9	1.107	bat.	10	215,46
	6810403	VP05001010	10	1.230	bat.	10	239,40
	6811403	VP05001011	11	1.353	bat.	10	263,34
	6812403	VP05001012	12	1.476	bat.	10	287,28
	6813403	VP05001013	13	1.599	bat.	10	311,22
	6814403	VP05001014	14	1.722	bat.	10	335,16
VIP 600	6000402	VP06001001	1	142	el.	10	24,98
	6802402	VP06001002	2	284	bat.	10	49,95
	6803402	VP06001003	3	426	bat.	10	74,93
	6804402	VP06001004	4	568	bat.	10	99,90
	6805402	VP06001005	5	710	bat.	10	124,88
	6806402	VP06001006	6	852	bat.	10	149,86
	6807402	VP06001007	7	994	bat.	10	174,83
	6808402	VP06001008	8	1.136	bat.	10	199,81
	6809402	VP06001009	9	1.278	bat.	10	224,78
	6810402	VP06001010	10	1.420	bat.	10	249,79
	6811402	VP06001011	11	1.562	bat.	10	274,76
	6812402	VP06001012	12	1.704	bat.	10	299,74
	6813402	VP06001013	13	1.846	bat.	10	324,72
	6814402	VP06001014	14	1.988	bat.	10	349,69

serie	codice	sigla	numero elementi	watt Δt 50°C	UM	cat.	prezzo (€)
VIP 700	6000401	VP07001001	1	161	el.	10	28,73
	6802401	VP07001002	2	322	bat.	10	57,46
	6803401	VP07001003	3	483	bat.	10	86,18
	6804401	VP07001004	4	644	bat.	10	114,91
	6805401	VP07001005	5	805	bat.	10	143,64
	6806401	VP07001006	6	966	bat.	10	172,37
	6807401	VP07001007	7	1.127	bat.	10	201,10
	6808401	VP07001008	8	1.288	bat.	10	229,82
	6809401	VP07001009	9	1.449	bat.	10	258,55
	6810401	VP07001010	10	1.610	bat.	10	287,28
	6811401	VP07001011	11	1.771	bat.	10	316,01
	6812401	VP07001012	12	1.932	bat.	10	344,74
VIP 800	6000400	VP08001001	1	180	el.	10	30,72
	6802400	VP08001002	2	360	bat.	10	61,46
	6803400	VP08001003	3	540	bat.	10	92,18
	6804400	VP08001004	4	720	bat.	10	122,89
	6805400	VP08001005	5	900	bat.	10	153,61
	6806400	VP08001006	6	1.080	bat.	10	184,35
	6807400	VP08001007	7	1.260	bat.	10	215,07
	6808400	VP08001008	8	1.440	bat.	10	245,78
	6809400	VP08001009	9	1.620	bat.	10	276,50
	6810400	VP08001010	10	1.800	bat.	10	307,24
	6811400	VP08001011	11	1.980	bat.	10	337,96
	6812400	VP08001012	12	2.160	bat.	10	368,68



Nota: L'ELEMENTO SINGOLO NON E' ORDINABILE

RADIATORI IN ALLUMINIO

MODELLO KLASS

350 - 500 - 600 - 700 - 800

IN ALLUMINIO PRESSOFUSO

modello	dimensioni in mm				Ø attacchi	peso a vuoto kg circa	contenuto acqua in litri	potenza termica UNI EN 442 watt	
	A altezza tot.	B lunghezza	C profondità	D interasse				Δt 30°C	Δt 50°C
KLASS 350	432	80	80	350	1"	1,04	0,37	44	85
KLASS 500	582	80	80	500	1"	1,41	0,44	60	116
KLASS 600	682	80	80	600	1"	1,58	0,50	67	132
KLASS 700	782	80	80	700	1"	1,73	0,54	75	148
KLASS 800	882	80	80	800	1"	1,95	0,58	82	162



BIANCO
RAL
9010

serie	codice	sigla	numero elementi	watt Δt 50°C	UM	cat.	prezzo (€)
KLASS 350	6000104	KL03501001	1	85	el.	10	22,09
	6802104	KL03501002	2	170	bat.	10	44,21
	6803104	KL03501003	3	255	bat.	10	66,30
	6804104	KL03501004	4	340	bat.	10	88,42
	6805104	KL03501005	5	425	bat.	10	110,52
	6806104	KL03501006	6	510	bat.	10	132,64
	6807104	KL03501007	7	595	bat.	10	154,73
	6808104	KL03501008	8	680	bat.	10	176,85
	6809104	KL03501009	9	765	bat.	10	198,94
	6810104	KL03501010	10	850	bat.	10	221,06
	6811104	KL03501011	11	935	bat.	10	243,15
	6812104	KL03501012	12	1.020	bat.	10	265,24
	6813104	KL03501013	13	1.105	bat.	10	287,36
	6814104	KL03501014	14	1.190	bat.	10	309,46
KLASS 500	6000103	KL05001001	1	116	el.	10	22,51
	6802103	KL05001002	2	232	bat.	10	45,00
	6803103	KL05001003	3	348	bat.	10	67,51
	6804103	KL05001004	4	464	bat.	10	90,02
	6805103	KL05001005	5	580	bat.	10	112,53
	6806103	KL05001006	6	696	bat.	10	135,02
	6807103	KL05001007	7	812	bat.	10	157,53
	6808103	KL05001008	8	928	bat.	10	180,04
	6809103	KL05001009	9	1.044	bat.	10	202,52
	6810103	KL05001010	10	1.160	bat.	10	225,04
	6811103	KL05001011	11	1.276	bat.	10	247,55
	6812103	KL05001012	12	1.392	bat.	10	270,03
	6813103	KL05001013	13	1.508	bat.	10	292,54
	6814103	KL05001014	14	1.624	bat.	10	315,06
KLASS 600	6000102	KL06001001	1	132	el.	10	23,55
	6802102	KL06001002	2	264	bat.	10	47,10
	6803102	KL06001003	3	396	bat.	10	70,62
	6804102	KL06001004	4	528	bat.	10	94,16
	6805102	KL06001005	5	660	bat.	10	117,71
	6806102	KL06001006	6	792	bat.	10	141,26
	6807102	KL06001007	7	924	bat.	10	164,78
	6808102	KL06001008	8	1.056	bat.	10	188,33
	6809102	KL06001009	9	1.188	bat.	10	211,88
	6810102	KL06001010	10	1.320	bat.	10	235,42
	6811102	KL06001011	11	1.452	bat.	10	258,94
	6812102	KL06001012	12	1.584	bat.	10	282,49
	6813102	KL06001013	13	1.716	bat.	10	306,04
	6814102	KL06001014	14	1.848	bat.	10	329,59

serie	codice	sigla	numero elementi	watt Δt 50°C	UM	cat.	prezzo (€)
KLASS 700	6000101	KL07001001	1	148	el.	10	26,96
	6802101	KL07001002	2	296	bat.	10	53,96
	6803101	KL07001003	3	444	bat.	10	80,92
	6804101	KL07001004	4	592	bat.	10	107,88
	6805101	KL07001005	5	740	bat.	10	134,88
	6806101	KL07001006	6	888	bat.	10	161,84
	6807101	KL07001007	7	1.036	bat.	10	188,80
	6808101	KL07001008	8	1.184	bat.	10	215,77
	6809101	KL07001009	9	1.332	bat.	10	242,76
	6810101	KL07001010	10	1.480	bat.	10	269,72
	6811101	KL07001011	11	1.628	bat.	10	296,69
	6812101	KL07001012	12	1.776	bat.	10	323,68
KLASS 800	6000100	KL08001001	1	162	el.	10	28,56
	6802100	KL08001002	2	324	bat.	10	57,15
	6803100	KL08001003	3	486	bat.	10	85,71
	6804100	KL08001004	4	648	bat.	10	114,27
	6805100	KL08001005	5	810	bat.	10	142,86
	6806100	KL08001006	6	972	bat.	10	171,42
	6807100	KL08001007	7	1.134	bat.	10	199,98
	6808100	KL08001008	8	1.296	bat.	10	228,54
	6809100	KL08001009	9	1.458	bat.	10	257,12
	6810100	KL08001010	10	1.620	bat.	10	285,68
	6811100	KL08001011	11	1.782	bat.	10	314,24
	6812100	KL08001012	12	1.944	bat.	10	342,83



Nota: L'ELEMENTO SINGOLO NON E' ORDINABILE

RADIATORI IN ALLUMINIO

MODELLO OSCAR

900 - 1000 - 1200 - 1400 - 1600 - 1800 - 2000

IN ALLUMINIO ESTRUSO

modello	dimensioni in mm				Ø attacchi	peso a vuoto kg circa	contenuto acqua in litri	potenza termica UNI EN 442 watt	
	A altezza tot.	B lunghezza	C profondità	D interasse				Δt 30°C	Δt 50°C
OSCAR 900	946	80	95	900	1"	1,99	0,41	88	175
OSCAR 1000	1046	80	95	1000	1"	2,05	0,42	95	190
OSCAR 1200	1246	80	95	1200	1"	2,43	0,49	109	218
OSCAR 1400	1446	80	95	1400	1"	2,80	0,56	123	245
OSCAR 1600	1646	80	95	1600	1"	3,18	0,62	136	271
OSCAR 1800	1846	80	95	1800	1"	3,53	0,69	148	297
OSCAR 2000	2046	80	95	2000	1"	3,86	0,76	161	321



BIANCO
RAL
9010

serie	codice	sigla	numero elementi	watt Δt 50°C	UM	cat.	prezzo (€)
OSCAR 900	6000600	OS09001001	1	175	el.	11	57,86
	6802600	OS09001002	2	350	bat.	11	115,71
	6803600	OS09001003	3	525	bat.	11	173,57
	6804600	OS09001004	4	700	bat.	11	231,42
	6805600	OS09001005	5	875	bat.	11	289,28
	6806600	OS09001006	6	1.050	bat.	11	347,13
	6807600	OS09001007	7	1.225	bat.	11	404,99
	6808600	OS09001008	8	1.400	bat.	11	462,84
OSCAR 1000	6000601	OS10001001	1	190	el.	11	62,81
	6802601	OS10001002	2	380	bat.	11	125,63
	6803601	OS10001003	3	570	bat.	11	188,44
	6804601	OS10001004	4	760	bat.	11	251,26
	6805601	OS10001005	5	950	bat.	11	314,07
	6806601	OS10001006	6	1.140	bat.	11	376,88
	6807601	OS10001007	7	1.330	bat.	11	439,70
	6808601	OS10001008	8	1.520	bat.	11	502,51
OSCAR 1200	6000602	OS12001001	1	218	el.	11	74,39
	6802602	OS12001002	2	436	bat.	11	148,77
	6803602	OS12001003	3	654	bat.	11	223,16
	6804602	OS12001004	4	872	bat.	11	297,54
	6805602	OS12001005	5	1.090	bat.	11	371,93
	6806602	OS12001006	6	1.308	bat.	11	446,31
	6807602	OS12001007	7	1.526	bat.	11	520,70
	6808602	OS12001008	8	1.744	bat.	11	595,08
OSCAR 1400	6000603	OS14001001	1	245	el.	11	82,65
	6802603	OS14001002	2	490	bat.	11	165,30
	6803603	OS14001003	3	735	bat.	11	247,95
	6804603	OS14001004	4	980	bat.	11	330,60
	6805603	OS14001005	5	1.225	bat.	11	413,25
	6806603	OS14001006	6	1.470	bat.	11	495,90
	6807603	OS14001007	7	1.715	bat.	11	578,55
	6808603	OS14001008	8	1.960	bat.	11	661,20

serie	codice	sigla	numero elementi	watt Δt 50°C	UM	cat.	prezzo (€)
OSCAR 1600	6000604	OS16001001	1	271	el.	11	90,92
	6802604	OS16001002	2	542	bat.	11	181,83
	6803604	OS16001003	3	813	bat.	11	272,75
	6804604	OS16001004	4	1.084	bat.	11	363,66
	6805604	OS16001005	5	1.355	bat.	11	454,58
	6806604	OS16001006	6	1.626	bat.	11	545,49
	6807604	OS16001007	7	1.897	bat.	11	636,41
	6808604	OS16001008	8	2.168	bat.	11	727,32
OSCAR 1800	6000605	OS18001001	1	297	el.	11	98,37
	6802605	OS18001002	2	594	bat.	11	196,71
	6803605	OS18001003	3	891	bat.	11	295,08
	6804605	OS18001004	4	1.188	bat.	11	393,41
	6805605	OS18001005	5	1.485	bat.	11	491,78
	6806605	OS18001006	6	1.782	bat.	11	590,12
	6807605	OS18001007	7	2.079	bat.	11	688,49
	6808605	OS18001008	8	2.376	bat.	11	786,83
OSCAR 2000	6000606	OS20001001	1	321	el.	11	109,10
	6802606	OS20001002	2	642	bat.	11	218,20
	6803606	OS20001003	3	963	bat.	11	327,29
	6804606	OS20001004	4	1.284	bat.	11	436,39
	6805606	OS20001005	5	1.605	bat.	11	545,49
	6806606	OS20001006	6	1.926	bat.	11	654,59
	6807606	OS20001007	7	2.247	bat.	11	763,69
	6808606	OS20001008	8	2.568	bat.	11	872,78

Nota: L'ELEMENTO SINGOLO NON E' ORDINABILE



RISCALDAMENTO

RADIATORI IN ALLUMINIO

MODELLO OSCAR TONDO

900 - 1000 - 1200 - 1400 - 1600 - 1800 - 2000

IN ALLUMINIO ESTRUSO

modello	dimensioni in mm				Ø attacchi	peso a vuoto kg circa	contenuto acqua in litri	potenza termica UNI EN 442 watt	
	A altezza tot.	B lunghezza	C profondità	D interasse				Δt 30°C	Δt 50°C
O. TONDO 900	946	80	95	900	1"	1,99	0,41	88	175
O. TONDO 1000	1046	80	95	1000	1"	2,05	0,42	95	190
O. TONDO 1200	1246	80	95	1200	1"	2,43	0,49	109	218
O. TONDO 1400	1446	80	95	1400	1"	2,80	0,56	123	245
O. TONDO 1600	1646	80	95	1600	1"	3,18	0,62	136	271
O. TONDO 1800	1846	80	95	1800	1"	3,53	0,69	148	297
O. TONDO 2000	2046	80	95	2000	1"	3,86	0,76	161	321



BIANCO
RAL
9010

serie	codice	sigla	numero elementi	watt Δt 50°C	UM	cat.	prezzo (€)
OSCAR TONDO 900	6000610	OST09001001	1	175	el.	11	57,86
	6802610	OST09001002	2	350	bat.	11	115,71
	6803610	OST09001003	3	525	bat.	11	173,57
	6804610	OST09001004	4	700	bat.	11	231,42
	6805610	OST09001005	5	875	bat.	11	289,28
	6806610	OST09001006	6	1.050	bat.	11	347,13
	6807610	OST09001007	7	1.225	bat.	11	404,99
	6808610	OST09001008	8	1.400	bat.	11	462,84
OSCAR TONDO 1000	6000611	OST10001001	1	190	el.	11	62,81
	6802611	OST10001002	2	380	bat.	11	125,63
	6803611	OST10001003	3	570	bat.	11	188,44
	6804611	OST10001004	4	760	bat.	11	251,26
	6805611	OST10001005	5	950	bat.	11	314,07
	6806611	OST10001006	6	1.140	bat.	11	376,88
	6807611	OST10001007	7	1.330	bat.	11	439,70
	6808611	OST10001008	8	1.520	bat.	11	502,51
OSCAR TONDO 1200	6000612	OST12001001	1	218	el.	11	74,39
	6802612	OST12001002	2	436	bat.	11	148,77
	6803612	OST12001003	3	654	bat.	11	223,16
	6804612	OST12001004	4	872	bat.	11	297,54
	6805612	OST12001005	5	1.090	bat.	11	371,93
	6806612	OST12001006	6	1.308	bat.	11	446,31
	6807612	OST12001007	7	1.526	bat.	11	520,70
	6808612	OST12001008	8	1.744	bat.	11	595,08
OSCAR TONDO 1400	6000613	OST14001001	1	245	el.	11	82,65
	6802613	OST14001002	2	490	bat.	11	165,30
	6803613	OST14001003	3	735	bat.	11	247,95
	6804613	OST14001004	4	980	bat.	11	330,60
	6805613	OST14001005	5	1.225	bat.	11	413,25
	6806613	OST14001006	6	1.470	bat.	11	495,90
	6807613	OST14001007	7	1.715	bat.	11	578,55
	6808613	OST14001008	8	1.960	bat.	11	661,20

serie	codice	sigla	numero elementi	watt Δt 50°C	UM	cat.	prezzo (€)
OSCAR TONDO 1600	6000614	OST16001001	1	271	el.	11	90,92
	6802614	OST16001002	2	542	bat.	11	181,83
	6803614	OST16001003	3	813	bat.	11	272,75
	6804614	OST16001004	4	1.084	bat.	11	363,66
	6805614	OST16001005	5	1.355	bat.	11	454,58
	6806614	OST16001006	6	1.626	bat.	11	545,49
	6807614	OST16001007	7	1.897	bat.	11	636,41
	6808614	OST16001008	8	2.168	bat.	11	727,32
OSCAR TONDO 1800	6000615	OST18001001	1	297	el.	11	98,37
	6802615	OST18001002	2	594	bat.	11	196,71
	6803615	OST18001003	3	891	bat.	11	295,08
	6804615	OST18001004	4	1.188	bat.	11	393,41
	6805615	OST18001005	5	1.485	bat.	11	491,78
	6806615	OST18001006	6	1.782	bat.	11	590,12
	6807615	OST18001007	7	2.079	bat.	11	688,49
	6808615	OST18001008	8	2.376	bat.	11	786,83
OSCAR TONDO 2000	6000616	OST20001001	1	321	el.	11	109,10
	6802616	OST20001002	2	642	bat.	11	218,20
	6803616	OST20001003	3	963	bat.	11	327,29
	6804616	OST20001004	4	1.284	bat.	11	436,39
	6805616	OST20001005	5	1.605	bat.	11	545,49
	6806616	OST20001006	6	1.926	bat.	11	654,59
	6807616	OST20001007	7	2.247	bat.	11	763,69
	6808616	OST20001008	8	2.568	bat.	11	872,78



Nota: L'ELEMENTO SINGOLO NON E' ORDINABILE

ACCESSORI RADIATORI

KIT TAPPI

Kit composto da n.2 riduzioni destre e n.2 riduzioni sinistre (con guarnizione in silicone montata), tappo cieco con o-ring, valvola sfiato d'aria manuale con anello in teflon, oppure valvola sfiato d'aria girevole con o-ring EPDM e chiavetta di chiusura.

KIT RADIATORI IN ALLUMINIO / ACCIAIO 1"



BIANCO
RAL
9010

codice	flangia Ø	Ø	valvola sfiato	UM	min. ord. conf.	cat.	prezzo (€)
● 5800011	42	1"x3/8"	manuale	NR	25	22	12,60
● 5800012	42	1"x1/2"	manuale	NR	25	22	12,60
● 5800001	42	1"x3/8"	girevole	NR	25	22	12,60
● 5800002	42	1"x1/2"	girevole	NR	25	22	12,60

KIT RADIATORI OSCAR, JUNIOR, EKOS, PLUS



BIANCO
RAL
9010

codice	flangia Ø	Ø	valvola sfiato	UM	min. ord. conf.	cat.	prezzo (€)	
● 6010031	42	1"x3/8"	girevole	NR	1	100	22	18,19
● 6010033	42	1"x1/2"	girevole	NR	1	100	22	18,02

KIT RADIATORI IN GHISA



BIANCO
RAL
9010

codice	flangia Ø	Ø	valvola sfiato	UM	min. ord. conf.	cat.	prezzo (€)	
● 5800031	44,5	1"x3/8"	manuale	NR	1	25	22	17,85
● 5800035	44,5	1"x1/2"	manuale	NR	1	25	22	17,85

KIT RADIATORI IN ACCIAIO 1"1/4



BIANCO
RAL
9010

codice	flangia Ø	Ø	valvola sfiato	UM	min. ord. conf.	cat.	prezzo (€)
● 5800021	56	1"1/4x3/8"	manuale	NR	25	25	31,88
● 5800023	56	1"1/4x1/2"	manuale	NR	25	25	31,88

TAPPI E RIDUZIONI VERNICIATI / ZINCATI

TAPPO CON GUARNIZIONE VERNICIATO RAL 9010

Guarnizione in silicone montata



codice	flangia Ø	A Ø	versione	B (mm)	UM	min. ord.	conf.	cat.	prezzo (€)
● 5810301	42	1"	DX	22	NR	20	100	22	2,10
● 5810302	42	1"	SX	22	NR	20	100	22	2,10
● 5810305	56	1"1/4	DX	24	NR	5	50	22	7,35
● 5810306	56	1"1/4	SX	24	NR	5	50	22	7,35

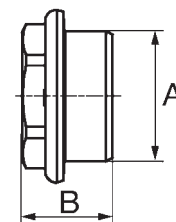

ACCESSORI RADIATORI

TAPPI E RIDUZIONI VERNICIATI / ZINCATI

RIDUZIONE CON GUARNIZIONE VERNICIATA RAL 9010

Guarnizione in silicone montata



codice	flangia Ø	A Ø	C Ø	versione	B (mm)	UM	min. ord.	conf.	cat.	prezzo (€)
● 5810001	42	1"	1/4"	DX	22	NR	20	100	22	2,10
● 5810002	42	1"	1/4"	SX	22	NR	20	100	22	2,10
● 5810003	42	1"	3/8"	DX	22	NR	20	100	22	2,10
● 5810004	42	1"	3/8"	SX	22	NR	20	100	22	2,10
● 5810005	42	1"	1/2"	DX	22	NR	20	100	22	2,10
● 5810006	42	1"	1/2"	SX	22	NR	20	100	22	2,10
● 5810007	42	1"	3/4"	DX	22	NR	20	100	22	2,48
● 5810008	42	1"	3/4"	SX	22	NR	20	100	22	2,48
● 5810017	56	1"1/4	1/4"	DX	24	NR	5	50	22	7,48
● 5810018	56	1"1/4	1/4"	SX	24	NR	5	50	22	7,48
● 5810019	56	1"1/4	3/8"	DX	24	NR	5	50	22	7,48
● 5810020	56	1"1/4	3/8"	SX	24	NR	5	50	22	7,48
● 5810021	56	1"1/4	1/2"	DX	24	NR	5	50	22	7,48
● 5810022	56	1"1/4	1/2"	SX	24	NR	5	50	22	7,48

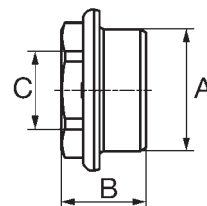

TAPPO ZINCATO



codice	flangia Ø	A Ø	versione	B (mm)	UM	min. ord.	conf.	cat.	prezzo (€)
● 5810601	44,5	1"	DX	22	NR	1	100	22	2,02
● 5810602	44,5	1"	SX	22	NR	1	100	22	2,02
● 5810603	56	1"1/4	DX	24	NR	1	50	22	4,62
● 5810604	56	1"1/4	SX	24	NR	1	50	22	4,62

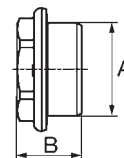

RIDUZIONE ZINCATATA



codice	flangia Ø	A Ø	C Ø	versione	B (mm)	UM	min. ord.	conf.	cat.	prezzo (€)
● 5810100	44,5	1"	1/4"	DX	22	NR	1	100	22	2,02
● 5810101	44,5	1"	1/4"	SX	22	NR	1	100	22	2,02
● 5810102	44,5	1"	3/8"	DX	22	NR	1	100	22	2,02
● 5810103	44,5	1"	3/8"	SX	22	NR	1	100	22	2,02
● 5810104	44,5	1"	1/2"	DX	22	NR	1	100	22	2,02
● 5810105	44,5	1"	1/2"	SX	22	NR	1	100	22	2,02
● 5810108	56	1"1/4	1/4"	DX	24	NR	1	50	22	4,75
● 5810109	56	1"1/4	1/4"	SX	24	NR	1	50	22	4,75
● 5810110	56	1"1/4	3/8"	DX	24	NR	1	50	22	4,75
● 5810111	56	1"1/4	3/8"	SX	24	NR	1	50	22	4,75
● 5810112	56	1"1/4	1/2"	DX	24	NR	1	50	22	4,75
● 5810113	56	1"1/4	1/2"	SX	24	NR	1	50	22	4,75
● 5810114	56	1"1/4	3/4"	DX	24	NR	1	50	22	5,04
● 5810115	56	1"1/4	3/4"	SX	24	NR	1	50	22	5,04
● 5810116	56	1"1/4	1"	DX	24	NR	1	50	22	6,05
● 5810117	56	1"1/4	1"	SX	24	NR	1	50	22	6,05

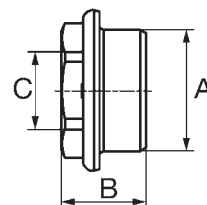

ACCESSORI RADIATORI

CHIAVE PER TAPPI E RIDUZIONI VERNICIATE

In nylon per radiatori Oscar.



codice	sigla	Ø	UM	min. ord.	conf.	cat.	prezzo (€)
● 6010015	A019CHITP	28	NR	1	5	20	12,45

CHIAVE PER TAPPI E RIDUZIONI VERNICIATE

In nylon



codice	Ø	UM	min. ord.	conf.	cat.	prezzo (€)
● 5800061	32-42-48-56	NR	1	10	10	10,69

NIPPLE DX-SX IN ACCIAIO



codice	finitura	Ø	lungh. (mm)	UM	min. ord.	conf.	cat.	prezzo (€)
● 5800033	nero	1"	25,5	NR	1	100	20	1,01
● 5800034	nero	1"1/4	27,5	NR	1	50	20	1,67
● 5800037	zincato	1"	25,5	NR	1	1	20	1,32
● 5800038	zincato	1"1/4	27,5	NR	1	1	20	2,02
● 6010019	x Oscar e Ekos plus	1"	30	NR	1	50	20	1,14

GUARNIZIONE PER TAPPI E RIDUZIONI - ESENTE AMIANTO

Composta da fibre di cellulosa, minerali, legante elastomerico NBR.



codice	flangia Ø	Ø	spessore (mm)	UM	min. ord.	conf.	cat.	prezzo (€)
● 5810401	42	1"	1	NR	100	20	20	0,26
● 5810404	56	1"1/4	2	NR	100	20	20	0,40

GUARNIZIONE PER NIPPLE

Guarnizione bianca per tenuta elementi in alluminio.



codice	flangia Ø	Ø	spessore (mm)	UM	min. ord.	conf.	cat.	prezzo (€)
● 6010007	42	1"	1	NR	100	20	20	0,40

GUARNIZIONE IN CARTONCINO



codice	flangia Ø	Ø	spessore (mm)	UM	min. ord.	conf.	cat.	prezzo (€)
● 5810501	42	1"	0,5	NR	100	20	20	0,09
● 5810502	48	1"	0,5	NR	100	20	20	0,09
● 5810503	56	1"1/4	0,5	NR	100	20	20	0,09

GUARNIZIONE IN SILICONE

In silicone bianco, per tappi e riduzioni flangiati con incavo.



codice	flangia Ø	Ø	spessore (mm)	UM	min. ord.	conf.	cat.	prezzo (€)
● 5810550	42	1"	2,2	NR	100	20	20	0,26

GUARNIZIONE OR PER OSCAR, JUNIOR, EKOS PLUS

In gomma per tenuta elementi e per tappi, riduzioni solo per serie Oscar, Junior, Ekosplus.



codice	flangia Ø	Ø	spessore (mm)	UM	min. ord.	conf.	cat.	prezzo (€)
● 6010020	42	1"	3,2	NR	100	20	20	0,70

VALVOLA SFIATO MANUALE

In ottone nickelato con guarnizione in teflon.

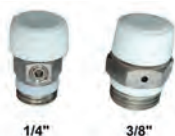

codice	Ø	UM	min. ord.	conf.	cat.	prezzo (€)
● 5800050	1/4"	NR	1	100	20	2,99
● 5800051	3/8"	NR	1	100	20	3,39

VALVOLA SFIATO GIREVOLE

In ottone D. 1/2" con guarnizione o-ring in EPDM, apertura con chiave in nylon.



codice	descrizione	UM	min. ord.	conf.	cat.	prezzo (€)
● 5800040	valvola	NR	1	100	20	2,77
● 5800060	chiave	NR	1	100	20	0,26

DIAFRAMMA PER OSCAR



codice	sigla	misura	UM	min. ord.	conf.	cat.	prezzo (€)
● 6010018	A022DIA0SEK	Ø 1"x75	NR	1	20	20	7,30

BOMBOLETTA SPRAY VERNICE BIANCO RAL9010



codice	sigla	volume	UM	min. ord.	conf.	cat.	prezzo (€)
● 6010009	A010SPY10	ml. 200	NR	1	12	20	14,92

ACCESSORI RADIATORI

MENSOLE VERNICIATE

MENSOLA RADIATORI ALLUMINIO RAL 9010

Il prezzo è riferito alla coppia

versione piatta



versione tonda



codice	versione	dimens. (mm)	tassello (mm)	UM	min. ord.	conf.	cat.	prezzo (€)
● 5860001	piatta	7x170	10	CP	50	50	20	3,43
● 5860002	tonda	7x170	10	CP	1	50	20	3,43
● 5860003	tonda	9x170	12	CP	50	50	20	4,75
● 5860004	tonda	9x190	12	CP	1	50	20	5,28

MENSOLA RADIATORI GHISA RAL 9010

Il prezzo è riferito alla coppia



codice	colonne nr.	dimens. (mm)	tassello (mm)	UM	min. ord.	conf.	cat.	prezzo (€)
● 5862001	2-3	12x200	16	CP	1	25	20	6,38
● 5862002	3-4	12x230	16	CP	1	25	20	7,17
● 5862003	5-6	12x260	16	CP	1	25	20	7,83

MENSOLA RADIATORI ACCIAIO RAL 9010

Il prezzo è riferito alla coppia



codice	colonne nr.	dimens. (mm)	tassello (mm)	mozzo (mm)	UM	min. ord.	conf.	cat.	prezzo (€)
● 5861002	3-4	8,5x220	12	53	CP	1	30	20	6,69
● 5861003	5-6	11,5x270	16	53	CP	1	30	20	10,74
● 5861004	2-3	9x190	12	63	CP	1	40	20	5,59
● 5861005	3-4	9x230	12	63	CP	1	30	20	6,25
● 5861006	5-6	12x265	16	63	CP	1	25	20	9,28

MENSOLA A PAVIMENTO PER RADIATORI RAL 9010



codice	altezza (mm)	mozzo (mm)	UM	min. ord. conf.	cat.	prezzo (€)
● 5863501	137÷190	45	NR	1	22	72,41

ROSETTE

ROSONE PP APRIBILE PER RADIATORI



codice	tubo Ø	Ø (mm)	UM	min. ord. conf.	cat.	prezzo (€)
● 2661021	8-16	60	NR	100	23	0,42

BORCHIA COPRIFORO APRIBILE PER TUBO RAME



codice	tubo Ø	Ø (mm)	UM	min. ord. conf.	cat.	prezzo (€)
● 2750635	8-16	60	NR	100	23	1,38

ROSETTA APRIBILE PER VALVOLE MONOTUBO



codice	tubo Ø	dimensioni (mm)	UM	min. ord. conf.	cat.	prezzo (€)
● 2750630	14-16	90x50	NR	50	23	1,68

CIRCOLATORE PER RISCALDAMENTO E CONDIZIONAMENTO

Circolatore domestico elettronico per riscaldamento e condizionamento, dotato di protezione da funzionamento a secco, cuscinetti in carbonio con assenza totale di piombo secondo le normative. Modalità estiva per prevenire il blocco del motore dopo lunghi periodi di inattività. Incluso guscio isolante in un pezzo unico.

Modalità di funzionamento

- 3 curve a pressione proporzionale (per riscaldamento a radiatori)
- 3 curve a pressione costante (per riscaldamento a pavimento)
- 3 curve a velocità fissa (per boiler e ventilazione)

Caratteristiche
Fluidi consentiti Temperatura min. -10°C, max +110°C
 acqua, fluidi puliti e liberi da particelle solide, glicole max 40%.



CURVE DI LAVORO

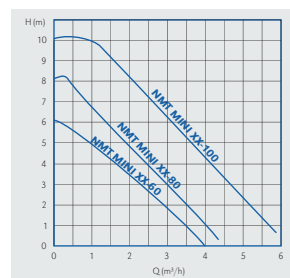
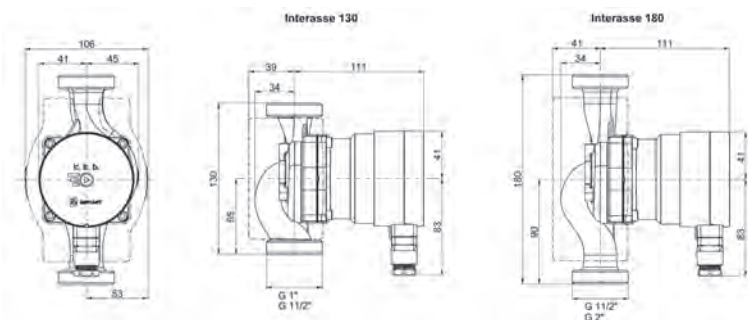

	codice	Modello	Interasse (mm)	Attacchi	UM	min. ord.	conf.	cat.	prezzo (€)
●	5901001	15-60	130	1"	NR	1	30	03	199,32
●	5901002	25-60	130	1"1/2	NR	1	30	03	199,32
●	5901011	25-60	180	1"1/2	NR	1	30	03	199,32
●	5901005	25-80	130	1"1/2	NR	1	30	03	249,48
●	5901014	25-80	180	1"1/2	NR	1	30	03	249,48
●	5901006	25-100	130	1"1/2	NR	1	30	03	403,59
●	5901016	25-100	180	1"1/2	NR	1	30	03	403,59
●	5901013	32-60	180	2"	NR	1	30	03	199,32
●	5901012	32-80	180	2"	NR	1	30	03	249,48
●	5901017	32-100	180	2"	NR	1	30	03	403,59

	codice	descrizione	UM	min. ord.	conf.	cat.	prezzo (€)
●	5901199	connettore x tutti i circolatori Delò	NR	1	1	03	20,07

CIRCOLATORE PER ACQUA CALDA SANITARIA

Circolatore domestico elettronico per acqua calda sanitaria, corpo pompa in acciaio inox, cuscinetti in carbonio con assenza totale di piombo secondo le normative. Tecnologia motore a magneti permanenti ed elettronica con inverter per un risparmio energetico. Un tasto solo per selezionare le modalità di funzionamento.

Modalità di funzionamento

- 3 curve a pressione proporzionale
- 3 curve a pressione costante
- 3 curve a velocità fissa

Caratteristiche
Fluidi consentiti Temperatura min. -10°C, max +110°C
 acqua, fluidi puliti e liberi da particelle solide, senza oli minerali



CURVE DI LAVORO

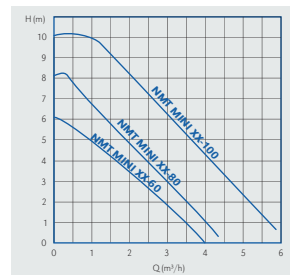
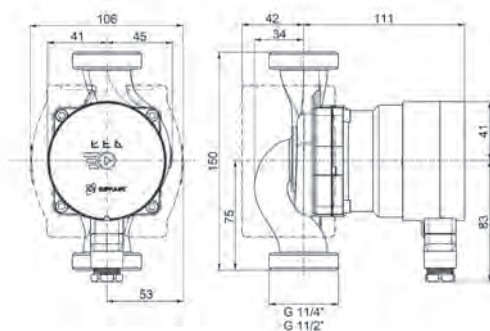

	codice	Modello	Interasse (mm)	Attacchi	UM	min. ord.	conf.	cat.	prezzo (€)
●	5901022	20-60	150	1"1/4	NR	1	16	03	324,39
●	5901020	25-60	150	1"1/2	NR	1	16	03	324,39

RISCALDAMENTO

ACCESSORI SOTTOCALDAIA

POMPE SCARICO CONDENZA

POMPA A PISTONE PER CALDAIA A CONDENSAZIONE



Pompa a pistone per lo smaltimento delle acque acide di condensa di caldaie a gas murali e a terra fino a 50kw. I componenti resistono all'acidità della condensa pertanto non necessita di sali o di neutralizzatore di condensa.

A corredo: dispositivo antisfonaggio per evitare che la pompa lavori a secco; cavo di alimentazione da 1,5mt con connettore e blocco di sicurezza; 5mt di tubo di scarico condensa (6x9) con adattatore multidiametro per il collegamento in ingresso sulla pompa; kit di installazione.

Applicazioni: caldaia

Capacità di scarico verticale: 4 metri (portata 4,5 lt/h)

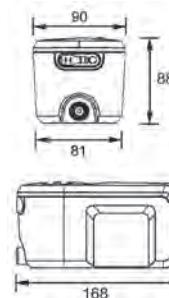

codice	sigla	Nr. entrate	Portata max	Livello sonoro	Serbatoio UM	min. ord.	conf.	cat.	prezzo (€)
● 3351021	SI61CE01UN23	1	10 lt/h	<28dB(A)	370 ml	NR	1	5 03	210,12

SANICONDENS DECO+



Pompa compatta per lo smaltimento delle acque di condensa di caldaie murali a gas fino a 25kw. A corredo: viti di fissaggio, protezione termica calibrata con riarmo automatico.

Applicazioni: caldaia

Capacità di scarico: 6 metri in verticale (tubo Ø 8/10 mm.)
60 metri in orizzontale (tubo Ø 8/10 mm.)

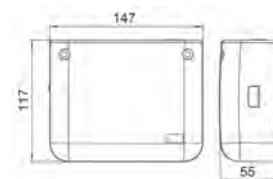

codice	sigla	Nr. entrate	Portata max	Livello sonoro	Serbatoio UM	min. ord.	conf.	cat.	prezzo (€)
● 3350021	SCONDECO+	1	15 lt/h	<25dB(A)	175 ml	NR	1	12 13	173,06

POMPA CENTRIFUGA PER CALDAIA A CONDENSAZIONE



Pompa per lo smaltimento delle acque di condensa di caldaie a gas, climatizzatori e vetrine refrigerate.

A corredo: viti di fissaggio, valvola antiritorno integrata, cavo d'alimentazione da 2 mt.

Applicazioni: caldaia - climatizzatore - vetrina refrigerata - evaporatore

Capacità di scarico: 4,5 metri in verticale
30 metri orizzontale

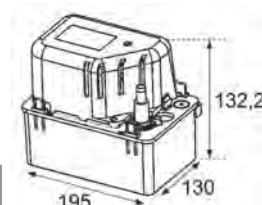

codice	sigla	Nr. entrate	Portata max	Livello sonoro	Serbatoio UM	min. ord.	conf.	cat.	prezzo (€)
● 3351024	SI1805SIUN23	2	500 lt/h	<47 dB(A)	0,5 lt	NR	1	10 03	144,51

SANICONDENS BEST FLAT



Pompa con neutralizzatore incorporato, per preservare i tubi dagli attacchi delle acque acide di condensa, di caldaie a gas (fino a 80kw) e a gasolio (fino a 50kw) sia murali che a terra, deumidificatori e apparecchi refrigeranti.

A corredo: viti di fissaggio, valvola clapet, cavo di alimentazione da 1,5 mt., cavo allarme a 2 fili da 1,5 mt., tubo flessibile di scarico 5 mt, una confezione di granuli Sanisal (3350610).

Applicazioni: caldaia - deumidificatore - banchi frigo

Capacità di scarico: 4,5 metri in verticale (tubo Ø int. 10 mm.)
50 metri orizzontale (tubo Ø int. 10 mm.)

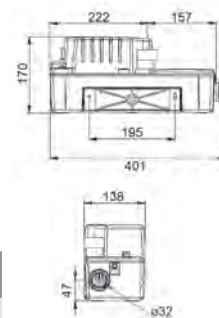

codice	sigla	Nr. entrate	Portata max	Livello sonoro	Serbatoio UM	min. ord.	conf.	cat.	prezzo (€)
● 3350028	SCONBFLAT	3	360 lt/h	<45 dB(A)	3,5 lt	NR	1	17	313,22

SANICONDENS PRO



Pompa con serbatoio di grande capacità per lo smaltimento delle acque di condensa di caldaie a gas murali e terra fino a 50kw.

A corredo: viti di fissaggio, valvola clapet, cavo d'alimentazione da 1,5 mt., cavo di allarme pre-connesso, tubo di scarico in gomma da 5 mt.

Applicazioni: caldaia - climatizzatore - deumidificatore - climatizzatore a soffitto - banchi refrigeranti

Capacità di scarico: 4,5 metri in verticale (tubo Ø 8/10 mm.)
50 metri in orizzontale (tubo Ø 8/10 mm.)

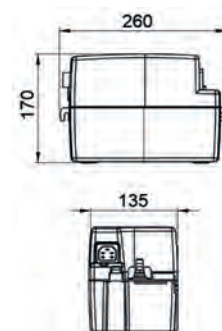

codice	sigla	Nr. entrate	Portata max	Livello sonoro	Serbatoio UM	min. ord.	conf.	cat.	prezzo (€)
● 3350024	SCONPRO21	2	372 lt/h	<45 dB(A)	2,2 lt	NR	1	13	166,88

SANINEUTRAL MINI



Neutralizzatore di condensa per caldaie murali fino a 25kw., ingombro ridotto. Possibile collegamento superiore o laterale. Diametro 32 mm. A corredo: supporti di fissaggio, una confezione di granuli Sanisal (3350610).

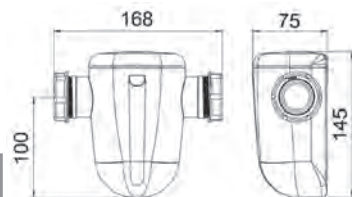

codice	sigla	pH min.	filtro	UM	min. ord. conf.	cat.	prezzo (€)
● 3350011	NEUTRALMINISTD	2,5	grani	NR	1	13	107,48

SANINEUTRAL



Neutralizzatore di condensa per caldaie a gas (fino a 50 kw) e a gasolio (fino a 35 kw) sia murali che a terra. Diametro di scarico 40 mm. Può essere installato con Sanicondens Mini (3350022) e Sanicondens Pro (3350024). A corredo: supporti di fissaggio, una confezione di granuli Sanisal (3350610).

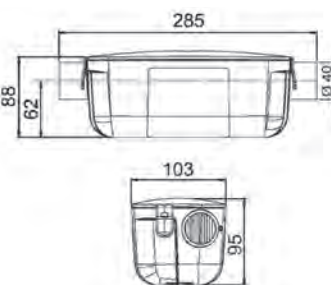

codice	sigla	pH min.	filtro	UM	min. ord. conf.	cat.	prezzo (€)
● 3350010	SANINEUT	2,5	grani	NR	1	13	147,08

NEUTRA SLIM



Neutralizzatore di condensa per caldaie murali fino a 35kw, con capacità di scambio da pH acido a pH neutro. Installazione sia verticale che orizzontale, dotata di by-pass che impedisce il ritorno in caldaia della condensa trattata. E' necessario sostituire la cartuccia periodicamente

codice	descrizione	UM	min. ord.	conf.	cat.	prezzo (€)
● 2006014	neutralizzatore	NR	1	12	04	78,43
● 2006015	cartuccia	NR	1	12	04	26,94

NEUTRA CONDENS



Neutralizzatore di condensa per caldaie murali fino a 35kw. Installazione sia verticale che orizzontale. E' necessario sostituire periodicamente i granuli all'interno del filtro.

A corredo: kit fissaggio, coppia di raccordi portagomma in PP da 3/4"(DN16)

codice	descrizione	UM	min. ord.	conf.	cat.	prezzo (€)
● 2006018	neutralizzatore	NR	1	36	22	48,68

RICARICA NEUTRA CONDENS



Granuli di carbonato di calcio che permettono di neutralizzare l'acidità delle acque di condensa delle caldaie. Per Neutra Condens (2006018)

codice	contenuto (gr)	UM	min. ord.	conf.	cat.	prezzo (€)
● 2006019	300	NR	1	18	04	18,76

SANISAL GRANULI DI NEUTRALIZZAZIONE



Granuli di sale che permettono di neutralizzare l'acidità delle acque di condensa delle caldaie. Da sostituire circa una volta all'anno. Per Sanicondens Deco+ (3350021), Sanicondens Best (3350025), Sanineutral Mini (3350011), Sanineutral (33500100).

codice	sigla	descrizione	UM	min. ord.	conf.	cat.	prezzo (€)
● 3350610	SANISALBT	bottiglia da 1,2kg	NR	1	6	13	61,78

ACCESSORI SOTTOCALDAIA

DOSATORI

DOSATORE POLIFOSFATI CON GHIERA

Con by-pass e attacchi con ghiera.
Compreso chiave e una ricarica.

Dosaggio proporzionale 2/4 ppm mg/lt
Portata 1,5 mc/h
Pressione massima 3,5 bar
Temperatura massima 45°C
Perdita di carico 0,2 bar
Autonomia ricarica 12-15 mc



RICAMBI:

2007030 - Bicchieri

codice	attacchi	UM	min. ord.	conf.	cat.	prezzo (€)
● 2007010	F/F 1/2"	NR	1	30	03	44,22

DOSATORE POLIFOSFATI CON DIMA

Con by-pass e DIMA, attacchi con ghiera.
Compreso chiave e una ricarica.

Dosaggio proporzionale 2/4 ppm mg/lt
Portata 1,5 mc/h
Pressione massima 3,5 bar
Temperatura massima 45°C
Perdita di carico 0,2 bar
Autonomia ricarica 12-15 mc



RICAMBI:

2007030 - Bicchieri

codice	attacchi	UM	min. ord.	conf.	cat.	prezzo (€)
● 2007011	F/F 1/2"	NR	1	30	03	44,22

RICARICA POLIFOSFATI IN POLVERE



codice	descrizione	UM	min. ord.	conf.	cat.	prezzo (€)
● 2007012	confez. 6 capsule	NR	1	12	09	14,96
● 2007013	barattolo da 1 kg	NR	1	12	09	27,28

RICARICA POLIFOSFATI LIQUIDO

Soluzione di polifosfati ad uso alimentare per il trattamento dell'acqua potabile con durezza medio-alta. Previene le incrostazioni e la corrosione negli impianti sanitari domestici. Conforme alla normativa CE per suo alimentare.

Specifico per pompe dosatrici

Dosaggio 10-25 gr/mc
Temperatura massima 60°C in accumulo, 80°C istantanea
Durezza acqua tra 5°F e 35°F



codice	descrizione	UM	min. ord.	conf.	cat.	prezzo (€)
● 2007015	bottiglia da 1 litro	NR	6	6	09	21,12

DOSATORE POLIFOSFATI 360°

Ideale per grandi tubazioni. Con by-pass.
Compreso chiave e una ricarica.

Dosaggio proporzionale 2/4 ppm x mc
Portata 5,8 mc/h
Pressione d'esercizio 2-10bar
Temperatura massima 45°C
Perdita di carico 0,2 bar
Autonomia ricarica 40 mc



codice	attacchi	UM	min. ord.	conf.	cat.	prezzo (€)
● 2007019	3/4" F - 1" F	NR	1	12	03	178,20

RICARICA POLIFOSFATI PER 2007019



codice	descrizione	UM	min. ord.	conf.	cat.	prezzo (€)
● 2007023	confez. 4 capsule	NR	1	12	09	60,08

BICCHIERE PER DOSATORE POLIFOSFATI

NOVITÀ!



COMPATIBILITÀ:

2007010 - dosatore con ghiera
 2007011 - dosatore con dima

codice	descrizione	UM	min. ord.	conf.	cat.	prezzo (€)
● 2007030	colore blu	NR	1	1	09	8,48

RISCALDAMENTO

DEFANGATORE MAGNETICO

Possibile installazione in orizzontale ed in verticale.

DATI TECNICI

Pressione di esercizio: 3bar

Temperatura di esercizio: 0 ÷ 90° C

Portata: 5,4 m³/h

Campo magnetico: 11.000 Gauss

Grado di filtrazione: 800 micron

Dimensioni: H.80mm; L.135mm; Ø66mm



codice	Ø	UM	min. ord.	conf.	cat.	prezzo (€)
2007055	3/4"	NR	1	12	06	65,34

KIT SOTTOCALDAIA DEFANGATORE E DOSATORE

Composto da:



Defangatore magnetico (2007055)



Dosatore polifosfati con attacchi da 1/2"

By-pass integrato

Portata max: 1,5 m³/h

Pressione max: 8 bar



codice	descrizione	UM	min. ord. conf.	cat.	prezzo (€)
2007059	Kit	NR	1	06	118,40

ACCESSORI SOTTOCALDAIA

DEFANGATORI

DEFANGATORE TF1 TOTAL FILTER



Filtro idro-ciclonico magnetico per rimuovere fanghi e contaminanti magnetici e non, in circuiti termici.

Grado di filtrazione: 0,7 µm. Capacità di contenimento di 400 gr. di fanghi senza perdita di carico.

Può essere installato su tubazioni sia verticali che orizzontali.

A corredo: 2 valvole, una confezione di F9 Protector + Filterfluid da 500 ml. (2009009).

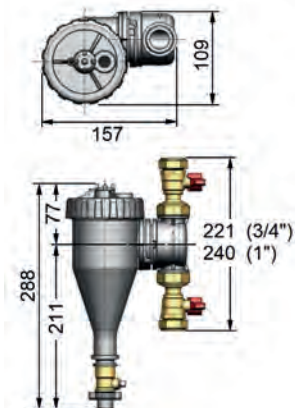

	codice	sigla	Ø	UM	min. ord. conf.	cat.	prezzo (€)
●	2009203	59256	3/4"	NR	1	11	367,69
●	2009204	52257	1"	NR	1	11	367,69

DEFANGATORE TF1 COMPACT



Filtro idro-ciclonico magnetico (versione compatta) per rimuovere fanghi e contaminanti magnetici e non, in circuiti termici.

Grado di filtrazione: 0,7 µm. Capacità di contenimento di 300 gr. di fanghi senza perdita di carico.

Può essere installato su tubazioni sia verticali che orizzontali.

A corredo: 2 valvole, una confezione di F9 Protector + Filterfluid da 500 ml. (2009009)

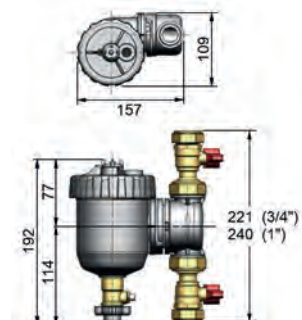

	codice	sigla	Ø	UM	min. ord. conf.	cat.	prezzo (€)
●	2009201	62131	3/4"	NR	1	11	335,07
●	2009202	62132	1"	NR	1	11	335,07

F9 PROTECTOR + FILTER FLUID ml.500



Abbinato ad un defangatore magnetico, protegge l'impianto dalla corrosione e dalle incrostazioni. Miscela di disperdenti che porta in sospensione le impurità convogliandole nel filtro. E' possibile quindi lasciarlo all'interno dell'impianto senza effettuare il risciacquo.

	codice	sigla	UM	min. ord. conf.	cat.	prezzo (€)	
●	2009009	62235	NR	1	10	05	57,79

JRGURED RIDUTTORE DI PRESSIONE PN25

Il corpo in bronzo offre una maggiore precisione e stabilità nel tempo in quanto meno soggetto a corrosioni. Corsore cilindrico e sede in acciaio inossidabile, membrana e guarnizione della valvola in EPDM, attacco per il manometro da ambedue le parti. Riduttore rinomato per la sua precisione a valle, grazie ai tre cilindri che permettono un movimento equilibrato in tutte le situazioni. Filtro in acciaio inox a maglia larga 1000 µm, tazza del filtro in bronzo. In posizione orizzontale permette una rapida pulizia senza intervenire sul meccanismo. Completo di raccordi in ottone.

Installabile in qualsiasi posizione.

Temperatura: max. 70°C

Regolazione di fabbrica: 400 kPa (4 bar)

Pressione secondaria: 200 - 600 kPa (2 - 6 bar)

Pressione nominale: 2500 kPa (25 bar)

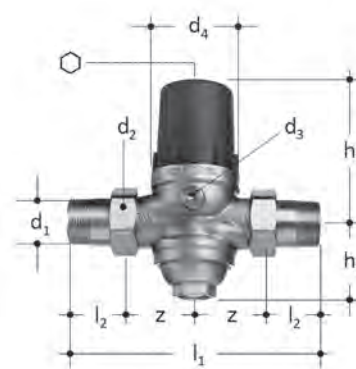

GN	DN	d1 R	d2 G	d3 Rp	d4	h1	h2	l1	l2	z	⬡
(")	(mm)	(")	(")	(")	(mm)	(mm)	(mm)	(mm)	(mm)	(mm)	
½	15	½	¾	⅛	53	34	79	130	25	40	5
¾	20	¾	1	⅛	53	42	81	142	29	43	5
1	25	1	1¼	¼	60	55	90	167	34	50	5
1¼	32	1¼	1½	¼	72	67	109	196	38	60	6
1½	40	1½	1¾	¼	80	80	122	222	39	73	8

codice	∅	DN	attacco manometro	UM	min. ord. conf.	cat.	prezzo (€)
● 2900000	1/2"	15	1/8"	NR	1	13	176,53
● 2900001	3/4"	20	1/8"	NR	1	17	206,41
● 2900002	1"	25	1/4"	NR	1	17	291,41
● 2900003	1"1/4	32	1/4"	NR	1	17	364,29
● 2900004	1"1/2	40	1/4"	NR	1	17	619,29

MANOMETRI E TERMOMETRI

MANOMETRI

MANOMETRO ATTACCO RADIALE



INFORMAZIONI TECNICHE

Cassa	ABS
Vetro	Plastica (Lustran)
Quadrante	ABS
Classe	1,6
Elemento	Molte lega rame
Temperatura esercizio	-20° / +80°C
Conforme	UNI EN 837-1 NORME INAIL

codice	Ø	scala (bar)	attacco	UM	min. ord. conf.	cat.	prezzo (€)
1001004	50	0÷4	1/4"	NR	1	09	8,00
1001005	50	0÷6	1/4"	NR	1	09	7,84
1001006	50	0÷10	1/4"	NR	1	09	8,00
1002004	63	0÷4	1/4"	NR	1	09	8,64
1002005	63	0÷6	1/4"	NR	1	09	8,44
1002006	63	0÷10	1/4"	NR	1	09	8,64
1002007	63	0÷16	1/4"	NR	1	09	8,64
1002008	63	0÷25	1/4"	NR	1	09	8,64
1003005	80	0÷6	3/8"	NR	1	09	15,04
1003006	80	0÷10	3/8"	NR	1	09	15,04
1004003	100	0÷6	1/2"	NR	1	09	21,92
1004004	100	0÷10	1/2"	NR	1	09	21,92

MANOMETRO ATTACCO POSTERIORE



INFORMAZIONI TECNICHE

Cassa	ABS
Vetro	Plastica (Lustran)
Quadrante	ABS
Classe	1,6
Elemento	Molte lega rame
Temperatura esercizio	-20° / +80°C
Conforme	UNI EN 837-1 NORME INAIL

codice	Ø	scala (bar)	attacco	UM	min. ord. conf.	cat.	prezzo (€)
1011007	50	0÷6	1/8"	NR	1	09	8,40
1011008	50	0÷10	1/8"	NR	1	09	8,40
1011003	50	0÷6	1/4"	NR	1	09	8,48
1011004	50	0÷10	1/4"	NR	1	09	8,40
1012002	63	0÷4	1/4"	NR	1	09	8,80
1012003	63	0÷6	1/4"	NR	1	09	8,60
1012004	63	0÷10	1/4"	NR	1	09	8,80
1012005	63	0÷16	1/4"	NR	1	09	9,16

MANOMETRO PER GAS BASSA PRESSIONE OMOLOGATO INAIL



INFORMAZIONI TECNICHE

Cassa	Acciaio nichelato
Vetro	Plastica (Lustran)
Quadrante	Alluminio
Classe	1,6
Elemento	Polmone (soffietto)
Temperatura esercizio	-20° / +80°C
Conforme	UNI EN 837-1 NORME INAIL

codice	Ø	scala (Mbar)	attacco	UM	min. ord. conf.	cat.	prezzo (€)
1021001	63	0÷60	1/4"	NR	1	09	48,12
1021002	63	0÷100	1/4"	NR	1	09	48,12
1021004	63	0÷250	1/4"	NR	1	09	48,12
1021006	63	0÷600	1/4"	NR	1	09	48,44

MANOMETRO IN BAGNO DI GLICERINA ATTACCO RADIALE



INFORMAZIONI TECNICHE

Cassa	Acciaio inox
Vetro	Plastica (Lustran)
Quadrante	ABS
Classe	1,6
Elemento	Molte lega rame
Temperatura esercizio	-20° / +80°C
Conforme	UNI EN 837-1 NORME INAIL

codice	Ø	scala (bar)	attacco	UM	min. ord. conf.	cat.	prezzo (€)
1031009	63	0÷6	1/4"	NR	1	09	21,08
1031010	63	0÷10	1/4"	NR	1	09	21,08
1031011	63	0÷16	1/4"	NR	1	09	21,08
1031012	63	0÷25	1/4"	NR	1	09	21,08

TERMOMANOMETRO



INFORMAZIONI TECNICHE

Cassa	ABS
Vetro	Plastica (Lustran)
Quadrante	ABS
Classe	1,6
Elemento	Molte lega rame
Temperatura esercizio	-20° / +80°C
Conforme	UNI EN 837-1 NORME INAIL

codice	Ø	scala (bar)	scala (°C)	attacco	UM	min. ord. conf.	cat.	prezzo (€)
1041002	80	0÷6	0÷120	Radiale	NR	1	09	23,96
1041003	80	0÷6	0÷120	Posteriore	NR	1	09	26,36

TERMOMETRO A CONTATTO



INFORMAZIONI TECNICHE

Cassa	Acciaio
Vetro	Plexiglas
Quadrante	Alluminio
Classe	±2°C
Elemento	Spirale bimetallica
Temperatura esercizio	-20° / +80°C
Conforme	UNI EN 13190 NORME INAIL

codice	∅	scala (°C)	attacco	UM	min. ord. conf.	cat.	prezzo (€)
● 1121001	63	0÷120	Con molla	NR	1	03	11,67

TERMOMETRO AD IMMERSIONE ATTACCO RADIALE



INFORMAZIONI TECNICHE

Cassa	Acciaio
Vetro	Plexiglas
Quadrante	Alluminio
Classe	±2°C
Pozzetto in ottone	Compreso
Elemento	Spirale bimetallica
Temperatura esercizio	-20° / +80°C
Conforme	UNI EN 13190 NORME INAIL

codice	∅	scala (°C)	gambo (cm)	UM	min. ord. conf.	cat.	prezzo (€)
● 1101003	80	0÷120	5	NR	1	03	16,41
● 1101103	80	0÷120	10	NR	1	03	18,15

TERMOMETRO AD IMMERSIONE ATTACCO POSTERIORE



INFORMAZIONI TECNICHE

Cassa	Acciaio
Vetro	Plexiglas
Quadrante	Alluminio
Classe	±2°C
Pozzetto in ottone	Compreso
Elemento	Spirale bimetallica
Temperatura esercizio	-20° / +80°C
Conforme	UNI EN 13190 NORME INAIL

codice	∅	scala (°C)	gambo (cm)	UM	min. ord. conf.	cat.	prezzo (€)
● 1111003	63	0÷120	5 cm.	NR	1	03	11,22
● 1111103	63	0÷120	10 cm.	NR	1	03	12,60
● 1112003	80	0÷120	5 cm.	NR	1	03	13,11
● 1112103	80	0÷120	10 cm.	NR	1	03	18,12

TERMOMETRO AD IMMERSIONE ATTACCO POSTERIORE



INFORMAZIONI TECNICHE

Cassa	Acciaio
Vetro	Plexiglas
Quadrante	Alluminio
Classe	±2°C
Pozzetto in ottone	Compreso
Elemento	Spirale bimetallica
Temperatura esercizio	-20° / +80°C
Conforme	UNI EN 13190 NORME INAIL

codice	∅	scala (°C)	gambo (cm)	UM	min. ord. conf.	cat.	prezzo (€)
● 1112001	80	-30/+50	5 cm.	NR	1	03	14,37
● 1112101	80	-30/+50	10 cm.	NR	1	03	16,62

ACCESSORI MANOMETRI E TERMOMETRI

RUBINETTO PORTAMANOMETRO A 3 VIE CON FLANGIA

Maschio/Femmina
PN10
Conforme norme INAIL



codice	∅	UM	min. ord. conf.	cat.	prezzo (€)
● 1201001	1/4"	NR	1	09	24,40
● 1201002	3/8"	NR	1	09	26,76
● 1201003	1/2"	NR	1	09	29,00

RUBINETTO PORTAMANOMETRO A PULSANTE

PN10



codice	∅	UM	min. ord. conf.	cat.	prezzo (€)
● 1202002	3/8"	NR	1	10	22,32

SERPENTINA PORTAMANOMETRO M/F

PN16
Girevole in rame nichelato



codice	∅	UM	min. ord. conf.	cat.	prezzo (€)
● 1203001	1/4"	NR	1	09	14,28
● 1203002	3/8"	NR	1	09	16,12
● 1203003	1/2"	NR	1	09	19,08

POZZETTO TERMOMETRICO IN OTTONE



codice	∅	gambo (cm)	UM	min. ord. conf.	cat.	prezzo (€)
● 1204001	1/2"	5	NR	1	09	7,04
● 1204002	1/2"	10	NR	1	09	10,72

CATALOGO
LISTINO N° 8

IMPIANTISTICA

MULTISTRATO	294
RACCORDERIA IN OTTONE	302
RACCORDERIA IN RAME-BRONZO	319
RACCORDERIA PER TUBO POLIETILENE	337
GIUNTI ESTENSIBILI ED ANTIVIBRANTI GAS E ACQUA	343
TUBO SOLARE	348
ISOLAMENTO IN GOMMA	350
ISOLAMENTO IN POLIETILENE	353



MULTISTRATO

TUBO MULTISTRATO GAS

Sistema di tubi multistrato **PE-X/Al/PE-X** per adduzione di gas combustibile secondo normativa UNI 11344, omologato per metano e GPL (installazione secondo UNI 7129:2015). Il tubo multistrato è composto da 5 strati: uno strato interno realizzato in polietilene reticolato PE-Xb, uno di collante, uno strato di alluminio, un altro di collante e uno strato esterno realizzato ancora in polietilene reticolato PE-Xb di colore giallo.



TUBO NUDO IN ROTOLI COLORE GIALLO



codice	sigla	d _e x e (mm)	UM	rotolo min.ord.	conf. mt x pallet	cat.	prezzo (€)
4890201	2402001620100	16x2	MT	100	1100	05	2,37
4890202	2402002020100	20x2	MT	100	800	05	3,23
4890203	2402002630050	26x3	MT	50	400	05	6,27
4890204	2402003230050	32x3	MT	50	300	05	8,96

TUBO IN ROTOLI IN GUAINA CORRUGATA GIALLA

Guaina di protezione in PP



codice	sigla	d _e x e (mm)	dg (min.)	UM	rotolo min.ord.	conf. mt x pallet	cat.	prezzo (€)
4890401	2522051620050	16x2	25,0	MT	50	800	05	4,13
4890402	2522052020050	20x2	28,8	MT	50	750	05	5,66
4890403	2522052630050	26x3	36,0	MT	50	500	05	11,81

LEGENDA

d_e = diametro esterno

e = spessore tubo

S-iso = spessore isolamento

dg = diametro guaina

RACCORDI IN OTTONE A PRESSARE PER MULTISTRATO GAS

Sistema di raccordi in ottone a pressare con 2 OR di tenuta idraulica in mescola HNBR. Utilizzabili con diversi profili di pinzatura:

Profilo ganascia	Ø 16	Ø 20	Ø 26	Ø 32
TH	X	X	X	X
H	X	X	X	X
U	X	X		X



MANICOTTO



codice	sigla	Ø	UM	min. ord.	conf.	cat.	prezzo (€)
4853001	4101160000001	16	NR	5	40	03	7,26
4853002	4101200000001	20	NR	5	40	03	10,26
4853003	4101260000001	26	NR	5	20	03	12,84

MANICOTTO DI RIDUZIONE



codice	sigla	Ø	UM	min. ord.	conf.	cat.	prezzo (€)
4853101	4102201600001	20x16	NR	5	40	03	8,76
4853102	4102261600001	26x16	NR	5	30	03	11,10
4853103	4102262000001	26x20	NR	5	20	03	11,61

RACCORDO MASCHIO



codice	sigla	Ø	UM	min. ord.	conf.	cat.	prezzo (€)
4853201	4103160002001	16x1/2"	NR	5	40	03	5,76
4853202	4103160003001	16x3/4"	NR	5	30	03	6,51
4853203	4103200002001	20x1/2"	NR	5	40	03	6,75
4853204	4103200003001	20x3/4"	NR	5	30	03	10,50
4853206	4103260003001	26x3/4"	NR	5	30	03	9,51
4853208	4103320004001	32x1"	NR	5	20	03	15,51

RACCORDO FEMMINA



codice	sigla	Ø	UM	min. ord.	conf.	cat.	prezzo (€)
4853301	4104160002001	16x1/2"	NR	5	40	03	6,03
4853302	4104160003001	16x3/4"	NR	5	30	03	7,41
4853303	4104200002001	20x1/2"	NR	5	40	03	6,87
4853304	4104200003001	20x3/4"	NR	5	30	03	9,75
4853306	4104260003001	26x3/4"	NR	5	20	03	10,59
4853307	4104260004001	26x1"	NR	5	15	03	12,90
4853308	4104320004001	32x1"	NR	5	15	03	15,69

RACCORDI IN OTTONE A PRESSARE PER MULTISTRATO GAS

RACCORDO DIRITTO FEMMINA CON DADO GIREVOLE



codice	sigla	Ø	UM	min. ord.	conf.	cat.	prezzo (€)
4854101	4114160003001	16x3/4"	NR	5	40	03	7,41
4854102	4114200003001	20x3/4"	NR	5	40	03	8,07
4854103	4114260003001	26x3/4"	NR	5	30	03	13,38

GOMITO A 90° CON DERIVAZIONE MASCHIO



codice	sigla	Ø	UM	min. ord.	conf.	cat.	prezzo (€)
4853701	4108160002001	16x1/2"	NR	5	40	03	7,26
4853702	4108200002001	20x1/2"	NR	5	30	03	9,21
4853703	4108200003001	20x3/4"	NR	5	20	03	10,71
4853704	4108260003001	26x3/4"	NR	5	20	03	14,64

GOMITO A 90° CON DERIVAZIONE FEMMINA



codice	sigla	Ø	UM	min. ord.	conf.	cat.	prezzo (€)
4853801	4109160002001	16x1/2"	NR	5	30	03	7,47
4853802	4109200002001	20x1/2"	NR	5	30	03	8,91
4853803	4109200003001	20x3/4"	NR	5	25	03	10,62
4853805	4109260003001	26x3/4"	NR	5	20	03	16,11

GOMITO A 90°



codice	sigla	Ø	UM	min. ord.	conf.	cat.	prezzo (€)
4853501	4106160000001	16	NR	5	30	03	8,16
4853502	4106200000001	20	NR	5	30	03	11,25
4853503	4106260000001	26	NR	5	15	03	17,13

RACCORDO MURALE A GOMITO



codice	sigla	Ø	UM	min. ord.	conf.	cat.	prezzo (€)
4854201	4134160002001	16x1/2"	NR	5	15	03	10,71
4854202	4134200002001	20x1/2"	NR	5	15	03	11,55

TEE A 90°



codice	sigla	Ø	UM	min. ord.	conf.	cat.	prezzo (€)
4853401	4105160000001	16	NR	2	20	03	11,76
4853402	4105200000001	20	NR	2	16	03	15,39

TEE A 90° CON DERIVAZIONE MASCHIO



codice	sigla	Ø	UM	min. ord.	conf.	cat.	prezzo (€)
4853901	4110160002001	16x1/2"x16	NR	2	20	03	14,49
4853902	4110200002001	20x1/2"x20	NR	2	16	03	15,18

TEE A 90° CON DERIVAZIONE FEMMINA



codice	sigla	Ø	UM	min. ord.	conf.	cat.	prezzo (€)
4853601	4107160002001	16x1/2"x16	NR	2	20	03	11,49
4853602	4107200002001	20x1/2"x20	NR	2	16	03	15,33
4853605	4107260003001	26x3/4"x26	NR	2	10	03	25,23

TEE A 90° RIDOTTO



codice	sigla	Ø	UM	min. ord.	conf.	cat.	prezzo (€)
4854001	4113162016001	16x20x16	NR	2	16	03	12,99
4854002	4113201616001	20x16x16	NR	2	16	03	13,83
4854003	4113201620001	20x16x20	NR	2	16	03	14,58
4854004	4113202016001	20x20x16	NR	2	16	03	14,94
4854010	4113262026001	26x20x26	NR	2	12	03	23,82

MULTISTRATO

TUBO MULTISTRATO ACQUA

Sistema di tubi multistrato **PE-RT/Al/PE-RT** per la distribuzione di acqua calda e fredda ad uso sanitario, per gli impianti di riscaldamento a basse ed alte temperature. Il tubo multistrato è composto da 5 strati: uno strato interno realizzato in polietilene reticolato PE-RT TYPE II, uno di adesivo, uno strato di alluminio Stark, un altro di adesivo e uno strato esterno realizzato ancora in polietilene reticolato PE-RT TYPE II. La versione preisolata è realizzata con un rivestimento in polietilene espanso (Euroclasse B_L - s1 - d0), rifinito con una pellicola esterna estrusa colorata. Temperatura massima 93°C, pressione massima 10 bar.



TUBO NUDO IN ROTOLI

Per uso sanitario e riscaldamento.



codice	sigla	d _e x e (mm)	UM	rotolo min.ord.	conf. mt x pallet	cat.	prezzo (€)
4891202	2410001620100	16x2	MT	100	2100	05	1,76
4891203	2410001620200	16x2	MT	200	2400	05	1,76
4891204	2410001620240	16x2	MT	240	1920	05	1,76
4891205	2410001620300	16x2	MT	300	2400	05	1,76
4891206	2410001620500	16x2	MT	500	3000	05	1,86
4891209	2410002020100	20x2	MT	100	1300	05	2,40
4891211	2410002630050	26x3	MT	50	700	05	4,67
4891212	2410003230050	32x3	MT	50	650	05	6,62

TUBO NUDO IN BARRE

Per uso sanitario e riscaldamento.



codice	sigla	d _e x e (mm)	UM	barra (mt)	fascio min.ord.	cat.	prezzo (€)
4891301	2410001620005	16x2	MT	5	125	05	2,21
4891302	2410002020005	20x2	MT	5	75	05	3,01
4891304	2410002630005	26x3	MT	5	45	05	5,86
4891305	2410003230005	32x3	MT	5	30	05	8,35
4891306	2410004035004	40x3,5	MT	4	36	05	18,18
4891307	2410005040004	50x4	MT	4	28	05	27,30
4891308	2410006345004	63x4,5	MT	4	16	05	40,03

TUBO PREISOLATO IN ROTOLI COLORE AZZURRO

Per uso sanitario e riscaldamento.
Spessore isolamento conforme alla legge 10/91 ad esclusione dell'articolo 4891109.



codice	sigla	d _e x e (mm)	S-iso (mm)	UM	rotolo min.ord.	conf. mt x pallet	cat.	prezzo (€)
4891102	2550141620050	16x2	6	MT	50	750	05	2,21
4891103	2550141620100	16x2	6	MT	100	1100	05	2,21
4891104	2550141820050	18x2	6	MT	50	800	05	3,07
4891109	2550142120050	20x2	6	MT	50	750	05	3,14
4891105	2550142020050	20x2	10	MT	50	550	05	3,42
4891110	2550142525025	25x2,5	10	MT	25	275	05	6,27
4891106	2550142630025	26x3	10	MT	25	375	05	6,59
4891107	2550142630050	26x3	10	MT	50	400	05	6,59
4891108	2550143230025	32x3	10	MT	25	250	05	9,86

TUBO PREISOLATO IN ROTOLI COLORE ROSSO

Per uso sanitario e riscaldamento.
Spessore isolamento conforme alla legge 10/91 ad esclusione dell'articolo 4892107.



codice	sigla	d _e x e (mm)	S-iso (mm)	UM	rotolo min.ord.	conf. mt x pallet	cat.	prezzo (€)
4892102	2560101620050	16x2	6	MT	50	750	05	2,21
4892108	2560101620100	16x2	6	MT	100	1100	05	2,21
4892104	2560101820050	18x2	6	MT	50	800	05	3,07
4892107	2560102120050	20x2	6	MT	50	750	05	3,14
4892103	2560102020050	20x2	10	MT	50	550	05	3,42
4892110	2560102525025	25x2,5	10	MT	25	275	05	6,27
4892105	2560102630025	26x3	10	MT	25	375	05	6,59
4892106	2560102630050	26x3	10	MT	50	400	05	6,59
4892109	2560103230025	32x3	10	MT	25	250	05	9,86

LEGENDA

d_e = diametro esterno

e = spessore tubo

S-iso = spessore isolamento

TUBO MULTISTRATO ACQUA

TUBO PREISOLATO IN ROTOLI COLORE VERDE

Per condizionamento e refrigerazione.
Spessore isolamento
conforme alla legge 10/91



NOVITÀ!

TUBO PREISOLATO IN ROTOLI COLORE BIANCO

Per uso sanitario e riscaldamento.
Spessore isolamento
conforme alla legge 10/91
ad esclusione
dell'articolo 4892607



NOVITÀ!

codice	sigla	d. x e (mm)	S-iso (mm)	UM	rotolo min.ord.	conf. mt x pallet	cat.	prezzo (€)
4891501	2580021620050	16x2	10	MT	50	500	05	2,88
4891502	2580021820050	18x2	13	MT	50	450	05	4,13
4891503	2580022020050	20x2	13	MT	50	400	05	4,32
4891504	2580022630025	26x3	13	MT	25	250	05	7,46
4891505	2580023230025	32x3	13	MT	25	250	05	11,39

codice	sigla	d. x e (mm)	S-iso (mm)	UM	rotolo min.ord.	conf. mt x pallet	cat.	prezzo (€)
4892602	2500061620050	16x2	6	MT	50	750	05	2,21
4892608	2500061620100	16x2	6	MT	100	1100	05	2,21
4892604	2500061820050	18x2	6	MT	50	800	05	3,10
4892607	2500062020050	20x2	6	MT	50	750	05	3,14
4892603	2500072020050	20x2	10	MT	50	550	05	3,42
4892605	2500062630050	26x3	10	MT	50	400	05	6,59
4892609	2500063230025	32x3	10	MT	25	250	05	9,86

RACCORDI IN OTTONE A PRESSARE PER MULTISTRATO ACQUA

Sistema di raccordi in ottone a pressare con 2 OR di tenuta idraulica in EPDM perossidico.
Utilizzabili con diversi profili di pinzatura:

Profilo ganascia	Ø 16	Ø 20	Ø 26	Ø 32	Ø 40	Ø 50	Ø 63
TH	X	X	X	X	X	X	X
H	X	X	X	X	X		
U	X	X		X	X	X	X



MANICOTTO



codice	sigla	Ø	UM	min. ord.	conf.	cat.	prezzo (€)
4894001	4001160000001	16	NR	5	40	05	5,15
4894002	4001200000001	20	NR	5	40	05	7,30
4894003	4001260000001	26	NR	5	20	05	9,15
4894004	4001320000001	32	NR	5	15	05	13,63
4894005	4001400000001	40	NR	1	8	05	33,31
4894006	4001500000001	50	NR	1	4	05	53,92
4894007	4001630000001	63	NR	1	12	05	103,14

MANICOTTO DI RIDUZIONE



codice	sigla	Ø	UM	min. ord.	conf.	cat.	prezzo (€)
4894101	4002201600001	20x16	NR	5	40	05	7,90
4894102	4002261600001	26x16	NR	5	30	05	7,90
4894103	4002262000001	26x20	NR	5	30	05	8,26
4894104	4002322000001	32x20	NR	5	20	05	11,07
4894105	4002322600001	32x26	NR	5	15	05	12,13
4894108	4002402600001	40x26	NR	1	10	05	29,89
4894109	4002403200001	40x32	NR	1	10	05	29,89
4894106	4002503200001	50x32	NR	1	6	05	44,19
4894107	4002504000001	50x40	NR	1	4	05	52,96
4894110	4002634000001	63x40	NR	1	12	05	101,44
4894111	4002635000001	63x50	NR	1	1	05	101,44

RACCORDO MASCHIO



codice	sigla	Ø	UM	min. ord.	conf.	cat.	prezzo (€)
4894202	4003160002001	16x1/2"	NR	5	40	05	4,13
4894203	4003200002001	20x1/2"	NR	5	40	05	4,83
4894204	4003200003001	20x3/4"	NR	5	35	05	5,98
4894205	4003260003001	26x3/4"	NR	5	30	05	7,49
4894206	4003260004001	26x1"	NR	5	20	05	10,11
4894207	4003320004001	32x1"	NR	5	20	05	11,04
4894208	4003400005001	40x1"1/4	NR	1	12	05	31,74
4894209	4003500006001	50x1"1/2	NR	1	8	05	48,74
4894210	4003630007001	63x2"	NR	1	16	05	93,79

RACCORDO FEMMINA



codice	sigla	Ø	UM	min. ord.	conf.	cat.	prezzo (€)
4894301	4004160002001	16x1/2"	NR	5	40	05	4,29
4894302	4004200002001	20x1/2"	NR	5	40	05	4,90
4894303	4004200003001	20x3/4"	NR	5	30	05	6,94
4894304	4004260003001	26x3/4"	NR	5	30	05	7,52
4894305	4004260004001	26x1"	NR	5	15	05	9,18
4894306	4004320004001	32x1"	NR	5	15	05	11,17
4894307	4004400005001	40x1"1/4	NR	1	10	05	32,06
4894308	4004500006001	50x1"1/2	NR	1	8	05	51,55

MULTISTRATO

RACCORDI IN OTTONE A PRESSARE PER MULTISTRATO ACQUA

GOMITO A 90°



codice	sigla	Ø	UM	min. ord.	conf.	cat.	prezzo (€)
4894501	4006160000001	16	NR	5	30	05	5,82
4894502	4006200000001	20	NR	5	30	05	8,00
4894503	4006260000001	26	NR	5	15	05	12,19
4894504	4006320000001	32	NR	5	10	05	18,46
4894505	4006400000001	40	NR	1	6	05	38,85
4894506	4006500000001	50	NR	1	2	05	70,05
4894507	4006630000001	63	NR	1	8	05	106,78

GOMITO A 90° CON DERIVAZIONE FEMMINA



codice	sigla	Ø	UM	min. ord.	conf.	cat.	prezzo (€)
4894801	4009160002001	16x1/2"	NR	5	30	05	5,31
4894802	4009200002001	20x1/2"	NR	5	30	05	6,34
4894803	4009200003001	20x3/4"	NR	5	25	05	8,35
4894804	4009260003001	26x3/4"	NR	5	20	05	11,46
4894805	4009320004001	32x1"	NR	5	10	05	18,02
4894806	4009400005001	40x1"1/4	NR	1	6	05	40,67
4894807	4009500006001	50x1"1/2	NR	1	3	05	73,31

GOMITO A 90° CON DERIVAZIONE MASCHIO



codice	sigla	Ø	UM	min. ord.	conf.	cat.	prezzo (€)
4894701	4008160002001	16x1/2"	NR	5	40	05	5,15
4894702	4008200002001	20x1/2"	NR	5	30	05	6,56
4894703	4008200003001	20x3/4"	NR	5	25	05	7,62
4894704	4008260003001	26x3/4"	NR	5	20	05	10,43
4894705	4008320004001	32x1"	NR	5	10	05	18,82
4894706	4008400005001	40x1"1/4	NR	1	8	05	39,33
4894707	4008500006001	50x1"1/2	NR	1	4	05	70,78
4894708	4008630007001	63x2"	NR	1	10	05	106,98

GOMITO A 45°



codice	sigla	Ø	UM	min. ord.	conf.	cat.	prezzo (€)
4897001	4011260000001	26	NR	1	1	05	18,66
4897002	4011320000001	32	NR	1	1	05	21,50
4897003	4011400000001	40	NR	1	1	05	75,04

TEE A 90° RIDOTTO



codice	sigla	Ø	UM	min. ord.	conf.	cat.	prezzo (€)
4895001	4013201616001	20x16x16	NR	2	16	05	9,86
4895002	4013201620001	20x16x20	NR	2	16	05	10,40
4895003	4013202016001	20x20x16	NR	2	16	05	10,66
4895018	4013261620001	26x16x20	NR	2	12	05	13,86
4895004	4013261626001	26x16x26	NR	2	12	05	16,64
4895005	4013262020001	26x20x20	NR	2	12	05	15,55
4895006	4013262026001	26x20x26	NR	2	12	05	16,93
4895019	4013262616001	26x26x16	NR	2	12	05	16,03
4895020	4013262620001	26x26x20	NR	2	12	05	16,42
4895007	4013322032001	32x20x32	NR	2	8	05	23,55
4895008	4013322626001	32x26x26	NR	2	8	05	26,40
4895009	4013322632001	32x26x32	NR	2	8	05	27,84
4895012	4013402640001	40x26x40	NR	1	4	05	58,69
4895013	4013403232001	40x32x32	NR	1	5	05	55,39
4895014	4013403240001	40x32x40	NR	1	4	05	58,82
4895015	4013502650001	50x26x50	NR	1	8	05	113,98
4895016	4013503250001	50x32x50	NR	1	8	05	113,98
4895017	4013504050001	50x40x50	NR	1	8	05	113,98
4895021	4013633263001	63x32x63	NR	1	1	05	124,13
4895022	4013634063001	63x40x63	NR	1	1	05	124,13
4895023	4013635063001	63x50x63	NR	1	4	05	180,64

TEE A 90°



codice	sigla	Ø	UM	min. ord.	conf.	cat.	prezzo (€)
4894401	4005160000001	16	NR	2	20	05	8,38
4894402	4005200000001	20	NR	2	16	05	10,94
4894403	4005260000001	26	NR	2	10	05	17,63
4894404	4005320000001	32	NR	2	8	05	28,10
4894405	4005400000001	40	NR	1	4	05	59,23
4894406	4005500000001	50	NR	1	7	05	104,16
4894407	4005630000001	63	NR	1	4	05	177,25

RACCORDI IN OTTONE A PRESSARE PER MULTISTRATO ACQUA

TEE A 90° CON DERIVAZIONE FEMMINA



codice	sigla	∅	UM	min. ord.	conf.	cat.	prezzo (€)
4894601	4007160002001	16x1/2"x16	NR	2	20	05	8,16
4894602	4007200002001	20x1/2"x20	NR	2	16	05	10,91
4894603	4007200003001	20x3/4"x20	NR	2	16	05	11,94
4894604	4007260003001	26x3/4"x26	NR	2	12	05	17,95
4894605	4007320004001	32x1"x32	NR	2	8	05	28,61
4894606	4007400005001	40x1"1/4x40	NR	1	12	05	59,90
4894607	4007500006001	50x1"1/2x50	NR	1	12	05	107,78
4894608	4007630005001	63x1"1/4x63	NR	1	8	05	146,53

TEE A 90° CON DERIVAZIONE MAGGIORATA



codice	sigla	∅	UM	min. ord.	conf.	cat.	prezzo (€)
4897101	4029162016001	16x20x16	NR	2	16	05	13,63
4897102	4029202620001	20x26x20	NR	2	12	05	20,61

RACCORDO MURALE A GOMITO



codice	sigla	∅	h (mm)	UM	min. ord.	conf.	cat.	prezzo (€)
4895400	4034160102001	16x1/2"	36	NR	5	15	05	11,23
4895401	4034160002001	16x1/2"	53	NR	5	15	05	11,46
4895404	4034200102001	20x1/2"	36	NR	5	15	05	12,00
4895402	4034200002001	20x1/2"	53	NR	5	15	05	12,38

RACCORDO DIRITTO FEMMINA CON DADO GIREVOLE



codice	sigla	∅	UM	min. ord.	conf.	cat.	prezzo (€)
4895101	4014160002001	16x1/2"	NR	1	40	05	4,90
4895103	4014200002001	20x1/2"	NR	1	40	05	5,31
4895104	4014200003001	20x3/4"	NR	1	40	05	5,73
4895105	4014260003001	26x3/4"	NR	1	30	05	9,50

RUBINETTO CON ROSONE



codice	sigla	∅	UM	min. ord.	conf.	cat.	prezzo (€)
4895301	4016161600001	16	NR	1	6	05	62,82
4895302	4016202000001	20	NR	1	6	05	64,13

MULTISTRATO

RACCORDI A COMPRESSIONE PER MULTISTRATO ACQUA

Conforme alle norme UNI EN 1254-3, UNI EN 21003-3

Raccordo in ottone CW617N-DW con filettatura realizzata secondo la norma UNI EN 10226-1, O-ring in EPDM nero conformi alla norma UNI EN 681-1, idoneo per il trasporto di acque destinate al consumo umano (potabili).

Per impianti di riscaldamento, circuito sanitario, aria compressa, acqua refrigerata.

Per tubi multistrato dalle seguenti caratteristiche:

Ø (mm)	spessore (mm)
16	2
20	2
26	3
32	3



MANICOTTO F/F



codice	sigla	Ø	UM	min. ord. conf.	cat.	prezzo (€)
6550001	C301 016000000	16	NR	10	10	6,80
6550002	C301 020000000	20	NR	10	10	10,50
6550003	C301 026000000	26	NR	5	10	16,74
6550004	C301 032000000	32	NR	5	10	27,94

MANICOTTO F/FILETTO F



codice	sigla	Ø	UM	min. ord. conf.	cat.	prezzo (€)
6552008	C303 016004000	16x1/2"	NR	10	10	4,20
6552010	C303 020004000	20x1/2"	NR	10	10	6,13
6552011	C303 020006000	20x3/4"	NR	10	10	6,94
6552012	C303 026006000	26x3/4"	NR	5	10	10,72
6552013	C303 026008000	26x1"	NR	5	10	12,04
6552014	C303 032008000	32x1"	NR	5	10	17,42

MANICOTTO F/FILETTO M



codice	sigla	Ø	UM	min. ord. conf.	cat.	prezzo (€)
6552001	C302 016004000	16x1/2"	NR	10	10	3,56
6552003	C302 020004000	20x1/2"	NR	10	10	5,96
6552004	C302 020006000	20x3/4"	NR	10	10	6,22
6552005	C302 026006000	26x3/4"	NR	5	10	10,78
6552006	C302 026008000	26x1"	NR	5	10	12,10
6552007	C302 032008000	32x1"	NR	5	10	18,48

GOMITO A 90° F/FILETTO M



codice	sigla	Ø	UM	min. ord. conf.	cat.	prezzo (€)
6554001	C402 016004000	16x1/2"	NR	10	10	5,35
6554003	C402 020004000	20x1/2"	NR	10	10	7,56
6554004	C402 020006000	20x3/4"	NR	10	10	7,87
6554005	C402 026006000	26x3/4"	NR	5	10	13,24
6554006	C402 032008000	32x1"	NR	5	10	21,28

GOMITO A 90° F/F



codice	sigla	Ø	UM	min. ord. conf.	cat.	prezzo (€)
6553001	C401 016000000	16	NR	10	10	7,81
6553002	C401 020000000	20	NR	10	10	11,51
6553003	C401 026000000	26	NR	5	10	17,98
6553004	C401 032000000	32	NR	5	10	29,90

GOMITO A 90° F/FILETTO F



codice	sigla	Ø	UM	min. ord. conf.	cat.	prezzo (€)
6555001	C403 016004000	16x1/2"	NR	10	10	5,26
6555003	C403 020004000	20x1/2"	NR	10	10	7,95
6555004	C403 020006000	20x3/4"	NR	10	10	8,29
6555005	C403 026006000	26x3/4"	NR	5	10	13,05
6555006	C403 026008000	26x1"	NR	5	10	16,02
6555007	C403 032008000	32x1"	NR	5	10	22,68

RACCORDI A COMPRESSIONE PER MULTISTRATO ACQUA

GOMITO A 90° F/FILETTO F CON FLANGIA A 2 FORI DI FISSAGGIO



codice	sigla	Ø	UM	min. ord. conf.	cat.	prezzo (€)
6556001	C403L016004000	16x1/2"	NR	10	10	6,72
6556003	C403L020004000	20x1/2"	NR	5	10	9,35

TEE F/FILETTO F/F



codice	sigla	Ø	UM	min. ord. conf.	cat.	prezzo (€)
6559001	C617 016004000	16x1/2"x16	NR	10	10	8,99
6559003	C617 020004000	20x1/2"x20	NR	5	10	13,22
6559004	C617 020006000	20x3/4"x20	NR	5	10	13,24

TEE F/F/F



codice	sigla	Ø	UM	min. ord. conf.	cat.	prezzo (€)
6557001	C601 016000000	16	NR	10	10	10,44
6557002	C601 020000000	20	NR	5	10	16,21
6557003	C601 026000000	26	NR	5	10	27,16
6557004	C601 032000000	32	NR	5	10	45,30

COLLETTORI E DIME

RACCORDO CON CALOTTA PER TUBO MULTISTRATO



codice	sigla	Ø	UM	min. ord. conf.	cat.	prezzo (€)
4895801	4097162002001	16x2"x1/2"	NR	1	50 05	4,93

COLLETTORE A 2 DERIVAZIONI

Con valvole di regolazione



codice	sigla	Ø	UM	min. ord. conf.	cat.	prezzo (€)
4896401	4098020203001	3/4"x1/2"	NR	1	05	34,78

COLLETTORE A 3 DERIVAZIONI

Con valvole di regolazione



codice	sigla	Ø	UM	min. ord. conf.	cat.	prezzo (€)
4898501	4098030203001	3/4"x1/2"	NR	1	05	51,52

COLLETTORE A 4 DERIVAZIONI

Con valvole di regolazione



codice	sigla	Ø	UM	min. ord. conf.	cat.	prezzo (€)
4898601	4098040203001	3/4"x1/2"	NR	1	05	69,25

DIMA DI FISSAGGIO



codice	sigla	descrizione	UM	min. ord. conf.	cat.	prezzo (€)
4895601	4017000000001	semplice	NR	1	05	6,85
4895701	4018000000001	angolata multipla	NR	1	05	11,39

RACCORDERIA IN OTTONE

RACCORDERIA CROMATA FILETTATURA CILINDRICA

Conforme alla normativa vigente per il tipo di lega:

- UNI EN 12165:11 CW617N per i particolari stampati
- UNI EN 12164:11 CW614N e UNI EN 12168:11 CW617N per i particolari da barra

Filettatura:

UNI ISO 228/1

GOMITO FEMMINA-FEMMINA



codice	sigla	Ø	UM	min. ord. conf.	cat.	prezzo (€)
● 2735021	00560300CR	3/8"	NR	10	06	5,33
● 2735022	00560400CR	1/2"	NR	10	06	5,76

GOMITO MASCHIO-FEMMINA



codice	sigla	Ø	UM	min. ord. conf.	cat.	prezzo (€)
● 2735011	00550300CR	3/8"	NR	10	06	5,11
● 2735012	00550400CR	1/2"	NR	10	06	5,76

TEE



codice	sigla	Ø	UM	min. ord. conf.	cat.	prezzo (€)
● 2735001	00540300CR	3/8"	NR	10	06	6,23
● 2735002	00540400CR	1/2"	NR	10	06	6,44

MANICOTTO



codice	sigla	Ø	UM	min. ord. conf.	cat.	prezzo (€)
● 2735111	00530300CR	3/8"	NR	10	06	2,88
● 2735112	00530400CR	1/2"	NR	10	06	4,00

RIDUZIONE



codice	sigla	Ø	UM	min. ord. conf.	cat.	prezzo (€)
● 2735132	06780430CR	1/2" M x 3/8" F	NR	10	06	1,76
● 2735133	06780540CR	3/4" M x 1/2" F	NR	10	06	2,45

NIPPLE



codice	sigla	Ø	UM	min. ord. conf.	cat.	prezzo (€)
● 2750223	00390300CR	3/8" x 3/8"	NR	10	06	2,45
● 2750224	0039R340CR	3/8" x 1/2"	NR	10	06	2,66
● 2750225	00390400CR	1/2" x 1/2"	NR	10	06	2,66
● 2750226	0039R450CR	1/2" x 3/4"	NR	10	06	3,56
● 2750227	00390500CR	3/4" x 3/4"	NR	10	06	3,56

PROLUNGA RIDOTTA



codice	sigla	Ø	lung. (mm)	UM	min. ord. conf.	cat.	prezzo (€)
● 2735091	00520340CR	3/8" M x 1/2" F	14,5	NR	10	06	2,66
● 2735092	00520450CR	1/2" M x 3/4" F	15	NR	10	06	4,46

PROLUNGA



codice	sigla	Ø	lung. (mm)	UM	min. ord. conf.	cat.	prezzo (€)
● 2735060	00513010CR	3/8"	10	NR	10	06	2,02
● 2735061	00513015CR	3/8"	15	NR	10	06	2,23
● 2735062	00513020CR	3/8"	20	NR	10	06	2,45
● 2735063	00513030CR	3/8"	30	NR	10	06	3,35
● 2735051	00514010CR	1/2"	10	NR	10	06	2,88
● 2735052	00514015CR	1/2"	15	NR	10	06	3,56
● 2735053	00514020CR	1/2"	20	NR	10	06	4,00
● 2735054	00514030CR	1/2"	30	NR	10	06	5,11
● 2735055	00514040CR	1/2"	40	NR	10	06	6,23
● 2735056	00514050CR	1/2"	50	NR	10	06	7,31
● 2735057	00514060CR	1/2"	60	NR	10	06	8,89
● 2735059	00514100CR	1/2"	100	NR	10	06	15,08
● 2735069	00515010CR	3/4"	10	NR	10	06	3,35
● 2735070	00515015CR	3/4"	15	NR	10	06	4,00
● 2735071	00515020CR	3/4"	20	NR	10	06	4,64

RACCORDERIA IN OTTONE

RACCORDERIA CROMATA FILETTATURA CILINDRICA

TAPPO FEMMINA



codice	sigla	Ø	UM	min. ord. conf.	cat.	prezzo (€)
● 2735181	06720300CR	3/8"	NR	10	06	1,76
● 2735182	06720400CR	1/2"	NR	10	06	2,02
● 2735183	06720500CR	3/4"	NR	10	06	3,35

TAPPO MASCHIO



codice	sigla	Ø	UM	min. ord. conf.	cat.	prezzo (€)
● 2735141	06710300CR	3/8"	NR	10	06	1,76
● 2735142	06710400CR	1/2"	NR	10	06	2,02
● 2735143	06710500CR	3/4"	NR	10	06	3,56

BICONI CROMATI

BICONO MASCHIO



codice	sigla	Ø	filetto (mm)	UM	min. ord. conf.	cat.	prezzo (€)
● 2750240	0321B330CR	3/8"x10	13	NR	10	06	3,35
● 2750241	0320B330CR	3/8" x10	20	NR	10	06	4,00
● 2750242	0320B342CR	3/8" x12	20	NR	10	06	4,64
● 2750244	0321B430CR	1/2" x10	13	NR	10	06	3,35
● 2750245	0320B430CR	1/2" x10	20	NR	10	06	4,00
● 2750246	0320B442CR	1/2" x12	20	NR	10	06	4,64
● 2750247	0320B444CR	1/2" x14	20	NR	10	06	4,64

BICONO FEMMINA



codice	sigla	attacco Ø	calotta Ø	UM	min. ord. conf.	cat.	prezzo (€)
● 2750311	0041B330CR	3/8"	3/8"x10	NR	10	06	3,56
● 2750313	0041B430CR	1/2"	3/8"x10	NR	10	06	4,46
● 2750314	0041B440CR	1/2"	1/2"x10	NR	10	06	4,46
● 2750315	0041B442CR	1/2"	1/2"x12	NR	10	06	4,86
● 2750316	0041B444CR	1/2"	1/2"x14	NR	10	06	4,46

BICONO DOPPIO



codice	sigla	calotta Ø	UM	min. ord. conf.	cat.	prezzo (€)
● 2750301	0040B310CR	3/8"x10	NR	10	06	4,86

BICONO DOPPIO A GOMITO



codice	sigla	calotta Ø	UM	min. ord. conf.	cat.	prezzo (€)
● 2750321	0042B310CR	3/8"x10	NR	10	06	7,31

BICONO MASCHIO PROLUNGATO CON ROSONE



codice	sigla	attacco Ø	calotta Ø	UM	min. ord. conf.	cat.	prezzo (€)
● 2750251	0330C330CR	3/8"	3/8"x10	NR	2	06	4,86
● 2750252	0330C430CR	1/2"	3/8"x10	NR	2	06	4,86

NIPPLE RIDOTTO PROLUNGATO CON ROSONE



codice	sigla	Ø	UM	min. ord. conf.	cat.	prezzo (€)
● 2750263	0330R430CR	1/2"x3/8"	NR	2	06	4,21

NIPPLE RIDOTTO PROLUNGATO SENZA ROSONE



codice	sigla	Ø	UM	min. ord. conf.	cat.	prezzo (€)
● 2750264	03300430CR	1/2"x3/8"	NR	2	06	4,00
● 2750266	03300442CR	1/2"x1/2"	NR	2	06	4,00

PROLUNGA PER RETROGRUPPO CALOTTA GIREVOLE

Lunghezza 40 mm



codice	sigla	attacco Ø	foro Ø	UM	min. ord. conf.	cat.	prezzo (€)
● 2751122	00630530CR	3/4"M x 3/4"F	3/8"	NR	1	06	10,94
● 2751123	0063F540CR	3/4"M x 3/4"F	1/2"	NR	1	06	13,50
● 2751121	00620500CR	3/4"M x 3/4"F	-	NR	1	06	11,16

PROLUNGA CON E SENZA CALOTTA

Lunghezza 40 mm



codice	sigla	attacco Ø	calotta Ø	UM	min. ord. conf.	cat.	prezzo (€)
● 2735041	0050B340CR	3/8"	3/8"x10	NR	10	06	4,46
● 2735031	00500340CR	3/8"	-	NR	10	06	3,13

RACCORDERIA IN OTTONE

RACCORDERIA CROMATA FILETTATURA CONICA

Conforme alla normativa vigente per il tipo di lega:

- UNI EN 12165 per i particolari stampati.
- UNI EN 12164 per i particolari da barra.
- Contenuto di piombo pari al 1,8% inferiore al limite ammesso dalla Direttiva Europea 98/83/CE (3,5%).

Filettatura:

UNI EN 10226-1 per l'accoppiamento a tenuta sul filetto: idonei per applicazioni con acqua calda e fredda, impianti di riscaldamento e di miscele acqua/glicole max. fino al 50%, per installazioni di solare termico, raffrescamento, aria compressa, gas combustibili, gas refrigeranti, settori industriale e navale meccanico.

GOMITO A 90° F/F



codice	sigla	Ø	UM	min. ord. conf.	cat.	prezzo (€)
1601000	8090 002C00000	1/4"	NR	10	01	3,86
1601001	8090 003C00000	3/8"	NR	10	01	4,95
1601002	8090 004C00000	1/2"	NR	10	01	5,61
1601003	8090 006C00000	3/4"	NR	10	01	9,27
1601004	8090 008C00000	1"	NR	10	01	14,59

GOMITO A 90° M/F



codice	sigla	Ø	UM	min. ord. conf.	cat.	prezzo (€)
1602000	8092 002C00000	1/4"	NR	10	01	4,03
1602001	8092 003C00000	3/8"	NR	10	01	4,72
1602002	8092 004C00000	1/2"	NR	10	01	5,38
1602003	8092 006C00000	3/4"	NR	10	01	9,14
1602004	8092 008C00000	1"	NR	10	01	14,29

TEE F/F/F



codice	sigla	Ø	UM	min. ord. conf.	cat.	prezzo (€)
1603000	8130 002C02002	1/4"	NR	10	01	4,55
1603001	8130 003C03003	3/8"	NR	10	01	5,71
1603002	8130 004C04004	1/2"	NR	10	01	6,47
1603003	8130 006C06006	3/4"	NR	10	01	10,82
1603004	8130 008C08008	1"	NR	5	01	16,43

MANICOTTO F/F



codice	sigla	Ø	UM	min. ord. conf.	cat.	prezzo (€)
1604005	8270 002C00000	1/4"	NR	10	01	2,77
1604001	8270 003C00000	3/8"	NR	10	01	2,77
1604002	8270 004C00000	1/2"	NR	10	01	3,63
1604003	8270 006C00000	3/4"	NR	10	01	4,65
1604004	8270 008C00000	1"	NR	10	01	8,25

MANICOTTO RIDOTTO F/F



codice	sigla	Ø	UM	min. ord. conf.	cat.	prezzo (€)
1614001	8240 006004C00	3/4"x1/2"	NR	10	01	5,45
1614002	8240 008004C00	1"x1/2"	NR	10	01	8,42
1614103	8240 008006C00	1"x3/4"	NR	10	01	9,21

NIPPLO M/M



codice	sigla	Ø	UM	min. ord. conf.	cat.	prezzo (€)
1605000	8280 002C00000	1/4"	NR	10	01	1,72
1605001	8280 003C00000	3/8"	NR	10	01	1,88
1605002	8280 004C00000	1/2"	NR	10	01	2,44
1605003	8280 006C00000	3/4"	NR	10	01	3,99
1605004	8280 008C00000	1"	NR	10	01	6,96

RACCORDERIA IN OTTONE

RACCORDERIA CROMATA FILETTATURA CONICA

NIPPLA RIDOTTO M/M



codice	sigla	Ø	UM	min. ord. conf.	cat.	prezzo (€)
1606000	8245 002001C00	1/4"x1/8"	NR	10	01	1,58
1606003	8245 003002C00	3/8"x1/4"	NR	10	01	1,98
1606005	8245 004002C00	1/2"x1/4"	NR	10	01	3,00
1606001	8245 004003C00	1/2"x3/8"	NR	10	01	2,44
1606006	8245 006003C00	3/4"x3/8"	NR	10	01	3,86
1606002	8245 006004C00	3/4"x1/2"	NR	10	01	3,96
1606007	8245 008004C00	1"x1/2"	NR	10	01	6,57
1606004	8245 008006C00	1"x3/4"	NR	10	01	6,77

RIDUZIONE M/F ESAGONALE



codice	sigla	Ø	UM	min. ord. conf.	cat.	prezzo (€)
1607000	8241 002001C00	1/4"x1/8"	NR	10	01	1,16
1607006	8241 003001C00	3/8"x1/8"	NR	10	01	1,58
1607007	8241 003002C00	3/8"x1/4"	NR	10	01	1,42
1607008	8241 004002C00	1/2"x1/4"	NR	10	01	2,48
1607001	8241 004003C00	1/2"x3/8"	NR	10	01	1,75
1607009	8241 006002C00	3/4"x1/4"	NR	10	01	3,89
1607010	8241 006003C00	3/4"x3/8"	NR	10	01	3,33
1607002	8241 006004C00	3/4"x1/2"	NR	10	01	2,81
1607011	8241 008003C00	1"x3/8"	NR	10	01	6,30
1607012	8241 008004C00	1"x1/2"	NR	10	01	5,74
1607003	8241 008006C00	1"x3/4"	NR	10	01	4,95

PROLUNGA M/F, CON FILETTO CILINDRICO



codice	sigla	Ø	lung. mm	UM	min. ord. conf.	cat.	prezzo (€)
1609007	8540 003010C00	3/8"	10	NR	10	01	2,21
1609000	8540 003015C00	3/8"	15	NR	10	01	2,61
1609009	8540 003020C00	3/8"	20	NR	10	01	2,97
1609015	8540 003025C00	3/8"	25	NR	10	01	3,89
1609016	8540 003030C00	3/8"	30	NR	10	01	4,39
1609017	8540 003040C00	3/8"	40	NR	10	01	5,05
1609018	8540 003050C00	3/8"	50	NR	10	01	6,63
1609001	8540 004010C00	1/2"	10	NR	10	01	2,71
1609002	8540 004015C00	1/2"	15	NR	10	01	3,20
1609003	8540 004020C00	1/2"	20	NR	10	01	3,73
1609019	8540 004025C00	1/2"	25	NR	10	01	4,59
1609004	8540 004030C00	1/2"	30	NR	10	01	5,08
1609005	8540 004040C00	1/2"	40	NR	10	01	6,20
1609006	8540 004050C00	1/2"	50	NR	10	01	8,32
1609010	8540 004060C00	1/2"	60	NR	10	01	10,43
1609021	8540 004070C00	1/2"	70	NR	10	01	11,48
1609022	8540 004080C00	1/2"	80	NR	10	01	13,00
1609012	8540 004100C00	1/2"	100	NR	10	01	17,13
1609024	8540 006010C00	3/4"	10	NR	10	01	3,70
1609025	8540 006015C00	3/4"	15	NR	10	01	5,08
1609026	8540 006020C00	3/4"	20	NR	10	01	5,71
1609027	8540 006025C00	3/4"	25	NR	10	01	6,80
1609028	8540 006030C00	3/4"	30	NR	10	01	7,72
1609029	8540 006040C00	3/4"	40	NR	10	01	9,83
1609030	8540 006050C00	3/4"	50	NR	10	01	11,29

TAPPO M, CON FILETTO CILINDRICO



codice	sigla	Ø	UM	min. ord. conf.	cat.	prezzo (€)
1612000	8292 002C00000	1/4"	NR	10	01	1,52
1612001	8292 003C00000	3/8"	NR	10	01	1,95
1612002	8292 004C00000	1/2"	NR	10	01	2,71
1612003	8292 006C00000	3/4"	NR	10	01	4,09
1612004	8292 008C00000	1"	NR	10	01	6,27

TAPPO F



codice	sigla	Ø	UM	min. ord. conf.	cat.	prezzo (€)
1611004	8300 002C00000	1/4"	NR	10	01	1,22
1611000	8300 003C00000	3/8"	NR	10	01	1,58
1611001	8300 004C00000	1/2"	NR	10	01	1,88
1611002	8300 006C00000	3/4"	NR	10	01	2,87
1611003	8300 008C00000	1"	NR	10	01	3,86

RIDUZIONE F/M, CON FILETTO CILINDRICO



codice	sigla	Ø	UM	min. ord. conf.	cat.	prezzo (€)
1608001	8243 004003C00	1/2"x3/8"	NR	10	01	3,86
1608002	8243 006004C00	3/4"x1/2"	NR	10	01	4,75
1608008	8243 008006C00	1"x3/4"	NR	10	01	7,49

RACCORDERIA IN OTTONE

RACCORDERIA IN OTTONE GIALLO FILETTATURA CONICA

Conforme alla normativa vigente per il tipo di lega:

- UNI EN 12165 per i particolari stampati.
- UNI EN 12164 per i particolari da barra.
- Contenuto di piombo inferiore al limite ammesso dalla Direttiva Europea 98/83/CE.

Filettatura:

UNI EN 10226-1 per l'accoppiamento a tenuta sul filetto: idonei per applicazioni con acqua calda e fredda, impianti di riscaldamento e di miscele acqua/glicole max. fino al 50%, per installazioni di solare termico, raffrescamento, aria compressa, gas combustibili, gas refrigeranti e settori industriale e navale meccanico.

Tutti gli elementi elastomerici sono in EPDM nero conformi alla norma UNI EN 681-1: idonei per il trasporto di acque destinate al consumo umano (potabili)

GOMITO A 90° F/F



codice	sigla	Ø	UM	min. ord. conf.	cat.	prezzo (€)
1502000	8090 002000000	1/4"	NR	10	01	2,74
1502004	8090 003000000	3/8"	NR	10	01	3,50
1502001	8090 004000000	1/2"	NR	10	04	3,69
1502002	8090 006000000	3/4"	NR	10	04	6,20
1502003	8090 008000000	1"	NR	5	04	10,08
1501004	8090 010000000	1"1/4	NR	5	01	18,32
1501005	8090 012000000	1"1/2	NR	5	01	25,08
1501006	8090 016000000	2"	NR	2	01	41,78
1501107	8090 020000000	2"1/2	NR	1	01	91,01

GOMITO A 90° RIDOTTO F/F



codice	sigla	Ø	UM	min. ord. conf.	cat.	prezzo (€)
1503004	8090R004003000	1/2"x3/8"	NR	10	01	5,15
1503001	8090R006004000	3/4"x1/2"	NR	10	01	7,72
1503003	8090R008006000	1"x3/4"	NR	5	01	11,35

TEE F/F/F



codice	sigla	Ø	UM	min. ord. conf.	cat.	prezzo (€)
1513000	8130 002002002	1/4"	NR	10	01	3,14
1513004	8130 003003003	3/8"	NR	10	01	4,09
1513001	8130 004004004	1/2"	NR	10	04	5,15
1513002	8130 006006006	3/4"	NR	10	04	7,94
1513003	8130 008008008	1"	NR	5	04	12,37
1512004	8130 010010010	1"1/4	NR	5	01	24,52
1512005	8130 012012012	1"1/2	NR	1	01	30,53
1512006	8130 016016016	2"	NR	1	01	47,95
1512107	8130 020020020	2"1/2	NR	1	01	120,85

GOMITO A 90° M/F



codice	sigla	Ø	UM	min. ord. conf.	cat.	prezzo (€)
1505000	8092 002000000	1/4"	NR	10	01	2,51
1505004	8092 003000000	3/8"	NR	10	01	3,23
1505001	8092 004000000	1/2"	NR	10	04	3,75
1505002	8092 006000000	3/4"	NR	10	04	5,92
1505003	8092 008000000	1"	NR	10	04	9,77
1504004	8092 010000000	1"1/4	NR	5	01	19,31
1504005	8092 012000000	1"1/2	NR	2	01	24,16
1504006	8092 016000000	2"	NR	2	01	39,27
1504107	8092 020000000	2"1/2	NR	1	01	105,11

TEE RIDOTTO F/F/F



codice	sigla	Ø	UM	min. ord. conf.	cat.	prezzo (€)
1514000	8130R004003004	1/2"x3/8"x1/2"	NR	10	01	6,30
1514002	8130R006004004	3/4"x1/2"x1/2"	NR	10	01	9,87
1514001	8130R006004006	3/4"x1/2"x3/4"	NR	10	01	8,71
1514006	8130R006006004	3/4"x3/4"x1/2"	NR	10	01	11,12
1514003	8130R008004008	1"x1/2"x1"	NR	5	01	13,99
1514005	8130R008006008	1"x3/4"x1"	NR	5	01	18,35
1514009	8130R008008004	1"x1"x1/2"	NR	5	01	16,93
1514010	8130R010004010	1"1/4x1/2"x1"1/4	NR	1	01	20,79
1514011	8130R010006010	1"1/4x3/4"x1"1/4	NR	1	01	22,97
1514007	8130R010008010	1"1/4"x1"x1"1/4	NR	5	01	26,37
1514012	8130R012004012	1"1/2x1/2"x1"1/2	NR	1	01	28,05
1514013	8130R012006012	1"1/2x3/4"x1"1/2	NR	1	01	30,49
1514014	8130R012008012	1"1/2x1"x1"1/2	NR	1	01	36,47

RACCORDERIA IN OTTONE GIALLO FILETTATURA CONICA

CROCE F/F/F/F



codice	sigla	Ø	UM	min. ord. conf.	cat.	prezzo (€)
1515001	8180 004000000	1/2"	NR	10	01	9,87
1515002	8180 006000000	3/4"	NR	10	01	14,55
1515003	8180 008000000	1"	NR	5	01	21,78
1515104	8180 010000000	1"1/4	NR	1	01	35,48
1515105	8180 012000000	1"1/2	NR	1	01	55,21
1515106	8180 016000000	2"	NR	1	01	84,38

RIDUZIONE ESAGONALE M/F



codice	sigla	Ø	UM	min. ord. conf.	cat.	prezzo (€)
1525000	8241 002001000	1/4"x1/8"	NR	10	01	0,79
1525028	8241 003001000	3/8"x1/8"	NR	10	01	1,29
1525015	8241 003002000	3/8"x1/4"	NR	10	01	0,99
1525001	8241 004002000	1/2"x1/4"	NR	10	01	2,01
1525002	8241 004003000	1/2"x3/8"	NR	10	01	1,35
1525027	8241 006002000	3/4"x1/4"	NR	10	01	3,00
1525016	8241 006003000	3/4"x3/8"	NR	10	01	2,71
1525003	8241 006004000	3/4"x1/2"	NR	10	01	2,31
1525020	8241 008003000	1"x3/8"	NR	10	01	4,92
1525004	8241 008004000	1"x1/2"	NR	10	01	4,46
1525005	8241 008006000	1"x3/4"	NR	10	01	3,56
1525006	8241 010004000	1"1/4x1/2"	NR	5	01	8,75
1525007	8241 010006000	1"1/4x3/4"	NR	5	01	7,36
1525008	8241 010008000	1"1/4x1"	NR	5	01	5,94
1525021	8241 012004000	1"1/2x1/2"	NR	5	01	12,01
1525009	8241 012006000	1"1/2x3/4"	NR	5	01	10,86
1525010	8241 012008000	1"1/2x1"	NR	5	01	9,04
1525011	8241 012010000	1"1/2x1"1/4	NR	5	01	6,70
1525022	8241 016006000	2"x3/4"	NR	1	01	20,06
1525012	8241 016008000	2"x1"	NR	1	01	16,57
1525013	8241 016010000	2"x1"1/4	NR	1	01	15,51
1525014	8241 016012000	2"x1"1/2	NR	1	01	12,97
1525123	8241 020016000	2"1/2x2"	NR	1	01	27,19
1525024	8241 024016000	3"x2"	NR	1	01	40,29
1525025	8241 024020000	3"x2"1/2	NR	1	01	48,44

MANICOTTO F/F



codice	sigla	Ø	UM	min. ord. conf.	cat.	prezzo (€)
1516007	8270 002000000	1/4"	NR	10	01	2,18
1516008	8270 003000000	3/8"	NR	10	01	2,71
1516001	8270 004000000	1/2"	NR	10	01	3,47
1516002	8270 006000000	3/4"	NR	10	01	4,42
1516003	8270 008000000	1"	NR	10	01	7,36
1516004	8270 010000000	1"1/4	NR	10	01	11,65
1516005	8270 012000000	1"1/2	NR	5	01	14,65
1516006	8270 016000000	2"	NR	1	01	21,22

MANICOTTO RIDOTTO F/F



codice	sigla	Ø	UM	min. ord. conf.	cat.	prezzo (€)
1517001	8240 004003000	1/2"x3/8"	NR	10	01	2,84
1517002	8240 006004000	3/4"x1/2"	NR	10	01	3,99
1517003	8240 008004000	1"x1/2"	NR	10	01	6,11
1517004	8240 008006000	1"x3/4"	NR	10	01	7,00
1517011	8240 010006000	1"1/4x3/4"	NR	5	01	9,31
1517005	8240 010008000	1"1/4x1"	NR	5	01	9,93
1517007	8240 012010000	1"1/2x1"1/4	NR	1	01	15,87
1517009	8240 016012000	2"x1"1/2	NR	1	01	21,29

NIPLO M/M



codice	sigla	Ø	UM	min. ord. conf.	cat.	prezzo (€)
1518010	8280 002000000	1/4"	NR	10	01	1,25
1518011	8280 003000000	3/8"	NR	10	01	1,58
1519001	8280 004000000	1/2"	NR	10	04	1,98
1519002	8280 006000000	3/4"	NR	10	04	3,01
1519003	8280 008000000	1"	NR	10	04	4,99
1518004	8280 010000000	1"1/4	NR	10	01	8,25
1518005	8280 012000000	1"1/2	NR	5	01	10,92
1518006	8280 016000000	2"	NR	5	01	19,40
1518107	8280 020000000	2"1/2	NR	1	01	24,72

RACCORDERIA IN OTTONE

RACCORDERIA IN OTTONE GIALLO FILETTATURA CONICA

NIPPLO RIDOTTO M/M



codice	sigla	Ø	UM	min. ord. conf.	cat.	prezzo (€)
1520000	8245 002001000	1/4"x1/8"	NR	10	01	1,16
1520010	8245 003002000	3/8"x1/4"	NR	10	01	1,62
1520011	8245 004002000	1/2"x1/4"	NR	10	01	2,48
1520001	8245 004003000	1/2"x3/8"	NR	10	01	1,91
1520012	8245 006003000	3/4"x3/8"	NR	10	01	3,04
1520002	8245 006004000	3/4"x1/2"	NR	10	01	3,14
1520003	8245 008004000	1"x1/2"	NR	10	01	4,82
1520004	8245 008006000	1"x3/4"	NR	10	01	5,31
1520013	8245 010006000	1"1/4x3/4"	NR	5	01	8,25
1520005	8245 010008000	1"1/4x1"	NR	5	01	7,95
1520014	8245 012006000	1"1/2x3/4"	NR	5	01	10,03
1520006	8245 012008000	1"1/2x1"	NR	5	01	10,30
1520007	8245 012010000	1"1/2x1"1/4	NR	5	01	10,86
1520018	8245 016010000	2"x1"1/4	NR	1	01	20,53
1520009	8245 016012000	2"x1"1/2	NR	1	01	20,20
1520116	8245 020016000	2"1/2x2"	NR	1	01	39,73

TAPPO F



codice	sigla	Ø	UM	min. ord. conf.	cat.	prezzo (€)
1522000	8300 002000000	1/4"	NR	10	01	0,96
1522007	8300 003000000	3/8"	NR	10	01	0,99
1522001	8300 004000000	1/2"	NR	10	01	1,35
1522002	8300 006000000	3/4"	NR	10	01	1,95
1522003	8300 008000000	1"	NR	10	01	3,10
1522004	8300 010000000	1"1/4	NR	10	01	5,61
1522005	8300 012000000	1"1/2	NR	2	01	7,06
1522006	8300 016000000	2"	NR	2	01	14,39

NIPPLO A TUTTO FILETTO M/M, C/ FILETTO CILINDRICO



codice	sigla	Ø	UM	min. ord. conf.	cat.	prezzo (€)
1523007	8531 003000000	3/8"	NR	10	01	1,42
1523001	8531 004000000	1/2"	NR	10	01	2,24
1523002	8531 006000000	3/4"	NR	10	01	3,73
1523003	8531 008000000	1"	NR	5	01	5,28
1523104	8531 010000000	1"1/4	NR	1	01	6,34
1523105	8531 012000000	1"1/2	NR	1	01	11,09
1523106	8531 016000000	2"	NR	1	01	18,05

TAPPO M, CON FILETTO CILINDRICO



codice	sigla	Ø	UM	min. ord. conf.	cat.	prezzo (€)
1521001	8292 002000000	1/4"	NR	10	01	1,16
1521002	8292 003000000	3/8"	NR	10	01	1,42
1521003	8292 004000000	1/2"	NR	10	01	2,05
1521004	8292 006000000	3/4"	NR	10	01	3,04
1521005	8292 008000000	1"	NR	10	01	4,49

TAPPO M, CON QUADRO E FILETTO CILINDRICO



codice	sigla	Ø	UM	min. ord. conf.	cat.	prezzo (€)
1544001	8595 002000000	1/4"	NR	10	01	1,72
1544002	8595 003000000	3/8"	NR	10	01	1,88
1544003	8595 004000000	1/2"	NR	10	01	2,31
1544004	8595 006000000	3/4"	NR	10	01	3,63
1544005	8595 008000000	1"	NR	10	01	6,11
1544006	8595 010000000	1"1/4	NR	5	01	9,14
1544007	8595 012000000	1"1/2	NR	5	01	11,06
1544008	8595 016000000	2"	NR	2	01	19,21

CONTRODADO



codice	sigla	Ø	UM	min. ord. conf.	cat.	prezzo (€)
1537000	8310 002000000	1/4"	NR	10	01	0,99
1537004	8310 003000000	3/8"	NR	10	01	1,39
1537001	8310 004000000	1/2"	NR	10	01	1,72
1537002	8310 006000000	3/4"	NR	10	01	2,44
1537003	8310 008000000	1"	NR	10	01	4,29
1537005	8310 010000000	1"1/4	NR	10	01	6,53
1537006	8310 012000000	1"1/2	NR	5	01	10,13
1537007	8310 016000000	2"	NR	5	01	16,27

GOMITO A 90° F/F, C/FLANGIA A 2 FORI DI FISSAGGIO



codice	sigla	Ø	UM	min. ord. conf.	cat.	prezzo (€)
1550001	8471 004000000	1/2"	NR	10	01	8,35
1550002	8471 006000000	3/4"	NR	10	01	10,82

RACCORDERIA IN OTTONE

RACCORDERIA IN OTTONE GIALLO FILETTATURA CONICA

GHIERA DI RIDUZIONE M/F



codice	sigla	Ø	UM	min. ord. conf.	cat.	prezzo (€)
1528001	8198 004003000	1/2"x3/8"	NR	10	01	0,92
1528002	8198 006004000	3/4"x1/2"	NR	10	01	1,29
1528003	8198 008006000	1"x3/4"	NR	10	01	1,95
1528004	8198 010008000	1"1/4x1"	NR	10	01	3,33
1528105	8198 012010000	1"1/2x1"1/4	NR	5	01	3,23

BARILOTTO M/M



codice	sigla	Ø	lung. (mm)	UM	min. ord. conf.	cat.	prezzo (€)
1535000	8530 004050000	1/2"	50	NR	10	01	4,49
1535001	8530 004060000	1/2"	60	NR	10	01	5,64
1535013	8530 004080000	1/2"	80	NR	10	01	6,57
1535002	8530 004100000	1/2"	100	NR	10	01	8,68
1535014	8530 004120000	1/2"	120	NR	10	01	11,39
1535015	8530 004150000	1/2"	150	NR	5	01	13,13
1535016	8530 004180000	1/2"	180	NR	5	01	15,64
1535010	8530 004200000	1/2"	200	NR	5	01	18,58
1535017	8530 006050000	3/4"	50	NR	10	01	6,70
1535003	8530 006060000	3/4"	60	NR	10	01	7,43
1535018	8530 006080000	3/4"	80	NR	10	01	10,07
1535004	8530 006100000	3/4"	100	NR	10	01	11,98
1535019	8530 006120000	3/4"	120	NR	10	01	17,09
1535020	8530 006150000	3/4"	150	NR	5	01	18,45
1535021	8530 006180000	3/4"	180	NR	5	01	22,31
1535011	8530 006200000	3/4"	200	NR	5	01	23,96
1535022	8530 008050000	1"	50	NR	5	01	9,41
1535005	8530 008060000	1"	60	NR	5	01	10,46
1535023	8530 008080000	1"	80	NR	5	01	13,93
1535006	8530 008100000	1"	100	NR	5	01	15,81
1535038	8530 008120000	1"	120	NR	5	01	23,30
1535025	8530 008150000	1"	150	NR	5	01	27,92
1535026	8530 008180000	1"	180	NR	5	01	35,54
1535012	8530 008200000	1"	200	NR	5	01	35,01
1535008	8530 010100000	1"1/4	100	NR	5	01	25,48
1535029	8530 010150000	1"1/4	150	NR	1	01	37,13
1535031	8530 010200000	1"1/4	200	NR	1	01	52,87
1535009	8530 012100000	1"1/2	100	NR	1	01	32,34
1535035	8530 012150000	1"1/2	150	NR	1	01	44,75
1535037	8530 012200000	1"1/2	200	NR	1	01	63,86

PROLUNGA M/F, CON FILETTO CILINDRICO



codice	sigla	Ø	lung. (mm)	UM	min. ord. conf.	cat.	prezzo (€)
1532001	8540 003010000	3/8"	10	NR	10	01	1,55
1532025	8540 003015000	3/8"	15	NR	10	01	1,85
1532002	8540 003020000	3/8"	20	NR	10	01	2,28
1532026	8540 003025000	3/8"	25	NR	10	01	2,90
1532003	8540 003030000	3/8"	30	NR	10	01	3,14
1532004	8540 003040000	3/8"	40	NR	10	01	4,09
1532005	8540 003050000	3/8"	50	NR	10	01	5,05
1533001	8540 004010000	1/2"	10	NR	10	01	2,08
1533002	8540 004015000	1/2"	15	NR	10	01	2,71
1533003	8540 004020000	1/2"	20	NR	10	01	3,27
1532009	8540 004025000	1/2"	25	NR	10	01	4,03
1533004	8540 004030000	1/2"	30	NR	10	01	4,42
1532011	8540 004040000	1/2"	40	NR	10	01	5,54
1532012	8540 004050000	1/2"	50	NR	10	01	6,96
1532013	8540 004060000	1/2"	60	NR	10	01	8,02
1532027	8540 004070000	1/2"	70	NR	10	01	9,83
1532028	8540 004080000	1/2"	80	NR	10	01	10,46
1532029	8540 004100000	1/2"	100	NR	10	01	12,71
1532014	8540 006010000	3/4"	10	NR	10	01	2,84
1532015	8540 006015000	3/4"	15	NR	10	01	3,47
1532016	8540 006020000	3/4"	20	NR	10	01	3,96
1532030	8540 006025000	3/4"	25	NR	10	01	5,12
1532017	8540 006030000	3/4"	30	NR	10	01	5,41
1532018	8540 006040000	3/4"	40	NR	10	01	7,52
1532019	8540 006050000	3/4"	50	NR	10	01	8,45
1532021	8540 008010000	1"	10	NR	5	01	4,39
1532022	8540 008015000	1"	15	NR	5	01	4,72
1532023	8540 008020000	1"	20	NR	5	01	6,30
1532031	8540 008025000	1"	25	NR	5	01	7,69
1532024	8540 008030000	1"	30	NR	5	01	7,85
1532032	8540 008040000	1"	40	NR	5	01	11,45
1532033	8540 008050000	1"	50	NR	5	01	13,27
1532034	8540 008060000	1"	60	NR	5	01	15,68

RIDUZIONE F/M, CON FILETTO CILINDRICO



codice	sigla	Ø	UM	min. ord. conf.	cat.	prezzo (€)
1534000	8243 002001000	1/4"x1/8"	NR	10	01	1,58
1534005	8243 003002000	3/8"x1/4"	NR	10	01	1,78
1534006	8243 004002000	1/2"x1/4"	NR	10	01	2,05
1534001	8243 004003000	1/2"x3/8"	NR	10	01	3,00
1534007	8243 006003000	3/4"x3/8"	NR	10	01	3,07
1534002	8243 006004000	3/4"x1/2"	NR	10	01	4,06
1534003	8243 008004000	1"x1/2"	NR	10	01	5,31
1534004	8243 008006000	1"x3/4"	NR	10	01	6,04
1534008	8243 010004000	1"1/4x1/2"	NR	5	01	5,71
1534009	8243 010006000	1"1/4x3/4"	NR	5	01	5,41
1534010	8243 010008000	1"1/4x1"	NR	5	01	8,22

RACCORDERIA IN OTTONE

RACCORDERIA IN OTTONE GIALLO FILETTATURA CONICA

SCORREVOLE M/M, CON FILETTO CILINDRICO



codice	sigla	Ø	UM	min. ord. conf.	cat.	prezzo (€)
1545001	8532 004150000	1/2"x150 mm.	NR	1	01	11,85
1545002	8532 004200000	1/2"x200 mm.	NR	1	01	19,01
1545003	8532 006150000	3/4"x150 mm.	NR	1	01	19,57
1545005	8532 008150000	1"x150 mm.	NR	1	01	25,58

RACCORDO PER CISTERNA



codice	sigla	Ø	UM	min. ord. conf.	cat.	prezzo (€)
1546001	8535 004000000	1/2"	NR	10	01	10,23
1546002	8535 006000000	3/4"	NR	5	01	14,45
1546003	8535 008000000	1"	NR	5	01	23,56
1546004	8535 010000000	1"1/4	NR	2	01	30,10
1546005	8535 012000000	1"1/2	NR	1	01	41,48
1546006	8535 016000000	2"	NR	1	01	60,32

BOCCHETTONE F/F, A TENUTA METALLICA



codice	sigla	Ø	UM	min. ord. conf.	cat.	prezzo (€)
1508001	8125 004000000	1/2"	NR	5	01	12,47
1508002	8125 006000000	3/4"	NR	10	01	19,40
1508003	8125 008000000	1"	NR	5	01	24,82

BOCCHETTONE M/F, A TENUTA METALLICA



codice	sigla	Ø	UM	min. ord. conf.	cat.	prezzo (€)
1509001	8126 004000000	1/2"	NR	10	01	8,81
1509002	8126 006000000	3/4"	NR	10	01	13,43
1509003	8126 008000000	1"	NR	5	01	20,26

BOCCHETTONE M/F, A TENUTA O-RING (solo per acqua)



codice	sigla	Ø	UM	min. ord. conf.	cat.	prezzo (€)
1510000	8126G003000000	3/8"	NR	10	01	5,41
1510001	8126G004000000	1/2"	NR	10	05	6,59
1510002	8126G006000000	3/4"	NR	10	05	10,21
1510003	8126G008000000	1"	NR	5	05	14,98
1510004	8126G010000000	1"1/4	NR	5	01	25,18
1510005	8126G012000000	1"1/2	NR	1	01	46,86
1510006	8126G016000000	2"	NR	1	01	83,89

BOCCHETTONE 90° M/F, A TENUTA O-RING (solo per acqua)



codice	sigla	Ø	UM	min. ord. conf.	cat.	prezzo (€)
1511007	8098G003000000	3/8"	NR	10	01	6,01
1511001	8098G004000000	1/2"	NR	10	05	7,26
1511002	8098G006000000	3/4"	NR	10	05	12,83
1511003	8098G008000000	1"	NR	5	05	19,78
1511004	8098G010000000	1"1/4	NR	5	01	21,75
1511005	8098G012000000	1"1/2	NR	1	01	51,88
1511006	8098G016000000	2"	NR	1	01	131,77

RACCORDERIA IN OTTONE GIALLO FILETTATURA CILINDRICA

Conforme alla normativa vigente per il tipo di lega:

- UNI EN 12165 per i particolari stampati.
- UNI EN 12164 per i particolari da barra.
- Contenuto di piombo inferiore al limite ammesso dalla Direttiva Europea 98/83/CE

Filettatura:

Raccordi in ottone CW617N-DW con filettatura secondo ISO 228-1. Idonei per applicazioni con acqua calda e fredda, impianti di riscaldamento, solare termico con miscele acqua/glicole max. fino al 50%, raffrescamento, aria compressa (priva di olii).

Tutti gli elementi elastomerici sono in EPDM nero conformi alla norma UNI EN 681-1: idonei per il trasporto di acque destinate al consumo umano (potabili)

GOMITO A 90° F/F



codice	sigla	Ø	UM	min. ord. conf.	cat.	prezzo (€)
1502201	8090 M04000000	1/2"	NR	10	05	2,85
1502202	8090 M06000000	3/4"	NR	10	05	4,93
1502203	8090 M08000000	1"	NR	5	05	8,06

GOMITO A 90° M/F



codice	sigla	Ø	UM	min. ord. conf.	cat.	prezzo (€)
1505201	8092 M04000000	1/2"	NR	10	05	3,14
1505202	8092 M06000000	3/4"	NR	10	05	4,83
1505203	8092 M08000000	1"	NR	10	05	8,58

MANICOTTO F/F



codice	sigla	Ø	UM	min. ord. conf.	cat.	prezzo (€)
1516201	8270 M04000000	1/2"	NR	10	05	2,14
1516202	8270 M06000000	3/4"	NR	10	05	3,30
1516203	8270 M08000000	1"	NR	10	05	5,18

MANICOTTO RIDOTTO F/F



codice	sigla	Ø	UM	min. ord. conf.	cat.	prezzo (€)
1517202	8240 M06004000	3/4"x1/2"	NR	10	05	2,46
1517203	8240 M08004000	1"x1/2"	NR	5	05	3,52
1517204	8240 M08006000	1"x3/4"	NR	5	05	3,90

NIPPLLO M/M



codice	sigla	Ø	UM	min. ord. conf.	cat.	prezzo (€)
1519200	8280 M03000000	3/8"	NR	10	05	1,15
1519201	8280 M04000000	1/2"	NR	10	05	1,57
1519202	8280 M06000000	3/4"	NR	10	05	2,37
1519203	8280 M08000000	1"	NR	10	05	3,74

NIPPLLO RIDOTTO M/M



codice	sigla	Ø	UM	min. ord. conf.	cat.	prezzo (€)
1520201	8245 M04003000	1/2"x3/8"	NR	10	05	1,44
1520202	8245 M06004000	3/4"x1/2"	NR	10	05	2,21
1520203	8245 M08004000	1"x1/2"	NR	10	05	3,26
1520204	8245 M08006000	1"x3/4"	NR	10	05	3,26

TEE F/F/F



codice	sigla	Ø	UM	min. ord. conf.	cat.	prezzo (€)
1513201	8130 M04004004	1/2"	NR	10	05	3,42
1513202	8130 M06006006	3/4"	NR	10	05	6,21
1513203	8130 M08008008	1"	NR	5	05	9,95

BOCCHETTONE M/F, A TENUTA O-RING



codice	sigla	Ø	UM	min. ord. conf.	cat.	prezzo (€)
1510201	8126GM04000000	1/2"	NR	10	05	5,38
1510202	8126GM06000000	3/4"	NR	10	05	8,06
1510203	8126GM08000000	1"	NR	5	05	14,18

RACCORDERIA IN OTTONE

RACCORDERIA IN OTTONE GIALLO FILETTATURA CILINDRICA

RIDUZIONE ESAGONALE M/F



codice	sigla	Ø	UM	min. ord. conf.	cat.	prezzo (€)
1525207	8241 M03002000	3/8"x1/4"	NR	10	05	0,77
1525201	8241 M04002000	1/2"x1/4"	NR	10	05	1,31
1525202	8241 M04003000	1/2"x3/8"	NR	10	05	0,90
1525216	8241 M06003000	3/4"x3/8"	NR	10	05	1,95
1525203	8241 M06004000	3/4"x1/2"	NR	10	05	1,47
1525204	8241 M08004000	1"x1/2"	NR	10	05	3,17
1525205	8241 M08006000	1"x3/4"	NR	10	05	2,37
1525208	8241 M10004000	1"1/4x1/2"	NR	5	05	5,79
1525209	8241 M10006000	1"1/4x3/4"	NR	5	05	4,96
1525210	8241 M10008000	1"1/4x1"	NR	5	05	4,00
1525211	8241 M12004000	1"1/2x1/2"	NR	5	05	9,28
1525213	8241 M12008000	1"1/2x1"	NR	5	05	6,24
1525214	8241 M12010000	1"1/2x1"1/4	NR	5	05	4,35
1525215	8241 M16004000	2"x1/2"	NR	1	05	13,15

PROLUNGA M/F



codice	sigla	Ø	lung. (mm)	UM	min. ord. conf.	cat.	prezzo (€)
1533201	8540 M04010000	1/2"	10	NR	10	05	1,63
1533202	8540 M04015000	1/2"	15	NR	10	05	2,08
1533203	8540 M04020000	1/2"	20	NR	10	05	2,50
1533204	8540 M04030000	1/2"	30	NR	10	05	3,39
1533206	8540 M04040000	1/2"	40	NR	10	05	4,13
1532214	8540 M06010000	3/4"	10	NR	10	05	2,50
1532215	8540 M06015000	3/4"	15	NR	10	05	2,98
1532216	8540 M06020000	3/4"	20	NR	10	05	3,46
1532217	8540 M06030000	3/4"	30	NR	10	05	4,58
1532211	8540 M06040000	3/4"	40	NR	10	05	5,60
1532212	8540 M06050000	3/4"	50	NR	5	05	6,75
1532221	8540 M08030000	1"	30	NR	10	05	6,85

PROLUNGA RIDOTTA F/M



codice	sigla	Ø	UM	min. ord. conf.	cat.	prezzo (€)
1534201	8243 M04003000	1/2"x3/8"	NR	10	05	1,66
1534202	8243 M06004000	3/4"x1/2"	NR	10	05	2,69
1534203	8243 M08004000	1"x1/2"	NR	10	05	4,16
1534204	8243 M08006000	1"x3/4"	NR	10	05	4,16
1534211	8243 M10008000	1"1/4x1"	NR	5	05	7,14
1534212	8243 M12010000	1"1/2x1"1/4	NR	5	05	8,58

TAPPO M



codice	sigla	Ø	UM	min. ord. conf.	cat.	prezzo (€)
1521203	8292 M04000000	1/2"	NR	10	05	0,93
1521204	8292 M06000000	3/4"	NR	10	05	1,57
1521205	8292 M08000000	1"	NR	5	05	2,75
1521206	8292 M10000000	1"1/4	NR	5	05	4,74

PORTAGOMMA M, TIPO ROMA



codice	sigla	Ø	UM	min. ord. conf.	cat.	prezzo (€)
1526301	81004M03010000	3/8"x10 mm.	NR	10	05	2,46
1526302	81004M04010000	1/2"x10 mm.	NR	10	05	2,53
1526304	81004M04014000	1/2"x14 mm.	NR	10	05	3,74
1526305	81004M04016000	1/2"x16 mm.	NR	10	05	3,81
1526306	81004M04018000	1/2"x18 mm.	NR	10	05	3,94
1526307	81004M04020000	1/2"x20 mm.	NR	10	05	4,22
1526308	81004M06020000	3/4"x20 mm.	NR	10	05	4,51
1526309	81004M06025000	3/4"x25 mm.	NR	10	05	5,66
1526310	81004M08025000	1"x25 mm.	NR	5	05	6,88
1526311	81004M08030000	1"x30 mm.	NR	5	05	7,94
1526312	81004M12040000	1"1/2x40 mm.	NR	5	05	15,81

TAPPO F



codice	sigla	Ø	UM	min. ord. conf.	cat.	prezzo (€)
1522201	8300 M04000000	1/2"	NR	10	05	1,22
1522202	8300 M06000000	3/4"	NR	10	05	1,82
1522203	8300 M08000000	1"	NR	5	05	2,88

PORTAGOMMA F, TIPO ROMA



codice	sigla	Ø	UM	min. ord. conf.	cat.	prezzo (€)
1527300	81005M04010000	1/2"x10 mm.	NR	10	05	2,53
1527302	81005M04014000	1/2"x14 mm.	NR	10	05	3,04
1527306	81005M06020000	3/4"x20 mm.	NR	10	05	4,93
1527307	81005M08025000	1"x25 mm.	NR	5	05	7,78

Conforme alla norma UNI EN 1254 parti 2 e 4.
Certificata DVGW.

A tenuta metallica

UTILIZZO CON UN UNICO RACCORDO PER:

- Acqua
- Aria compressa
- Gas
- Solare (concentrazione Glicole max 50%)

I raccordi possono essere utilizzati con tubazioni:

- Rame (secondo EN 1057)
- Acciaio inox (secondo EN 10312)
- Acciaio al carbonio (secondo EN 10305-3)
- Polietilene reticolato e media densità

MANICOTTO F/F



codice	sigla	Ø	UM	min. ord. conf.	cat.	prezzo (€)
6500001	AA-5020301--	6	NR	10	07	6,97
6500003	BB-5020301--	8	NR	10	07	7,07
6500004	CC-5020301--	10	NR	10	07	5,92
6500006	DD-1020301--	12	NR	10	07	6,30
6500009	TT-1020301--	14	NR	10	07	7,46
6500010	EE-1020301--	15	NR	10	07	6,90
6500014	UU-1020301--	16	NR	10	07	7,56
6500016	FF-1020301--	18	NR	10	07	9,35
6500020	GG-1020301--	22	NR	10	07	11,38

MANICOTTO F/FILETTO M, CON FILETTO CONICO



codice	sigla	Ø	UM	min. ord. conf.	cat.	prezzo (€)
6503004	D021020302TA	12x3/8"	NR	10	07	7,39
6503003	D031020302TA	12x1/2"	NR	10	07	8,93
6503016	T031020302TA	14x1/2"	NR	10	07	5,71
6503005	E031020302TA	15x1/2"	NR	10	07	6,37
6503017	U031020302TA	16x1/2"	NR	10	07	6,37
6503008	U041020302TA	16x3/4"	NR	10	07	10,89
6503009	F031020302TA	18x1/2"	NR	10	07	10,85
6503010	F041020302TA	18x3/4"	NR	10	07	12,81
6503012	G031020302TA	22x1/2"	NR	10	07	13,44
6503013	G041020302TA	22x3/4"	NR	10	07	13,02
6503011	G051020302TA	22x1"	NR	10	07	22,61
6503014	H051020302TA	28x1"	NR	10	07	21,84

MANICOTTO F/FILETTO M, CON FILETTO CILINDRICO



codice	sigla	Ø	UM	min. ord. conf.	cat.	prezzo (€)
6502002	A011020302--	6x1/4"	NR	10	07	5,74
6502005	B015020302--	8x1/4"	NR	10	07	5,74
6502003	B025020302--	8x3/8"	NR	10	07	6,83
6502008	C025020302--	10x3/8"	NR	10	07	5,43
6502006	C035020302--	10x1/2"	NR	10	07	4,87
6502011	D021020302--	12x3/8"	NR	10	07	4,24
6502009	D031020302--	12x1/2"	NR	10	07	4,45
6502012	E031020302--	15x1/2"	NR	10	07	8,05
6502016	F031020302--	18x1/2"	NR	10	07	7,18
6502017	F041020302--	18x3/4"	NR	10	07	7,46
6502022	G041020302--	22x3/4"	NR	10	07	9,07
6502020	G051020302--	22x1"	NR	10	07	11,66
6502023	H051020302--	28x1"	NR	10	07	15,16
6502027	J061020302--	35x1"1/4	NR	1	07	29,19

MANICOTTO F/FILETTO F



codice	sigla	Ø	UM	min. ord. conf.	cat.	prezzo (€)
6504003	C025020303--	10x3/8"	NR	10	07	4,66
6504001	C035020303--	10x1/2"	NR	10	07	5,11
6504005	D021020303--	12x3/8"	NR	10	07	4,76
6504004	D031020303--	12x1/2"	NR	10	07	5,08
6504006	T031020303--	14x1/2"	NR	10	07	6,02
6504008	E031020303--	15x1/2"	NR	10	07	8,05
6504011	U031020303--	16x1/2"	NR	10	07	6,55
6504012	U041020303--	16x3/4"	NR	10	07	9,66
6504013	F031020303--	18x1/2"	NR	10	07	8,96
6504014	F041020303--	18x3/4"	NR	10	07	8,47
6504019	G041020303--	22x3/4"	NR	10	07	11,06
6504017	G051020303--	22x1"	NR	10	07	13,65
6504022	H041020303--	28x3/4"	NR	10	07	18,62
6504020	H051020303--	28x1"	NR	10	07	17,40

GOMITO A 90° F/F



codice	sigla	Ø	UM	min. ord. conf.	cat.	prezzo (€)
6506003	CC-5020401--	10	NR	10	07	9,80
6506004	DD-1020401--	12	NR	10	07	7,81
6506005	TT-1020401--	14	NR	10	07	8,75
6506009	UU-1020401--	16	NR	10	07	9,59
6506010	FF-1020401--	18	NR	10	07	14,70
6506013	GG-1020401--	22	NR	10	07	15,16

RACCORDERIA IN OTTONE

CONEX COMPRESSION

GOMITO A 90° F FILETTO M, CON FILETTO CILINDRICO



codice	sigla	Ø	UM	min. ord. conf.	cat.	prezzo (€)
6507001	C035020402--	10x1/2"	NR	10	07	10,78
6507003	D035020402--	12x3/8"	NR	10	07	6,79
6507009	F045020402--	18x3/4"	NR	10	07	12,08
6507013	G041020402--	22x3/4"	NR	10	07	14,81

GOMITO A 90° F/FILETTO M, CON FILETTO CONICO



codice	sigla	Ø	UM	min. ord. conf.	cat.	prezzo (€)
6508002	D031020402TA	12x1/2"	NR	10	07	11,06
6508004	T031020402TA	14x1/2"	NR	10	07	9,00
6508008	U031020402TA	16x1/2"	NR	10	07	9,42
6508011	F041020402TA	18x3/4"	NR	10	07	16,21
6508013	G041020402TA	22x3/4"	NR	10	07	13,93

GOMITO A 90° F/FILETTO F



codice	sigla	Ø	UM	min. ord. conf.	cat.	prezzo (€)
6509003	C025020403--	10x3/8"	NR	10	07	8,54
6509002	C035020403--	10x1/2"	NR	10	07	9,00
6509004	D031020403--	12x1/2"	NR	10	07	7,67
6509006	T031020403--	14x1/2"	NR	10	07	8,23
6509010	U031020403--	16x1/2"	NR	10	07	9,07
6509011	U041020403--	16x3/4"	NR	10	07	14,53
6509012	F031020403--	18x1/2"	NR	10	07	11,66
6509013	F045020403--	18x3/4"	NR	10	07	12,67
6509017	G041020403--	22x3/4"	NR	10	07	14,81

GOMITO A 90° F/FILETTO F, CON FLANGIA A 2 FORI DI FISSAGGIO



codice	sigla	Ø	UM	min. ord. conf.	cat.	prezzo (€)
6510002	D031020403W-	12x1/2"	NR	10	07	16,52
6510001	T031020403W-	14x1/2"	NR	10	07	16,80
6510003	E031020403W-	15x1/2"	NR	10	07	14,81

GOMITO A 90° F/FILETTO F, CON FLANGIA A 3 FORI DI FISSAGGIO



codice	sigla	Ø	UM	min. ord. conf.	cat.	prezzo (€)
6511001	D035020403WL	12x1/2"	NR	10	07	16,35



Corpo raccordo conforme alle norme UNI EN 1254-2, UNI EN 1254-4

APPLICAZIONI PER ACQUA:

- O-ring nero EPDM conforme alla norma UNI EN 681-1.
- Elemento elastomerico di colore nero idoneo per il trasporto e la distribuzione di acque destinate al consumo umano.
- Installazione per impianti di acqua sanitaria fredda e calda, di riscaldamento e di miscele acqua/glicole fino al 50%.
- Pressioni massime di esercizio:
 - 16 bar per temperature di 95°
 - 10 bar per temperature di 110°

APPLICAZIONI PER GAS:

- O-ring giallo HNBR conforme alla norma DIN EN 549.
- Elemento elastomerico di colore giallo idoneo alla realizzazione di impianti per trasporto e/o distribuzione di combustibili liquidi e gassosi.
- Famiglie di gas combustibili:
 - 1ª (gruppo A-gas manifatturato)
 - 2ª (gruppo H-gas naturale o metano)
 - 3ª (GPL)

In ogni confezione ci sono in dotazione gli O-ring giallo e nero.

MANICOTTO DIRITTO F/F



codice	sigla	Ø	UM	min. ord. conf.	cat.	prezzo (€)
6601001	IG301 01000000	10	NR	1	01	5,25
6601002	IG301 01200000	12	NR	1	01	6,44
6601003	IG301 01400000	14	NR	1	01	7,19
6601004	IG301 01600000	16	NR	1	01	8,65
6601005	IG301 01800000	18	NR	1	01	10,00
6601006	IG301 02200000	22	NR	1	01	16,17
6601007	IG301 02800000	28	NR	1	01	20,86

MANICOTTO F/FILETTO M



codice	sigla	Ø	UM	min. ord. conf.	cat.	prezzo (€)
6602001	IG302 01003000	10x3/8"	NR	1	01	3,40
6602002	IG302 01004000	10x1/2"	NR	1	01	4,26
6602003	IG302 01203000	12x3/8"	NR	1	01	3,76
6602004	IG302 01204000	12x1/2"	NR	1	01	3,93
6602005	IG302 01403000	14x3/8"	NR	1	01	4,95
6602006	IG302 01404000	14x1/2"	NR	1	01	4,49
6602007	IG302 01406000	14x3/4"	NR	1	01	6,34
6602009	IG302 01604000	16x1/2"	NR	1	01	5,21
6602010	IG302 01606000	16x3/4"	NR	1	01	7,39
6602011	IG302 01804000	18x1/2"	NR	1	01	6,47
6602012	IG302 01806000	18x3/4"	NR	1	01	7,16
6602015	IG302 02206000	22x3/4"	NR	1	01	10,49
6602016	IG302 02208000	22x1"	NR	1	01	13,23
6602017	IG302 02806000	28x3/4"	NR	1	01	15,84
6602018	IG302 02808000	28x1"	NR	1	01	15,71

MANICOTTO F/FILETTO F



codice	sigla	Ø	UM	min. ord. conf.	cat.	prezzo (€)
6603001	IG303 01003000	10x3/8"	NR	1	01	4,03
6603002	IG303 01004000	10x1/2"	NR	1	01	4,32
6603003	IG303 01203000	12x3/8"	NR	1	01	4,46
6603004	IG303 01204000	12x1/2"	NR	1	01	4,52
6603005	IG303 01403000	14x3/8"	NR	1	01	5,08
6603006	IG303 01404000	14x1/2"	NR	1	01	4,69
6603007	IG303 01406000	14x3/4"	NR	1	01	7,43
6603009	IG303 01604000	16x1/2"	NR	1	01	6,24
6603010	IG303 01606000	16x3/4"	NR	1	01	7,89
6603011	IG303 01804000	18x1/2"	NR	1	01	6,93
6603012	IG303 01806000	18x3/4"	NR	1	01	7,89
6603015	IG303 02206000	22x3/4"	NR	1	01	10,16
6603016	IG303 02208000	22x1"	NR	1	01	14,09
6603017	IG303 02806000	28x3/4"	NR	1	01	17,46
6603018	IG303 02808000	28x1"	NR	1	01	16,93

GOMITO A 90° F/F



codice	sigla	Ø	UM	min. ord. conf.	cat.	prezzo (€)
6604001	IG401 01000000	10	NR	1	01	7,66
6604002	IG401 01200000	12	NR	1	01	8,42
6604003	IG401 01400000	14	NR	1	01	9,47
6604004	IG401 01600000	16	NR	1	01	11,48
6604005	IG401 01800000	18	NR	1	01	13,83
6604006	IG401 02200000	22	NR	1	01	20,82

RACCORDERIA IN OTTONE

CONEX O-RING ACQUA E GAS

GOMITO A 90° F/FILETTO M



codice	sigla	Ø	UM	min. ord. conf.	cat.	prezzo (€)
6605002	IG402 01004000	10x1/2"	NR	1	01	7,92
6605003	IG402 01203000	12x3/8"	NR	1	01	6,50
6605004	IG402 01204000	12x1/2"	NR	1	01	6,47
6605006	IG402 01404000	14x1/2"	NR	1	01	6,80
6605009	IG402 01604000	16x1/2"	NR	1	01	8,25
6605010	IG402 01606000	16x3/4"	NR	1	01	10,82
6605011	IG402 01804000	18x1/2"	NR	1	01	11,15
6605012	IG402 01806000	18x3/4"	NR	1	01	10,56
6605014	IG402 02206000	22x3/4"	NR	1	01	17,52

GOMITO A 90° F/FILETTO F



codice	sigla	Ø	UM	min. ord. conf.	cat.	prezzo (€)
6606001	IG403 01003000	10x3/8"	NR	1	01	6,63
6606002	IG403 01004000	10x1/2"	NR	1	01	7,82
6606003	IG403 01203000	12x3/8"	NR	1	01	8,02
6606004	IG403 01204000	12x1/2"	NR	1	01	7,23
6606006	IG403 01404000	14x1/2"	NR	1	01	7,46
6606009	IG403 01604000	16x1/2"	NR	1	01	8,84
6606010	IG403 01606000	16x3/4"	NR	1	01	12,14
6606011	IG403 01804000	18x1/2"	NR	1	01	12,41
6606012	IG403 01806000	18x3/4"	NR	1	01	10,76
6606014	IG403 02206000	22x3/4"	NR	1	01	18,08
6606015	IG403 02208000	22x1"	NR	1	01	22,80
6606017	IG403 02808000	28x1"	NR	1	01	29,87

GOMITO A 90° F/FILETTO F, CON FLANGIA A 3 FORI DI FISSAGGIO



codice	sigla	Ø	UM	min. ord. conf.	cat.	prezzo (€)
6607001	IG403L01004000	10x1/2"	NR	1	01	12,71
6607002	IG403L01204000	12x1/2"	NR	1	01	10,00
6607003	IG403L01404000	14x1/2"	NR	1	01	11,68
6607004	IG403L01604000	16x1/2"	NR	1	01	12,67

TEE F/F/F



codice	sigla	Ø	UM	min. ord. conf.	cat.	prezzo (€)
6608001	IG601 01000000	10	NR	1	01	12,84
6608002	IG601 01200000	12	NR	1	01	11,39
6608003	IG601 01400000	14	NR	1	01	12,77
6608004	IG601 01600000	16	NR	1	01	15,97
6608005	IG601 01800000	18	NR	1	01	20,39
6608006	IG601 02200000	22	NR	1	01	30,72

TEE F / FILETTO F/F



codice	sigla	Ø	UM	min. ord. conf.	cat.	prezzo (€)
6609002	IG617 01004000	10x1/2"	NR	1	01	11,19
6609004	IG617 01204000	12x1/2"	NR	1	01	11,95
6609005	IG617 01404000	14x1/2"	NR	1	01	13,00
6609006	IG617 01604000	16x1/2"	NR	1	01	16,14
6609008	IG617 01804000	18x1/2"	NR	1	01	17,89
6609011	IG617 02206000	22x3/4"	NR	1	01	27,46

SARACINESCA PN 16

Corpo in ottone, volantino in acciaio.
Attacchi femmina.
Temperatura d'esercizio: 0°C / +100°C

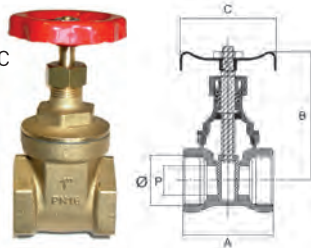

codice	Ø	A	B	C	P	UM	min. ord.	conf.	cat.	prezzo (€)
● 1529001	1/2"	38	68	45	15	NR	15	15	21	15,12
● 1529002	3/4"	44	78	50	19	NR	15	15	21	21,17
● 1529003	1"	48	91	55	24	NR	10	10	21	33,14
● 1529004	1"1/4	51	108	60	32	NR	1	4	21	47,58
● 1529005	1"1/2	58	125	70	37	NR	1	2	21	59,77
● 1529006	2"	63	143	80	47	NR	1	2	21	89,68
● 1529007	2"1/2	64	175	100	60	NR	1	1	21	129,92
● 1529008	3"	74	200	100	72	NR	1	1	21	164,58

VALVOLE DI RITEGNO PASSAGGIO TOTALE, F/F

Molla in acciaio inox AISI 302, guarnizione in NBR, otturatore in FORTRON (PPS) un tecnopolimero semi-cristallino caricato con fibra di vetro (elevata resistenza meccanica, chimica, e alle alte temperature). Temperatura d'esercizio: -20°C / +100°C

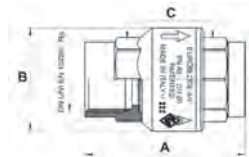

codice	Ø	PN	A	B	C	UM	min. ord.	conf.	cat.	prezzo (€)
● 1911001	3/8"	40	47	27	21	NR	1	40	02	9,42
● 1911002	1/2"	40	59	34,5	26	NR	30	120	02	10,91
● 1911003	3/4"	40	65	42	32	NR	20	80	02	14,69
● 1911004	1"	25	75	49	39	NR	10	70	02	20,23
● 1911005	1"1/4	25	83,5	61	49	NR	1	36	02	31,82
● 1911006	1"1/2	16	89	73	55	NR	1	24	02	46,65
● 1911007	2"	16	101,5	87,5	68	NR	1	12	02	67,42
● 1911008	2"1/2	12	121	111,5	83	NR	1	2	02	143,04
● 1911009	3"	12	136	133	98	NR	1	2	02	208,35

VALVOLA DI FONDO

Corpo e filtro in ottone, otturatore in ottone con guarnizione SBR
Temperatura d'esercizio: 0°C / +90°C

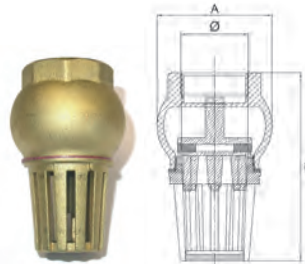

codice	Ø	PN	A	B	UM	min. ord.	conf.	cat.	prezzo (€)
● 1914003	1"	10	51	81	NR	1	15	21	18,09
● 1914004	1"1/4	8	61	95	NR	1	6	21	27,82

VALVOLA DI FONDO TUBOLARE

Corpo e filtro in ottone, otturatore in ottone con guarnizione SBR e rondella in acciaio inox AISI 304
Temperatura d'esercizio: 0°C / +90°C



codice	Ø	PN	A	B	UM	min. ord.	conf.	cat.	prezzo (€)
● 1913002	3/4"	10	30	100	NR	1	20	21	19,34
● 1913003	1"	10	39	114	NR	1	15	21	24,40
● 1913004	1"1/4	8	46	127	NR	1	10	21	37,47

FILTRO VALVOLA DI RITEGNO

Filtro in acciaio inox AISI 304, raccordo maschio in nylon
Temperatura d'esercizio: 0°C / +110°C



codice	Ø	A	B	C	D	UM	min. ord.	conf.	cat.	prezzo (€)
● 1912003	3/4"	33	56	29	42	NR	10	10	09	2,32
● 1912004	1"	41	58	36	43	NR	10	10	09	2,88
● 1912005	1"1/4	50	69	44	53	NR	1	10	09	3,52
● 1912006	1"1/2	55	78	49	62	NR	1	10	09	4,16
● 1912007	2"	67	96	61	79	NR	1	10	09	5,44
● 1912008	2"1/2	86	98	80	76	NR	1	10	09	9,80

FILTRO RACCOGLI IMPURITÀ PN20

Corpo e tappo d'ispezione in ottone, filtro acciaio inox AISI 302. Attacchi femmina
Temperatura d'esercizio: 0°C / +80°C

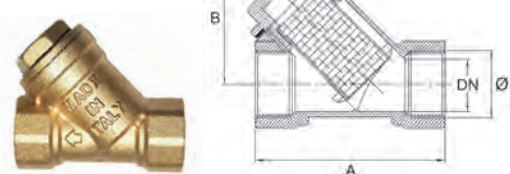

codice	Ø	A	B	DN	filtraggio	UM	min. ord.	conf.	cat.	prezzo (€)
● 1530001	1/2"	58	40	15	500µ	NR	20	20	21	9,16
● 1530002	3/4"	70	50	20	500µ	NR	12	12	21	14,59
● 1530003	1"	75	60	25	500µ	NR	12	12	21	21,43
● 1530004	1"1/4	96	68	32	500µ	NR	1	4	21	35,26
● 1530005	1"1/2	106	75	40	500µ	NR	1	3	21	46,36
● 1530006	2"	126	90	50	500µ	NR	1	2	21	76,91
● 1530009	2"1/2	146	100	65	1000µ	NR	1	1	21	143,91

RACCORDERIA IN OTTONE

VALVOLE

VALVOLA CLAPET SEDE GOMMA

Corpo e tappo in ottone, otturatore in ottone con guarnizione NBR
Temperatura d'esercizio: 0°C / +100°C

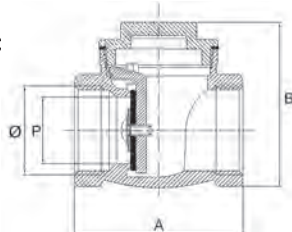

codice	Ø	PN	A	B	P	UM	min. ord.	conf.	cat.	prezzo (€)
● 1531101	1/2"	10	47	46	15	NR	20	20	21	12,16
● 1531102	3/4"	10	53	51	20	NR	15	15	21	16,49
● 1531103	1"	10	63	61	25	NR	10	10	21	24,09
● 1531104	1"1/4	10	74	73	33	NR	1	8	21	31,69
● 1531105	1"1/2	10	87	85	37	NR	1	6	21	46,51
● 1531106	2"	10	97	94	47	NR	1	3	21	66,73
● 1531107	2"1/2	6	118	107	55	NR	1	1	21	111,23

RACCORDO A 5 VIE

Attacchi 1/4"
Altezza 72 mm



codice	Ø	UM	min. ord.	conf.	cat.	prezzo (€)
● 1536001	1"	NR	1	10	21	14,86

RACCORDI PER TUBO FERRO

Raccordo per tubazioni di ferro utilizzate negli impianti di distribuzione acqua, gas e acqua potabile.

Le tubazioni devono essere conformi alla norma UNI 8863.

Nel caso di impianti a gas devono essere utilizzate le apposite guarnizioni di tenuta in gomma silconica identificabili dal colore rosso (non a corredo).

Tenuta meccanica con anello conico inox AISI 303 e guarnizione conica in EPDM.

Temperatura d'esercizio da -20°C a +120°C, pressione d'esercizio 50 bar.

TUBOFIX MASCHIO



codice	Ø	UM	min. ord.	conf.	cat.	prezzo (€)
● 1540000	3/8"	NR	24	24	04	17,92
● 1540001	1/2"	NR	24	24	04	20,18
● 1540002	3/4"	NR	24	24	04	25,39
● 1540003	1"	NR	12	12	04	32,24
● 1540004	1"1/4	NR	1	12	04	49,82
● 1540005	1"1/2	NR	1	6	04	62,50
● 1540006	2"	NR	1	4	04	96,04

TUBOFIX FEMMINA



codice	Ø	UM	min. ord.	conf.	cat.	prezzo (€)
● 1541007	3/8"	NR	24	24	04	17,92
● 1541001	1/2"	NR	24	24	04	20,18
● 1541002	3/4"	NR	24	24	04	25,39
● 1541003	1"	NR	12	12	04	32,24
● 1541004	1"1/4	NR	1	12	04	49,82
● 1541005	1"1/2	NR	1	6	04	62,50
● 1541006	2"	NR	1	4	04	96,04

RACCORDERIA IN RAME-BRONZO

RACCORDERIA A BRASARE IN RAME

Conforme alle norme:

- UNI EN 1254-1; UNI EN 1254-4; UNI EN 1254-5
- I terminali filettati sono realizzati in accordo alla norma UNI EN 10226-1 e UNI EN ISO 228-1.
- Campi applicazione: acqua sanitaria, riscaldamento, aria condizionata e refrigerazione.

CURVA A 90° M/F



codice	sigla	Ø	UM	min. ord. conf.	cat.	prezzo (€)
6200003	5001A01000000	10	NR	10	07	4,13
6200004	5001A012000000	12	NR	10	07	2,00
6200005	5001A014000000	14	NR	10	07	1,51
6200007	5001A016000000	16	NR	10	07	1,68
6200008	5001A018000000	18	NR	10	07	2,00
6200010	5001A022000000	22	NR	10	07	2,77
6200012	5001A028000000	28	NR	10	07	6,97
6200014	5001A035000000	35	NR	2	07	20,58
6200016	5001A042000000	42	NR	2	07	31,71
6200018	5001A054000000	54	NR	1	07	53,83

CURVA A 90° F/F



codice	sigla	Ø	UM	min. ord. conf.	cat.	prezzo (€)
6201003	5002A010000000	10	NR	10	07	1,82
6201004	5002A012000000	12	NR	10	07	1,05
6201005	5002A014000000	14	NR	10	07	1,19
6201007	5002A016000000	16	NR	10	07	1,47
6201008	5002A018000000	18	NR	10	07	1,47
6201010	5002A022000000	22	NR	10	07	2,14
6201012	5002A028000000	28	NR	10	07	3,61
6201014	5002A035000000	35	NR	2	07	11,24
6201016	5002A042000000	42	NR	2	07	15,65
6201018	5002A054000000	54	NR	2	07	41,58

CURVA A 90° F, CON DADO FOLLE A SEDE PIANA



codice	sigla	Ø	UM	min. ord. conf.	cat.	prezzo (€)
6202002	5002G01200400P	12-1/2"	NR	25	07	5,36
6202003	5002G01400400P	14-1/2"	NR	25	07	5,36
6202006	5002G01600400P	16-1/2"	NR	25	07	5,67
6202007	5002G01600600P	16-3/4"	NR	25	07	6,76
6202008	5002G01800600P	18-3/4"	NR	25	07	6,83
6202009	5002G02200600P	22-3/4"	NR	25	07	8,79

CURVA A 45° M/F



codice	sigla	Ø	UM	min. ord. conf.	cat.	prezzo (€)
6203002	5040 010000000	10	NR	10	07	4,59
6203003	5040 012000000	12	NR	10	07	2,21
6203004	5040 014000000	14	NR	10	07	1,79
6203006	5040 016000000	16	NR	10	07	2,28
6203007	5040 018000000	18	NR	10	07	2,31
6203009	5040 022000000	22	NR	10	07	2,35
6203011	5040 028000000	28	NR	10	07	4,69
6203013	5040 035000000	35	NR	2	07	17,54
6203015	5040 042000000	42	NR	2	07	28,53
6203017	5040 054000000	54	NR	2	07	46,52

CURVA A 45° F/F



codice	sigla	Ø	UM	min. ord. conf.	cat.	prezzo (€)
6204003	5041 010000000	10	NR	10	07	4,66
6204004	5041 012000000	12	NR	10	07	2,28
6204005	5041 014000000	14	NR	10	07	1,47
6204007	5041 016000000	16	NR	10	07	1,72
6204008	5041 018000000	18	NR	10	07	2,24
6204010	5041 022000000	22	NR	10	07	2,56
6204012	5041 028000000	28	NR	10	07	4,59
6204014	5041 035000000	35	NR	2	07	15,93
6204016	5041 042000000	42	NR	2	07	26,04
6204018	5041 054000000	54	NR	2	07	46,52

RACCORDERIA IN RAME-BRONZO

RACCORDERIA A BRASARE IN RAME

SORPASSO F/F



codice	sigla	∅	UM	min. ord. conf.	cat.	prezzo (€)
6206002	5085 014000000	14	NR	10	07	10,99
6206004	5085 016000000	16	NR	10	07	12,29
6206005	5085 018000000	18	NR	10	07	14,42
6206006	5085 022000000	22	NR	10	07	19,60

SORPASSO M/F



codice	sigla	∅	UM	min. ord. conf.	cat.	prezzo (€)
6207002	5086 014000000	14	NR	10	07	8,51
6207004	5086 016000000	16	NR	10	07	11,27
6207005	5086 018000000	18	NR	10	07	11,90
6207006	5086 022000000	22	NR	10	07	16,63

GOMITO A 90° F/F



codice	sigla	∅	UM	min. ord. conf.	cat.	prezzo (€)
6208003	5090 010000000	10	NR	10	07	2,28
6208004	5090 012000000	12	NR	10	07	0,91
6208005	5090 014000000	14	NR	10	07	0,84
6208007	5090 016000000	16	NR	10	07	1,16
6208008	5090 018000000	18	NR	10	07	1,23
6208010	5090 022000000	22	NR	10	07	1,89
6208012	5090 028000000	28	NR	10	07	3,19
6208014	5090 035000000	35	NR	2	07	13,90
6208016	5090 042000000	42	NR	2	07	25,06
6208018	5090 054000000	54	NR	1	07	45,96

TEE F/F/F

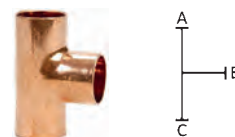

codice	sigla	A - B - C	UM	min. ord. conf.	cat.	prezzo (€)
6211003	5130 010010010	10-10-10	NR	10	07	3,61
6211004	5130 012012012	12-12-12	NR	10	07	1,54
6211005	5130 014014014	14-14-14	NR	10	07	1,37
6211007	5130 016016016	16-16-16	NR	10	07	1,75
6211008	5130 018018018	18-18-18	NR	10	07	2,59
6211009	5130 022022022	22-22-22	NR	10	07	3,64
6211012	5130 028028028	28-28-28	NR	10	07	7,14
6211013	5130 035035035	35-35-35	NR	2	07	20,65
6211014	5130 042042042	42-42-42	NR	2	07	39,03
6211016	5130 054054054	54-54-54	NR	1	07	62,69

GOMITO A 90° M/F



codice	sigla	∅	UM	min. ord. conf.	cat.	prezzo (€)
6210003	5092 010000000	10	NR	10	07	3,33
6210004	5092 012000000	12	NR	10	07	1,93
6210005	5092 014000000	14	NR	10	07	1,26
6210007	5092 016000000	16	NR	10	07	1,54
6210008	5092 018000000	18	NR	10	07	2,00
6210010	5092 022000000	22	NR	10	07	3,01
6210012	5092 028000000	28	NR	10	07	7,53
6210014	5092 035000000	35	NR	2	07	20,62
6210016	5092 042000000	42	NR	2	07	32,24
6210018	5092 054000000	54	NR	1	07	54,29

RACCORDERIA IN RAME-BRONZO

RACCORDERIA A BRASARE IN RAME

TEE RIDOTTO F/F/F

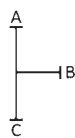

codice	sigla	A - B - C	UM	min. ord. conf.	cat.	prezzo (€)
6212025	5130 014012012	14-12-12	NR	10	07	3,05
6212026	5130 014012014	14-12-14	NR	10	07	2,56
6212048	5130 016012012	16-12-12	NR	10	07	4,41
6212050	5130 016012016	16-12-16	NR	10	07	3,61
6212053	5130 016014016	16-14-16	NR	10	07	3,12
6212061	5130 018012012	18-12-12	NR	10	07	11,76
6212065	5130 018012018	18-12-18	NR	10	07	7,11
6212067	5130 018014014	18-14-14	NR	10	07	6,69
6212068	5130 018014016	18-14-16	NR	10	07	6,02
6212069	5130 018014018	18-14-18	NR	10	07	3,57
6212074	5130 018016016	18-16-16	NR	10	07	6,37
6212075	5130 018016018	18-16-18	NR	10	07	5,85
6212077	5130 018018014	18-18-14	NR	10	07	6,27
6212081	5130 018022018	18-22-18	NR	10	07	10,33
6212088	5130 022012022	22-12-22	NR	10	07	10,75
6212089	5130 022014014	22-14-14	NR	10	07	10,64
6212091	5130 022014018	22-14-18	NR	10	07	11,31
6212092	5130 022014022	22-14-22	NR	10	07	5,67
6212098	5130 022016016	22-16-16	NR	10	07	10,12
6212099	5130 022016018	22-16-18	NR	10	07	10,47
6212100	5130 022016022	22-16-22	NR	10	07	5,92
6212101	5130 022018014	22-18-14	NR	10	07	8,75
6212104	5130 022018018	22-18-18	NR	10	07	7,81
6212105	5130 022018022	22-18-22	NR	10	07	5,01
6212107	5130 022022014	22-22-14	NR	10	07	10,01
6212110	5130 022022018	22-22-18	NR	10	07	11,38
6212111	5130 022028022	22-28-22	NR	10	07	19,22
6212112	5130 028012028	28-12-28	NR	10	07	22,30
6212113	5130 028014028	28-14-28	NR	10	07	16,38
6212119	5130 028016028	28-16-28	NR	10	07	15,47
6212123	5130 028018028	28-18-28	NR	10	07	12,92
6212127	5130 028022022	28-22-22	NR	10	07	15,23
6212128	5130 028022028	28-22-28	NR	10	07	8,37
6212133	5130 028028022	28-28-22	NR	10	07	19,15
6212143	5130 035022035	35-22-35	NR	2	07	23,59
6212147	5130 035028035	35-28-35	NR	2	07	31,33

MANICOTTO RIDOTTO F/F



codice	sigla	Ø	UM	min. ord. conf.	cat.	prezzo (€)
6222006	5240 014010000	14-10	NR	10	07	1,65
6222007	5240 014012000	14-12	NR	10	07	1,44
6222013	5240 016012000	16-12	NR	10	07	1,75
6222014	5240 016014000	16-14	NR	10	07	1,51
6222016	5240 018010000	18-10	NR	10	07	5,01
6222017	5240 018012000	18-12	NR	10	07	3,61
6222018	5240 018014000	18-14	NR	10	07	2,10
6222020	5240 018016000	18-16	NR	10	07	2,42
6222022	5240 022014000	22-14	NR	10	07	3,33
6222024	5240 022016000	22-16	NR	10	07	3,99
6222025	5240 022018000	22-18	NR	10	07	3,19
6222032	5240 028018000	28-18	NR	10	07	7,35
6222033	5240 028022000	28-22	NR	10	07	4,27
6222041	5240 035022000	35-22	NR	2	07	13,90
6222042	5240 035028000	35-28	NR	2	07	17,54
6222050	5240 042035000	42-35	NR	2	07	19,67

MANICOTTO RIDOTTO M/F



codice	sigla	Ø	UM	min. ord. conf.	cat.	prezzo (€)
6224006	5243 012010000	12-10	NR	10	07	2,49
6224008	5243 014012000	14-12	NR	10	07	1,23
6224014	5243 016012000	16-12	NR	10	07	1,61
6224015	5243 016014000	16-14	NR	10	07	1,23
6224017	5243 018012000	18-12	NR	10	07	2,73
6224018	5243 018014000	18-14	NR	10	07	1,79
6224020	5243 018016000	18-16	NR	10	07	1,96
6224022	5243 022012000	22-12	NR	10	07	5,64
6224023	5243 022014000	22-14	NR	10	07	2,84
6224025	5243 022016000	22-16	NR	10	07	2,28
6224026	5243 022018000	22-18	NR	10	07	1,89
6224031	5243 028012000	28-12	NR	10	07	12,50
6224032	5243 028014000	28-14	NR	10	07	8,09
6224034	5243 028016000	28-16	NR	10	07	8,33
6224035	5243 028018000	28-18	NR	10	07	6,44
6224036	5243 028022000	28-22	NR	10	07	3,01
6224041	5243 035022000	35-22	NR	2	07	13,02
6224042	5243 035028000	35-28	NR	2	07	9,56
6224046	5243 042022000	42-22	NR	1	07	21,46
6224047	5243 042028000	42-28	NR	2	07	19,46
6224048	5243 042035000	42-35	NR	2	07	16,45
6224052	5243 054028000	54-28	NR	1	07	36,89
6224053	5243 054035000	54-35	NR	2	07	38,08
6224054	5243 054042000	54-42	NR	2	07	30,91

RACCORDERIA IN RAME-BRONZO

RACCORDERIA A BRASARE IN RAME

MANICOTTO CON BATTUTA F/F



codice	sigla	Ø	UM	min. ord. conf.	cat.	prezzo (€)
6226002	5270 008000000	8	NR	10	07	1,58
6226003	5270 010000000	10	NR	10	07	0,60
6226004	5270 012000000	12	NR	10	07	0,42
6226005	5270 014000000	14	NR	10	07	0,46
6226007	5270 016000000	16	NR	10	07	0,60
6226008	5270 018000000	18	NR	10	07	0,74
6226010	5270 022000000	22	NR	10	07	1,02
6226012	5270 028000000	28	NR	10	07	2,14
6226014	5270 035000000	35	NR	10	07	5,32
6226016	5270 042000000	42	NR	2	07	9,70
6226017	5270 054000000	54	NR	2	07	16,45

CALOTTA F



codice	sigla	Ø	UM	min. ord. conf.	cat.	prezzo (€)
6229003	5301 010000000	10	NR	10	07	2,70
6229004	5301 012000000	12	NR	10	07	2,07
6229005	5301 014000000	14	NR	10	07	1,96
6229007	5301 016000000	16	NR	10	07	2,03
6229008	5301 018000000	18	NR	10	07	2,28
6229009	5301 022000000	22	NR	10	07	3,47
6229010	5301 028000000	28	NR	10	07	4,76
6229011	5301 035000000	35	NR	1	07	14,91
6229012	5301 042000000	42	NR	1	07	24,96
6229013	5301 054000000	54	NR	1	07	35,63

CODOLO F, CON DADO FOLLE E SEDE PIANA



codice	sigla	Ø	UM	min. ord. conf.	cat.	prezzo (€)
6231003	5359G01200400P	12-1/2"	NR	25	07	3,12
6231004	5359G01400400P	14-1/2"	NR	25	07	3,33
6231005	5359G01400600P	14-3/4"	NR	25	07	5,04
6231006	5359G01600400P	16-1/2"	NR	25	07	3,15
6231007	5359G01600600P	16-3/4"	NR	25	07	4,97
6231008	5359G01800600P	18-3/4"	NR	25	07	5,08
6231009	5359G02200600P	22-3/4"	NR	25	07	5,22
6231010	5359G02200800P	22-1"	NR	10	07	10,12

RACCORDERIA IN RAME-BRONZO

RACCORDERIA A BRASARE ED AVVITARE IN BRONZO

Conforme alle norme:

- UNI EN 1254-1; UNI EN 1254-4; UNI EN 1254-5
- I terminali filettati sono realizzati in accordo alla norma UNI EN 10226-1 e UNI ISO 228-1.
- Campi applicazione: acqua sanitaria, riscaldamento, aria condizionata e refrigerazione.

GOMITO A 90° F/FILETTO F



codice	sigla	Ø	UM	min. ord. conf.	cat.	prezzo (€)
6402005	4090G012004000	12x1/2"	NR	10	02	3,74
6402007	4090G014004000	14x1/2"	NR	10	02	3,84
6402013	4090G016004000	16x1/2"	NR	10	02	4,15
6402015	4090G018004000	18x1/2"	NR	10	02	4,56
6402016	4090G018006000	18x3/4"	NR	10	02	6,39
6402017	4090G022004000	22x1/2"	NR	10	02	7,79
6402018	4090G022006000	22x3/4"	NR	10	02	7,31
6402019	4090G022008000	22x1"	NR	10	02	14,14
6402020	4090G028006000	28x3/4"	NR	10	02	14,76
6402021	4090G028008000	28x1"	NR	10	02	19,92
6402022	4090G035008000	35x1"	NR	1	02	28,49
6402023	4090G035010000	35x1"1/4	NR	1	02	34,85

GOMITO A 90° F/FILETTO M



codice	sigla	Ø	UM	min. ord. conf.	cat.	prezzo (€)
6403006	4092G012004000	12x1/2"	NR	10	02	5,41
6403008	4092G014004000	14x1/2"	NR	10	02	5,03
6403012	4092G016004000	16x1/2"	NR	10	02	5,92
6403014	4092G018004000	18x1/2"	NR	10	02	6,77
6403015	4092G018006000	18x3/4"	NR	10	02	10,74
6403016	4092G022004000	22x1/2"	NR	10	02	12,92
6403017	4092G022006000	22x3/4"	NR	10	02	10,20
6403020	4092G028008000	28x1"	NR	10	02	19,92
6403021	4092G035010000	35x1"1/4	NR	1	02	54,09

MANICOTTO F/FILETTO M



codice	sigla	Ø	UM	min. ord. conf.	cat.	prezzo (€)
6410004	4243G010003000	10x3/8"	NR	10	02	2,79
6410005	4243G010004000	10x1/2"	NR	10	02	3,26
6410007	4243G012003000	12x3/8"	NR	10	02	2,14
6410008	4243G012004000	12x1/2"	NR	10	02	2,52
6410009	4243G014003000	14x3/8"	NR	10	02	2,62
6410010	4243G014004000	14x1/2"	NR	10	02	2,04
6410011	4243G014006000	14x3/4"	NR	10	02	5,54
6410016	4243G016004000	16x1/2"	NR	10	02	2,55
6410017	4243G016006000	16x3/4"	NR	10	02	3,81
6410018	4243G018004000	18x1/2"	NR	10	02	2,99
6410019	4243G018006000	18x3/4"	NR	10	02	3,13
6410020	4243G022004000	22x1/2"	NR	10	02	4,79
6410021	4243G022006000	22x3/4"	NR	10	02	3,71
6410022	4243G022008000	22x1"	NR	10	02	5,51
6410024	4243G028006000	28x3/4"	NR	10	02	7,45
6410025	4243G028008000	28x1"	NR	10	02	5,58
6410026	4243G028010000	28x1"1/4	NR	1	02	12,21
6410027	4243G035008000	35x1"	NR	1	02	12,24
6410028	4243G035010000	35x1"1/4	NR	10	02	9,89
6410030	4243G042010000	42x1"1/4	NR	1	02	26,18
6410031	4243G042012000	42x1"1/2	NR	1	02	22,10
6410033	4243G054012000	54x1"1/2	NR	1	02	50,12
6410034	4243G054016000	54x2"	NR	1	02	46,10

BOCCHETT. A 90° F/FILETTO M, A TENUTA METALL.



codice	sigla	Ø	UM	min. ord. conf.	cat.	prezzo (€)
6406012	4098G018006000	18x3/4"	NR	10	02	27,30
6406013	4098G022006000	22x3/4"	NR	10	02	26,76

TEE F FILETTO F/F



codice	sigla	Ø	UM	min. ord. conf.	cat.	prezzo (€)
6407004	4130G012004012	12x1/2"x12	NR	10	02	6,19
6407006	4130G014004014	14x1/2"x14	NR	10	02	6,26
6407011	4130G016004016	16x1/2"x16	NR	10	02	6,90
6407014	4130G018004018	18x1/2"x18	NR	10	02	7,89
6407015	4130G018006018	18x3/4"x18	NR	10	02	11,12
6407017	4130G022004022	22x1/2"x22	NR	10	02	9,52
6407018	4130G022006022	22x3/4"x22	NR	10	02	14,25
6407019	4130G028004028	28x1/2"x28	NR	10	02	17,75
6407020	4130G028006028	28x3/4"x28	NR	10	02	14,72
6407021	4130G028008028	28x1"x28	NR	10	02	26,93

RACCORDERIA IN RAME-BRONZO

RACCORDERIA A BRASARE ED AVVITARE IN BRONZO

MANICOTTO F/FILETTO F



codice	sigla	Ø	UM	min. ord. conf.	cat.	prezzo (€)
6412004	4270G010004000	10x1/2"	NR	10	02	6,22
6412005	4270G012003000	12x3/8"	NR	10	02	3,23
6412006	4270G012004000	12x1/2"	NR	10	02	3,77
6412007	4270G014003000	14x3/8"	NR	10	02	3,91
6412008	4270G014004000	14x1/2"	NR	10	02	3,77
6412014	4270G016004000	16x1/2"	NR	10	02	3,84
6412015	4270G016006000	16x3/4"	NR	10	02	6,97
6412016	4270G018004000	18x1/2"	NR	10	02	3,64
6412017	4270G018006000	18x3/4"	NR	10	02	5,10
6412018	4270G022004000	22x1/2"	NR	10	02	5,34
6412019	4270G022006000	22x3/4"	NR	10	02	5,64
6412020	4270G022008000	22x1"	NR	10	02	8,74
6412022	4270G028006000	28x3/4"	NR	10	02	9,35
6412023	4270G028008000	28x1"	NR	10	02	10,13
6412026	4270G035008000	35x1"	NR	1	02	15,61
6412027	4270G035010000	35x1"1/4	NR	1	02	17,51
6412029	4270G042010000	42x1"1/4	NR	1	02	29,72
6412030	4270G042012000	42x1"1/2	NR	1	02	31,18
6412031	4270G054012000	54x1"1/2	NR	1	02	42,02
6412032	4270G054016000	54x2"	NR	1	02	53,21

BOCCHETTONE F/FILETTO F, A TENUTA METALLICA



codice	sigla	Ø	UM	min. ord. conf.	cat.	prezzo (€)
6419011	4340G016004000	16x1/2"	NR	10	02	15,47
6419014	4340G018006000	18x3/4"	NR	10	02	18,63
6419015	4340G022006000	22x3/4"	NR	10	02	20,88
6419016	4340G022008000	22x1"	NR	10	02	25,67
6419017	4340G028006000	28x3/4"	NR	10	02	34,48
6419018	4340G028008000	28x1"	NR	10	02	33,56

BOCCHETTONE F/FILETTO M, A TENUTA METALLICA



codice	sigla	Ø	UM	min. ord. conf.	cat.	prezzo (€)
6420005	4341G014004000	14x1/2"	NR	10	02	11,46
6420010	4341G016004000	16x1/2"	NR	10	02	11,83
6420011	4341G016006000	16x3/4"	NR	10	02	23,80
6420012	4341G018004000	18x1/2"	NR	10	02	13,94
6420013	4341G018006000	18x3/4"	NR	10	02	16,59
6420014	4341G022004000	22x1/2"	NR	10	02	21,49
6420015	4341G022006000	22x3/4"	NR	10	02	16,59
6420016	4341G022008000	22x1"	NR	10	02	33,12
6420017	4341G028008000	28x1"	NR	10	02	31,35
6420018	4341G035010000	35x1"1/4	NR	1	02	53,72

BOCCHETTONE F/FILETTO M SEDE PIANA C/GUARNIZIONE

Solo per acqua



codice	sigla	Ø	UM	min. ord. conf.	cat.	prezzo (€)
6417008	4331G022006000	22x3/4"	NR	10	02	18,46
6417009	4331G028008000	35x1"1/4	NR	10	02	28,22

GOMITO A 90° F/FILETTO F, C/FLANGIA A 3 FORI DI FISSAGGIO



codice	sigla	Ø	UM	min. ord. conf.	cat.	prezzo (€)
6430004	4471G012004000	12x1/2"	NR	10	02	8,19
6430006	4471G014004000	14x1/2"	NR	10	02	8,16
6430009	4471G016004000	16x1/2"	NR	10	02	10,74

GOMITO A 90° F/FILETTO F, C/FLANGIA A 2 FORI DI FISSAGGIO



codice	sigla	Ø	UM	min. ord. conf.	cat.	prezzo (€)
6431002	4472G012004000	12x1/2"	NR	10	02	4,45
6431004	4472G014004000	14x1/2"	NR	10	02	4,83
6431009	4472G016004000	16x1/2"	NR	10	02	5,34
6431010	4472G018004000	18x1/2"	NR	10	02	7,14
6431011	4472G022006000	22x3/4"	NR	10	02	11,90

RACCORDERIA IN RAME-BRONZO

RACCORDERIA A PRESSARE RAME PER ACQUA E GAS



RACCORDO UNICO PER ACQUA E PER GAS

Conforme alla norma EN 1254-7

Doppia marcatura blu e gialla

Elastomero in HNBR giallo secondo EN549 e EN681-1

Profilo di pressatura V

Raccorderia a pressione utilizzabile per acqua sanitaria, riscaldamento, raffrescamento, aria compressa (priva di oli), Gas metano, GPL e olio combustibile.

CURVA 90° F/F



codice	sigla	Ø	UM	min. ord. conf.	cat.	prezzo (€)
6771001	P15002 01200000	12	NR	10	01	5,78
6771002	P15002 01500000	15	NR	10	01	5,15
6771003	P15002 01800000	18	NR	10	01	6,40
6771004	P15002 02200000	22	NR	10	01	8,02
6771005	P15002 02800000	28	NR	5	01	15,81
6771006	P15002 03500000	35	NR	5	01	29,54
6771007	P15002 04200000	42	NR	5	01	54,05
6771008	P15002 05400000	54	NR	1	01	74,84

CURVA 90° M/F



codice	sigla	Ø	UM	min. ord. conf.	cat.	prezzo (€)
6770001	P15001 01200000	12	NR	10	01	5,18
6770002	P15001 01500000	15	NR	10	01	4,59
6770003	P15001 01800000	18	NR	10	01	5,84
6770004	P15001 02200000	22	NR	10	01	7,72
6770005	P15001 02800000	28	NR	5	01	16,67
6770006	P15001 03500000	35	NR	5	01	28,58
6770007	P15001 04200000	42	NR	5	01	56,30
6770008	P15001 05400000	54	NR	1	01	75,34

CURVA 45° F/F



codice	sigla	Ø	UM	min. ord. conf.	cat.	prezzo (€)
6773001	P15041 01200000	12	NR	10	01	6,47
6773002	P15041 01500000	15	NR	10	01	5,71
6773003	P15041 01800000	18	NR	10	01	6,30
6773004	P15041 02200000	22	NR	10	01	7,49
6773005	P15041 02800000	28	NR	5	01	20,43
6773006	P15041 03500000	35	NR	5	01	28,48
6773007	P15041 04200000	42	NR	5	01	45,08
6773008	P15041 05400000	54	NR	1	01	62,90

CURVA 45° M/F



codice	sigla	Ø	UM	min. ord. conf.	cat.	prezzo (€)
6772001	P15040 01200000	12	NR	10	01	5,12
6772002	P15040 01500000	15	NR	10	01	4,49
6772003	P15040 01800000	18	NR	10	01	5,71
6772004	P15040 02200000	22	NR	10	01	6,70
6772005	P15040 02800000	28	NR	5	01	19,04
6772006	P15040 03500000	35	NR	5	01	26,20
6772007	P15040 04200000	42	NR	5	01	41,75
6772008	P15040 05400000	54	NR	1	01	61,81

TEE



codice	sigla	Ø	UM	min. ord. conf.	cat.	prezzo (€)
6774001	P15130 01212012	12	NR	10	01	12,74
6774002	P15130 01515015	15	NR	10	01	7,69
6774003	P15130 01818018	18	NR	10	01	9,90
6774004	P15130 02222022	22	NR	10	01	13,04
6774005	P15130 02828028	28	NR	5	01	21,55
6774006	P15130 03535035	35	NR	1	01	34,88
6774007	P15130 04242042	42	NR	1	01	66,13
6774008	P15130 05454054	54	NR	1	01	82,17

RACCORDERIA IN RAME-BRONZO

RACCORDERIA A PRESSURE RAME PER ACQUA E GAS

TEE RIDOTTO



codice	sigla	Ø	UM	min. ord. conf.	cat.	prezzo (€)
6775001	P15130 01512015	15-12-15	NR	10	01	22,47
6775002	P15130 01812018	18-12-18	NR	5	01	17,56
6775003	P15130 01815018	18-15-18	NR	10	01	10,40
6775004	P15130 02215022	22-15-22	NR	5	01	11,81
6775005	P15130 02218022	22-18-22	NR	5	01	13,00
6775006	P15130 02815028	28-15-28	NR	5	01	24,75
6775007	P15130 02818028	28-18-28	NR	5	01	32,01
6775008	P15130 02822028	28-22-28	NR	5	01	25,01
6775009	P15130 03518035	35-18-35	NR	1	01	40,99
6775010	P15130 03522035	35-22-35	NR	1	01	32,18
6775011	P15130 03528035	35-28-35	NR	1	01	34,06
6775012	P15130 04222042	42-22-42	NR	1	01	67,88
6775013	P15130 04228042	42-28-42	NR	1	01	60,32
6775014	P15130 04235042	42-35-42	NR	1	01	62,47
6775015	P15130 05428054	54-28-54	NR	1	01	86,46
6775016	P15130 05435054	54-35-54	NR	1	01	90,88
6775017	P15130 05442054	54-42-54	NR	1	01	78,47

MANICOTTO RIDOTTO M/F



codice	sigla	Ø	UM	min. ord. conf.	cat.	prezzo (€)
6778001	P15243 01512000	15-12	NR	10	01	4,06
6778002	P15243 01812000	18-12	NR	10	01	5,81
6778003	P15243 01815000	18-15	NR	10	01	4,65
6778004	P15243 02215000	22-15	NR	10	01	4,92
6778005	P15243 02218000	22-18	NR	10	01	5,15
6778006	P15243 02815000	28-15	NR	5	01	11,95
6778007	P15243 02818000	28-18	NR	10	01	12,14
6778008	P15243 02822000	28-22	NR	10	01	12,57
6778009	P15243 03522000	35-22	NR	5	01	15,11
6778010	P15243 03528000	35-28	NR	1	01	16,01
6778011	P15243 04222000	42-22	NR	1	01	23,99
6778012	P15243 04228000	42-28	NR	1	01	23,43
6778013	P15243 04235000	42-35	NR	1	01	22,97
6778014	P15243 05435000	54-35	NR	1	01	31,48
6778015	P15243 05442000	54-42	NR	1	01	30,06

TEE RIDOTTO CENTRALE/LATERALE



codice	sigla	Ø	UM	min. ord. conf.	cat.	prezzo (€)
6776001	P15130 01815015	18-15-15	NR	10	01	21,32
6776002	P15130 02222015	22-22-15	NR	10	01	18,81

MANICOTTO CON BATTUTA F/F



codice	sigla	Ø	UM	min. ord. conf.	cat.	prezzo (€)
6779001	P15270 01200000	12	NR	10	01	5,15
6779002	P15270 01500000	15	NR	10	01	5,15
6779003	P15270 01800000	18	NR	10	01	6,24
6779004	P15270 02200000	22	NR	10	01	7,49
6779005	P15270 02800000	28	NR	5	01	13,30
6779006	P15270 03500000	35	NR	1	01	16,24
6779007	P15270 04200000	42	NR	1	01	28,28
6779008	P15270 05400000	54	NR	1	01	35,94

MANICOTTO RIDOTTO F/F



codice	sigla	Ø	UM	min. ord. conf.	cat.	prezzo (€)
6777001	P15240 01512000	15-12	NR	10	01	16,67
6777002	P15240 01815000	18-15	NR	10	01	18,38
6777003	P15240 02215000	22-15	NR	10	01	20,10
6777004	P15240 02218000	22-18	NR	10	01	20,49
6777005	P15240 02822000	28-22	NR	5	01	23,03
6777006	P15240 03528000	35-28	NR	5	01	32,37
6777007	P15240 04235000	42-35	NR	1	01	48,21
6777008	P15240 05442000	54-42	NR	1	01	52,50

TAPPO F



codice	sigla	Ø	UM	min. ord. conf.	cat.	prezzo (€)
6780001	P15301 01200000	12	NR	10	01	11,95
6780002	P15301 01500000	15	NR	10	01	9,67
6780003	P15301 01800000	18	NR	10	01	12,18
6780004	P15301 02200000	22	NR	10	01	15,54
6780005	P15301 02800000	28	NR	5	01	23,40
6780006	P15301 03500000	35	NR	1	01	26,20
6780007	P15301 04200000	42	NR	1	01	39,20
6780008	P15301 05400000	54	NR	1	01	49,86

RACCORDERIA IN RAME-BRONZO

RACCORDERIA A PRESSURE BRONZO PER ACQUA E GAS

GOMITO A 90° F/FILETTATO F



codice	sigla	Ø	UM	min. ord. conf.	cat.	prezzo (€)
6791001	P14090G01204000	12 x1/2"	NR	5	01	17,00
6791002	P14090G01504000	15 x1/2"	NR	5	01	13,20
6791003	P14090G01804000	18 x1/2"	NR	10	01	28,64
6791004	P14090G01806000	18 x3/4"	NR	5	01	32,41
6791005	P14090G02204000	22 x1/2"	NR	5	01	33,99
6791006	P14090G02206000	22 x3/4"	NR	5	01	20,92
6791007	P14090G02208000	22 x1"	NR	5	01	32,67
6791008	P14090G02808000	28 x1"	NR	5	01	36,37
6791009	P14090G03510000	35 x1"1/4	NR	1	01	61,71
6791010	P14090G04212000	42 x1"1/2	NR	1	01	80,85
6791011	P14090G05416000	54 x2"	NR	1	01	126,65

CURVA 90° F/FILETTATA M



codice	sigla	Ø	UM	min. ord. conf.	cat.	prezzo (€)
6790001	P14001G01504000	15 x1/2"	NR	10	01	20,82
6790002	P14001G01804000	18 x1/2"	NR	5	01	32,24
6790003	P14001G01806000	18 x3/4"	NR	5	01	32,37
6790004	P14001G02206000	22 x3/4"	NR	5	01	33,96
6790005	P14001G02808000	28 x1"	NR	5	01	50,03
6790006	P14001G03510000	35 x1"1/4	NR	1	01	66,79
6790007	P14001G04212000	42 x1"1/2	NR	1	01	92,83
6790008	P14001G05416000	54 x2"	NR	1	01	130,52

MANICOTTO F/FILETTATO M



codice	sigla	Ø	UM	min. ord. conf.	cat.	prezzo (€)
6793001	P14243G01204000	12 x1/2"	NR	5	01	8,28
6793002	P14243G01504000	15 x1/2"	NR	5	01	5,05
6793003	P14243G01506000	15 x3/4"	NR	5	01	9,80
6793004	P14243G01804000	18 x1/2"	NR	5	01	6,53
6793005	P14243G01806000	18 x3/4"	NR	5	01	8,09
6793006	P14243G02204000	22 x1/2"	NR	5	01	10,59
6793007	P14243G02206000	22 x3/4"	NR	5	01	10,26
6793008	P14243G02208000	22 x1"	NR	5	01	12,51
6793009	P14243G02806000	28 x3/4"	NR	5	01	25,51
6793010	P14243G02808000	28 x1"	NR	5	01	16,27
6793011	P14243G02810000	28 x1"1/4	NR	5	01	31,81
6793012	P14243G03508000	35 x1"	NR	5	01	35,90
6793013	P14243G03510000	35 x1"1/4	NR	1	01	35,54
6793014	P14243G04210000	42 x1"1/4	NR	1	01	49,90
6793015	P14243G04212000	42 x1"1/2	NR	1	01	51,25
6793016	P14243G05416000	54 x2"	NR	1	01	95,30

MANICOTTO F/FILETTATO F



codice	sigla	Ø	UM	min. ord. conf.	cat.	prezzo (€)
6794001	P14270G01204000	12 x1/2"	NR	5	01	9,70
6794002	P14270G01504000	15 x1/2"	NR	5	01	6,47
6794003	P14270G01506000	15 x3/4"	NR	5	01	11,81
6794004	P14270G01804000	18 x1/2"	NR	5	01	8,25
6794005	P14270G01806000	18 x3/4"	NR	5	01	15,48
6794006	P14270G02204000	22 x1/2"	NR	5	01	9,77
6794007	P14270G02206000	22 x3/4"	NR	5	01	10,30
6794008	P14270G02208000	22 x1"	NR	5	01	14,52
6794009	P14270G02806000	28 x3/4"	NR	5	01	29,70
6794010	P14270G02808000	28 x1"	NR	5	01	17,52
6794011	P14270G03508000	35 x1"	NR	5	01	38,61
6794012	P14270G03510000	35 x1"1/4	NR	1	01	38,84
6794013	P14270G04210000	42 x1"1/4	NR	1	01	53,92
6794014	P14270G04212000	42 x1"1/2	NR	1	01	57,45
6794015	P14270G05416000	54 x2"	NR	1	01	97,75

RACCORDERIA IN RAME-BRONZO

RACCORDERIA A PRESSARE BRONZO PER ACQUA E GAS

TEE F/FILETTATO F



codice	sigla	Ø	UM	min. ord. conf.	cat.	prezzo (€)
6792001	P14130G01504015	15 x1/2"	NR	5	01	20,56
6792002	P14130G01804018	18 x1/2"	NR	5	01	34,35
6792003	P14130G02204022	22 x1/2"	NR	5	01	27,95
6792004	P14130G02206022	22 x3/4"	NR	5	01	40,49
6792005	P14130G02804028	28 x1/2"	NR	5	01	35,31
6792006	P14130G02806028	28 x3/4"	NR	5	01	46,10
6792007	P14130G03504035	35 x1/2"	NR	1	01	49,63
6792008	P14130G04204042	42 x1/2"	NR	1	01	59,93
6792009	P14130G05404054	54 x1/2"	NR	1	01	85,14

GOMITO 90° F/FILETTATO F, CON FLANGIA 3 FORI



codice	sigla	Ø	UM	min. ord. conf.	cat.	prezzo (€)
6795001	P14471G01504000	15x1/2"	NR	5	01	14,42
6795002	P14471G01804000	18x1/2"	NR	5	01	24,02
6795003	P14471G02206000	22x3/4"	NR	5	01	40,16

RACCORDERIA IN RAME-BRONZO

RACCORDERIA A PRESSARE RAME ACQUA



Conforme alla norma UNI 11065

Elastomero in EPDM per l'acqua (UNI EN 681-1)

- Misure disponibili profilo "V": 12-54 (mm.)
- Misure disponibili profilo "XL": 64-108 (mm.).

La raccorderia a pressare per acqua è utilizzabile nelle installazioni per il trasporto e distribuzione di acque destinate al consumo umano, nell'impiantistica civile e industriale.

CURVA A 90° F/F



codice	sigla	Ø	UM	min. ord. conf.	cat.	prezzo (€)
6638001	P5002 01200000	12	NR	10	01	4,13
6638002	P5002 01500000	15	NR	10	01	4,06
6638003	P5002 01800000	18	NR	10	01	5,31
6638004	P5002 02200000	22	NR	10	01	6,80
6638005	P5002 02800000	28	NR	5	01	13,79
6638006	P5002 03500000	35	NR	5	01	28,28
6638007	P5002 04200000	42	NR	5	01	53,89
6638008	P5002 05400000	54	NR	1	01	74,55

CURVA A 90° M/F



codice	sigla	Ø	UM	min. ord. conf.	cat.	prezzo (€)
6637001	P5001 01200000	12	NR	10	01	3,83
6637002	P5001 01500000	15	NR	10	01	3,83
6637003	P5001 01800000	18	NR	10	01	5,18
6637004	P5001 02200000	22	NR	10	01	6,77
6637005	P5001 02800000	28	NR	5	01	15,44
6637006	P5001 03500000	35	NR	5	01	28,55
6637007	P5001 04200000	42	NR	5	01	56,33
6637008	P5001 05400000	54	NR	1	01	75,44

CURVA A 45° F/F



codice	sigla	Ø	UM	min. ord. conf.	cat.	prezzo (€)
6640001	P5041 01200000	12	NR	10	01	4,59
6640002	P5041 01500000	15	NR	10	01	4,62
6640003	P5041 01800000	18	NR	10	01	4,75
6640004	P5041 02200000	22	NR	10	01	5,97
6640005	P5041 02800000	28	NR	5	01	18,91
6640006	P5041 03500000	35	NR	5	01	27,19
6640007	P5041 04200000	42	NR	5	01	44,32
6640008	P5041 05400000	54	NR	1	01	62,01

CURVA A 45° M/F



codice	sigla	Ø	UM	min. ord. conf.	cat.	prezzo (€)
6639001	P5040 01200000	12	NR	10	01	3,63
6639002	P5040 01500000	15	NR	10	01	3,76
6639003	P5040 01800000	18	NR	10	01	4,79
6639004	P5040 02200000	22	NR	10	01	5,51
6639005	P5040 02800000	28	NR	5	01	18,45
6639006	P5040 03500000	35	NR	5	01	26,33
6639007	P5040 04200000	42	NR	5	01	41,25
6639008	P5040 05400000	54	NR	1	01	61,15

TEE F/F/F



codice	sigla	Ø	UM	min. ord. conf.	cat.	prezzo (€)
6643001	P5130 01212012	12	NR	10	01	6,73
6643006	P5130 01515015	15	NR	10	01	6,96
6643013	P5130 01818018	18	NR	10	01	9,34
6643024	P5130 02222022	22	NR	10	01	12,08
6643035	P5130 02828028	28	NR	5	01	20,06
6643042	P5130 03535035	35	NR	1	01	33,89
6643047	P5130 04242042	42	NR	1	01	65,97
6643053	P5130 05454054	54	NR	1	01	81,44

RACCORDERIA IN RAME-BRONZO

RACCORDERIA A PRESSARE RAME ACQUA

TEE RIDOTTO F/F/F



codice	sigla	Ø	UM	min. ord. conf.	cat.	prezzo (€)
6643004	P5130 01512015	15-12-15	NR	10	01	7,89
6643005	P5130 01515012	15-15-12	NR	5	01	14,92
6643009	P5130 01812018	18-12-18	NR	5	01	8,94
6643011	P5130 01815018	18-15-18	NR	10	01	8,51
6643015	P5130 02212022	22-12-22	NR	10	01	11,45
6643018	P5130 02215022	22-15-22	NR	5	01	10,43
6643021	P5130 02218022	22-18-22	NR	5	01	12,11
6643027	P5130 02815028	28-15-28	NR	5	01	22,77
6643029	P5130 02818028	28-18-28	NR	5	01	31,48
6643030	P5130 02822022	28-22-22	NR	5	01	30,76
6643031	P5130 02822028	28-22-28	NR	5	01	22,70
6643037	P5130 03518035	35-18-35	NR	1	01	35,61
6643039	P5130 03522035	35-22-35	NR	1	01	30,89
6643041	P5130 03528035	35-28-35	NR	1	01	32,57
6643043	P5130 04222042	42-22-42	NR	1	01	59,04
6643044	P5130 04228042	42-28-42	NR	1	01	59,90
6643046	P5130 04235042	42-35-42	NR	1	01	62,01
6643048	P5130 05422054	54-22-54	NR	1	01	92,60
6643049	P5130 05428054	54-28-54	NR	1	01	95,47
6643050	P5130 05435054	54-35-54	NR	1	01	99,00

MANICOTTO RIDOTTO M/F



codice	sigla	Ø	UM	min. ord. conf.	cat.	prezzo (€)
6645001	P5243 01512000	15x12	NR	10	01	3,53
6645002	P5243 01812000	18x12	NR	10	01	3,56
6645003	P5243 01815000	18x15	NR	10	01	3,56
6645004	P5243 02215000	22x15	NR	10	01	4,22
6645005	P5243 02218000	22x18	NR	10	01	4,36
6645006	P5243 02815000	28x15	NR	5	01	10,76
6645007	P5243 02818000	28x18	NR	10	01	11,06
6645008	P5243 02822000	28x22	NR	10	01	11,29
6645009	P5243 03522000	35x22	NR	5	01	13,37
6645010	P5243 03528000	35x28	NR	1	01	14,69
6645011	P5243 04222000	42x22	NR	1	01	22,77
6645012	P5243 04228000	42x28	NR	1	01	22,21
6645013	P5243 04235000	42x35	NR	1	01	21,78
6645014	P5243 05435000	54x35	NR	1	01	30,29
6645015	P5243 05442000	54x42	NR	1	01	29,07

MANICOTTO RIDOTTO F/F



codice	sigla	Ø	UM	min. ord. conf.	cat.	prezzo (€)
6644001	P5240 01512000	15x12	NR	10	01	11,12
6644002	P5240 01815000	18x15	NR	10	01	15,97
6644003	P5240 02215000	22x15	NR	10	01	17,49
6644004	P5240 02218000	22x18	NR	10	01	17,82
6644005	P5240 02822000	28x22	NR	5	01	20,03
6644006	P5240 03528000	35x28	NR	5	01	28,15
6644007	P5240 04235000	42x35	NR	1	01	41,91
6644008	P5240 05442000	54x42	NR	1	01	46,89

MANICOTTO CON BATTUTA F/F



codice	sigla	Ø	UM	min. ord. conf.	cat.	prezzo (€)
6646001	P5270 01200000	12	NR	10	01	3,83
6646002	P5270 01500000	15	NR	10	01	3,93
6646003	P5270 01800000	18	NR	10	01	4,82
6646004	P5270 02200000	22	NR	10	01	5,91
6646005	P5270 02800000	28	NR	5	01	11,45
6646006	P5270 03500000	35	NR	1	01	14,19
6646007	P5270 04200000	42	NR	1	01	26,63
6646008	P5270 05400000	54	NR	1	01	33,56

TAPPO DI CHIUSURA F



codice	sigla	Ø	UM	min. ord. conf.	cat.	prezzo (€)
6648001	P5301 01200000	12	NR	10	01	8,32
6648002	P5301 01500000	15	NR	10	01	8,32
6648003	P5301 01800000	18	NR	10	01	10,56
6648004	P5301 02200000	22	NR	10	01	14,03
6648005	P5301 02800000	28	NR	5	01	21,62
6648006	P5301 03500000	35	NR	1	01	24,06
6648007	P5301 04200000	42	NR	1	01	37,39
6648008	P5301 05400000	54	NR	1	01	45,57

RACCORDERIA IN RAME-BRONZO

RACCORDERIA A PRESSARE BRONZO ACQUA



Conforme alle norme UNI 11065, UNI CIG 7129

Elastomero in EPDM per l'acqua (UNI EN 681-1)

- Misure disponibili profilo "V": 12-54 (mm.)
- Misure disponibili profilo "XL": 64-108 (mm.)

La raccorderia a pressione per acqua è utilizzabile nelle installazioni per il trasporto e distribuzione di acque destinate al consumo umano, nell'impiantistica civile, industriale e navale.

CURVA A 90° F/FILETTO M



codice	sigla	Ø	UM	min. ord. conf.	cat.	prezzo (€)
662002	P4001G01204000	12x1/2"	NR	5	01	20,69
662004	P4001G01504000	15x1/2"	NR	10	01	20,96
662005	P4001G01804000	18x1/2"	NR	5	01	32,31
662007	P4001G02206000	22x3/4"	NR	5	01	33,86
662008	P4001G02808000	28x1"	NR	5	01	50,95

GOMITO A 90° F/FILETTO F



codice	sigla	Ø	UM	min. ord. conf.	cat.	prezzo (€)
6621002	P4090G01204000	12x1/2"	NR	5	01	13,07
6621004	P4090G01504000	15x1/2"	NR	5	01	13,07
6621006	P4090G01804000	18x1/2"	NR	10	01	28,15
6621007	P4090G01806000	18x3/4"	NR	5	01	31,94
6621008	P4090G02204000	22x1/2"	NR	5	01	33,59
6621009	P4090G02206000	22x3/4"	NR	5	01	20,56
6621011	P4090G02808000	28x1"	NR	5	01	36,50
6621012	P4090G03510000	35x1"1/4	NR	1	01	61,84

TEE F/F/FILETTO F



codice	sigla	Ø	UM	min. ord. conf.	cat.	prezzo (€)
6624001	P4130G01204012	12x1/2"x12	NR	5	01	20,16
6624003	P4130G01504015	15x1/2"x15	NR	5	01	19,54
6624004	P4130G01804018	18x1/2"x18	NR	5	01	34,25
6624005	P4130G02204022	22x1/2"x22	NR	5	01	26,76
6624006	P4130G02206022	22x3/4"x22	NR	5	01	40,56
6624007	P4130G02804028	28x1/2"x28	NR	5	01	33,63
6624008	P4130G02806028	28x3/4"x28	NR	5	01	45,90
6624009	P4130G03504035	35x1/2"x35	NR	1	01	49,34

MANICOTTO F/FILETTO M



codice	sigla	Ø	UM	min. ord. conf.	cat.	prezzo (€)
6626002	P4243G01204000	12x1/2"	NR	5	01	4,88
6626004	P4243G01504000	15x1/2"	NR	5	01	4,62
6626005	P4243G01506000	15x3/4"	NR	5	01	9,11
6626006	P4243G01804000	18x1/2"	NR	5	01	5,74
6626007	P4243G01806000	18x3/4"	NR	5	01	6,93
6626008	P4243G02204000	22x1/2"	NR	5	01	9,37
6626009	P4243G02206000	22x3/4"	NR	5	01	8,55
6626010	P4243G02208000	22x1"	NR	5	01	11,52
6626011	P4243G02806000	28x3/4"	NR	5	01	25,38
6626012	P4243G02808000	28x1"	NR	5	01	15,58
6626014	P4243G03508000	35x1"	NR	5	01	35,05
6626015	P4243G03510000	35x1"1/4	NR	1	01	34,82
6626016	P4243G03512000	35x1"1/2	NR	1	01	37,52
6626017	P4243G04210000	42x1"1/4	NR	1	01	47,36
6626018	P4243G04212000	42x1"1/2	NR	1	01	48,58
6626020	P4243G05416000	54x2"	NR	1	01	93,65

RACCORDERIA IN RAME-BRONZO

RACCORDERIA A PRESSURE BRONZO ACQUA

MANICOTTO F/FILETTO F



codice	sigla	∅	UM	min. ord. conf.	cat.	prezzo (€)
6628002	P4270G01204000	12x1/2"	NR	5	01	6,07
6628004	P4270G01504000	15x1/2"	NR	5	01	5,74
6628006	P4270G01804000	18x1/2"	NR	5	01	7,56
6628007	P4270G01806000	18x3/4"	NR	5	01	14,78
6628008	P4270G02204000	22x1/2"	NR	5	01	8,55
6628009	P4270G02206000	22x3/4"	NR	5	01	9,14
6628010	P4270G02208000	22x1"	NR	5	01	13,46
6628011	P4270G02806000	28x3/4"	NR	5	01	29,70
6628012	P4270G02808000	28x1"	NR	5	01	16,73
6628013	P4270G02810000	28x1"1/4	NR	5	01	31,61
6628014	P4270G03508000	35x1"	NR	5	01	38,61
6628015	P4270G03510000	35x1"1/4	NR	1	01	38,15
6628016	P4270G04210000	42x1"1/4	NR	1	01	53,92
6628017	P4270G04212000	42x1"1/2	NR	1	01	55,14
6628018	P4270G05416000	54x2"	NR	1	01	96,13

MANICOTTO M/FILETTO F



codice	sigla	∅	UM	min. ord. conf.	cat.	prezzo (€)
6631001	P4281G01204000	12x1/2"	NR	5	01	16,70
6631002	P4281G01504000	15x1/2"	NR	5	01	18,05
6631003	P4281G01804000	18x1/2"	NR	5	01	18,05
6631004	P4281G01806000	18x3/4"	NR	5	01	18,58
6631005	P4281G02204000	22x1/2"	NR	5	01	22,47
6631006	P4281G02206000	22x3/4"	NR	5	01	26,73
6631007	P4281G02806000	28x3/4"	NR	5	01	40,03
6631008	P4281G02808000	28x1"	NR	5	01	40,89
6631009	P4281G03508000	35x1"	NR	1	01	56,96
6631010	P4281G03510000	35x1"1/4	NR	1	01	71,31

GOMITO A 90° F/FILETTO F, CON FLANGIA A 3 FORI DI FISSAGGIO



codice	sigla	∅	UM	min. ord. conf.	cat.	prezzo (€)
6636001	P4471G01204000	12x1/2"	NR	5	01	17,19
6636002	P4471G01504000	15x1/2"	NR	5	01	14,26
6636003	P4471G01804000	18x1/2"	NR	5	01	23,46
6636004	P4471G02206000	22x3/4"	NR	5	01	38,48

RACCORDERIA IN RAME-BRONZO

RACCORDERIA A PRESSARE RAME E BRONZO GAS



Conforme alla norma UNI 11065, UNI CIG 7129

Elastomero giallo in HNBR per gas (EN 549)

- Misure disponibili profilo "V": 15-54 (mm.)

Esternamente i raccordi riportano la scritta GAS ed una doppia striscia gialla di riconoscimento.

CURVA A 90° F/F



codice	sigla	Ø	UM	min. ord. conf.	cat.	prezzo (€)
6670001	PG5002 0150000	15	NR	10	01	5,41
6670002	PG5002 0180000	18	NR	10	01	6,73
6670003	PG5002 0220000	22	NR	10	01	8,45
6670004	PG5002 0280000	28	NR	5	01	16,63
6670005	PG5002 0350000	35	NR	5	01	31,09

CURVA A 90° M/F



codice	sigla	Ø	UM	min. ord. conf.	cat.	prezzo (€)
6669001	PG5001 0150000	15	NR	10	01	4,82
6669002	PG5001 0180000	18	NR	10	01	6,17
6669003	PG5001 0220000	22	NR	10	01	8,12
6669004	PG5001 0280000	28	NR	5	01	17,56
6669005	PG5001 0350000	35	NR	5	01	30,10

CURVA A 45° F/F



codice	sigla	Ø	UM	min. ord. conf.	cat.	prezzo (€)
6672001	PG5041 0150000	15	NR	10	01	6,04
6672002	PG5041 0180000	18	NR	10	01	6,63
6672003	PG5041 0220000	22	NR	10	01	7,89
6672004	PG5041 0280000	28	NR	5	01	21,48
6672005	PG5041 0350000	35	NR	5	01	30,00

CURVA A 45° M/F



codice	sigla	Ø	UM	min. ord. conf.	cat.	prezzo (€)
6671001	PG5040 0150000	15	NR	10	01	4,75
6671002	PG5040 0180000	18	NR	10	01	6,04
6671003	PG5040 0220000	22	NR	10	01	7,06
6671004	PG5040 0280000	28	NR	5	01	20,03
6671005	PG5040 0350000	35	NR	5	01	27,59

TEE F/F/F



codice	sigla	Ø	UM	min. ord. conf.	cat.	prezzo (€)
6673001	PG5130 0151515	15	NR	10	01	8,09
6673003	PG5130 0181818	18	NR	10	01	10,43
6673008	PG5130 0222222	22	NR	10	01	13,73
6673011	PG5130 0282828	28	NR	5	01	22,67
6673014	PG5130 0353535	35	NR	1	01	36,73

TEE RIDOTTO F/F/F



codice	sigla	Ø	UM	min. ord. conf.	cat.	prezzo (€)
6673002	PG5130 0181518	18-15-18	NR	10	01	10,96
6673005	PG5130 0221522	22-15-22	NR	10	01	12,41
6673006	PG5130 0221822	22-18-22	NR	10	01	13,66
6673007	PG5130 0222215	22-22-15	NR	10	01	19,80
6673009	PG5130 0281528	28-15-28	NR	5	01	26,04
6673010	PG5130 0282228	28-22-28	NR	5	01	26,33
6673012	PG5130 0352235	35-22-35	NR	1	01	33,89
6673013	PG5130 0352835	35-28-35	NR	1	01	35,84

MANICOTTO RIDOTTO M/F



codice	sigla	Ø	UM	min. ord. conf.	cat.	prezzo (€)
6674001	PG5243 0181500	18x15	NR	10	01	4,92
6674002	PG5243 0221500	22x15	NR	10	01	5,15
6674003	PG5243 0221800	22x18	NR	10	01	5,41
6674004	PG5243 0281500	28x15	NR	10	01	12,57
6674005	PG5243 0281800	28x18	NR	10	01	12,77
6674006	PG5243 0282200	28x22	NR	10	01	13,23
6674007	PG5243 0352200	35x22	NR	5	01	15,91
6674008	PG5243 0352800	35x28	NR	5	01	16,83

RACCORDERIA IN RAME-BRONZO

RACCORDERIA A PRESSURE RAME E BRONZO GAS

MANICOTTO CON BATTUTA F/F



codice	sigla	Ø	UM	min. ord. conf.	cat.	prezzo (€)
6675001	PG5270 0150000	15	NR	10	01	5,41
6675002	PG5270 0180000	18	NR	10	01	6,70
6675003	PG5270 0220000	22	NR	10	01	7,89
6675004	PG5270 0280000	28	NR	10	01	13,99
6675005	PG5270 0350000	35	NR	5	01	17,09

TAPPO DI CHIUSURA F



codice	sigla	Ø	UM	min. ord. conf.	cat.	prezzo (€)
6676001	PG5301 0150000	15	NR	10	01	10,20
6676002	PG5301 0180000	18	NR	10	01	12,80
6676003	PG5301 0220000	22	NR	10	01	16,37
6676004	PG5301 0280000	28	NR	10	01	24,62
6676005	PG5301 0350000	35	NR	5	01	27,59

CURVA A 90° F/FILETTO M



codice	sigla	Ø	UM	min. ord. conf.	cat.	prezzo (€)
6662001	PG4001G0150400	15x1/2"	NR	5	01	21,91
6662002	PG4001G0180400	18x1/2"	NR	5	01	33,96
6662003	PG4001G0180600	18x3/4"	NR	5	01	34,06
6662004	PG4001G0220600	22x3/4"	NR	5	01	35,77
6662005	PG4001G0280800	28x1"	NR	5	01	52,67

GOMITO A 90° F/FILETTO F



codice	sigla	Ø	UM	min. ord. conf.	cat.	prezzo (€)
6663001	PG4090G0150400	15x1/2"	NR	5	01	13,89
6663003	PG4090G0180400	18x1/2"	NR	5	01	30,13
6663004	PG4090G0180600	18x3/4"	NR	5	01	34,12
6663005	PG4090G0220400	22x1/2"	NR	5	01	35,77
6663006	PG4090G0220600	22x3/4"	NR	5	01	22,01
6663008	PG4090G0280800	28x1"	NR	5	01	38,28

TEE F/F/FILETTO F



codice	sigla	Ø	UM	min. ord. conf.	cat.	prezzo (€)
6664001	PG4130G0150415	15x1/2"x15	NR	5	01	21,62
6664002	PG4130G0180418	18x1/2"x18	NR	5	01	36,14
6664003	PG4130G0220422	22x1/2"x22	NR	5	01	29,40
6664004	PG4130G0220622	22x3/4"x22	NR	5	01	42,64
6664006	PG4130G0280628	28x3/4"x28	NR	5	01	48,54

MANICOTTO F/FILETTO M



codice	sigla	Ø	UM	min. ord. conf.	cat.	prezzo (€)
6665001	PG4243G0150400	15x1/2"	NR	5	01	5,31
6665002	PG4243G0150600	15x3/4"	NR	5	01	10,33
6665003	PG4243G0180400	18x1/2"	NR	5	01	6,90
6665004	PG4243G0180600	18x3/4"	NR	5	01	8,09
6665005	PG4243G0220400	22x1/2"	NR	5	01	11,15
6665006	PG4243G0220600	22x3/4"	NR	5	01	10,26
6665007	PG4243G0220800	22x1"	NR	5	01	13,17
6665008	PG4243G0280600	28x3/4"	NR	5	01	26,86
6665009	PG4243G0280800	28x1"	NR	5	01	17,13
6665011	PG4243G0350800	35x1"	NR	1	01	37,79
6665012	PG4243G0351000	35x1"1/4	NR	1	01	37,42
6665013	PG4243G0351200	35x1"1/2	NR	1	01	40,16

MANICOTTO F/FILETTO F



codice	sigla	Ø	UM	min. ord. conf.	cat.	prezzo (€)
6666001	PG4270G0150400	15x1/2"	NR	5	01	6,80
6666003	PG4270G0180400	18x1/2"	NR	5	01	8,68
6666004	PG4270G0180600	18x3/4"	NR	5	01	16,30
6666005	PG4270G0220400	22x1/2"	NR	5	01	10,30
6666006	PG4270G0220600	22x3/4"	NR	5	01	10,82
6666007	PG4270G0220800	22x1"	NR	5	01	13,89
6666008	PG4270G0280800	28x1"	NR	5	01	18,45
6666009	PG4270G0351000	35x1"1/4	NR	1	01	40,89

GOMITO A 90° F/FILETTO F, CON FLANGIA A 3 FORI DI FISSAGGIO



codice	sigla	Ø	UM	min. ord. conf.	cat.	prezzo (€)
6668001	PG4471G0150400	15x1/2"	NR	5	01	15,18
6668002	PG4471G0180400	18x1/2"	NR	5	01	25,31
6668003	PG4471G0220600	22x3/4"	NR	5	01	40,16

RACCORDERIA IN RAME-BRONZO

RACCORDERIA A PRESSURE IN RAME ARIA CONDIZIONATA E REFRIGERAZIONE



Conforme alla normativa EN 378-2
Elastomero in HNBR nero (EN549)

- Misure in pollici
- Profilo di pressatura BMP

Raccordi in rame per aria condizionata e refrigerazione fino a 48 bar, vuoto 200 micron, temperatura -40°C / +121°C.

CURVA A 90° M/F



codice	sigla	Ø	UM	min. ord. conf.	cat.	prezzo (€)
6750001	MPA5001 0030001	3/8"	NR	3	10	19,54
6750002	MPA5001 0040001	1/2"	NR	3	10	21,08
6750003	MPA5001 0050001	5/8"	NR	3	10	23,44
6750004	MPA5001 0060001	3/4"	NR	3	10	26,57
6750005	MPA5001 0070001	7/8"	NR	3	10	28,14
6750006	MPA5001 0080001	1"	NR	2	10	37,52
6750007	MPA5001 0090001	1"1/8	NR	2	10	39,06
6750008	MPA5001 0110001	1"3/8	NR	1	10	84,36

CURVA A 90° F/F



codice	sigla	Ø	UM	min. ord. conf.	cat.	prezzo (€)
6751001	MPA5002 0020001	1/4"	NR	5	10	24,22
6751002	MPA5002 0030001	3/8"	NR	5	10	25,00
6751003	MPA5002 0040001	1/2"	NR	3	10	26,57
6751004	MPA5002 0050001	5/8"	NR	3	10	29,29
6751005	MPA5002 0060001	3/4"	NR	3	10	32,42
6751006	MPA5002 0070001	7/8"	NR	3	10	33,60
6751007	MPA5002 0080001	1"	NR	2	10	35,95
6751008	MPA5002 0090001	1"1/8	NR	2	10	40,63
6751009	MPA5002 0110001	1"3/8	NR	1	10	60,26

CURVA A 45° F/F



codice	sigla	Ø	UM	min. ord. conf.	cat.	prezzo (€)
6752001	MPA5041 0020001	1/4"	NR	3	10	19,54
6752002	MPA5041 0030001	3/8"	NR	3	10	19,54
6752003	MPA5041 0040001	1/2"	NR	3	10	22,65
6752004	MPA5041 0050001	5/8"	NR	3	10	25,00
6752005	MPA5041 0060001	3/4"	NR	3	10	30,46
6752006	MPA5041 0070001	7/8"	NR	3	10	32,03
6752007	MPA5041 0080001	1"	NR	2	10	35,17
6752008	MPA5041 0090001	1"1/8	NR	2	10	37,52
6752009	MPA5041 0110001	1"3/8	NR	2	10	83,64

MANICOTTO CON BATTUTA F/F



codice	sigla	Ø	UM	min. ord. conf.	cat.	prezzo (€)
6756001	MPA5270 0020001	1/4"	NR	5	10	17,19
6756002	MPA5270 0030001	3/8"	NR	5	10	18,76
6756003	MPA5270 0040001	1/2"	NR	5	10	18,76
6756004	MPA5270 0050001	5/8"	NR	5	10	19,54
6756005	MPA5270 0060001	3/4"	NR	2	10	21,08
6756006	MPA5270 0070001	7/8"	NR	2	10	23,04
6756007	MPA5270 0080001	1"	NR	2	10	25,00
6756008	MPA5270 0090001	1"1/8	NR	2	10	28,14
6756009	MPA5270 0110001	1"3/8	NR	2	10	38,84

MANICOTTO PASSANTE F/F



codice	sigla	Ø	UM	min. ord. conf.	cat.	prezzo (€)
6758001	MPA5275L0020001	1/4"	NR	5	10	23,86
6758002	MPA5275L0030001	3/8"	NR	5	10	27,86
6758003	MPA5275L0040001	1/2"	NR	5	10	21,34
6758004	MPA5275L0050001	5/8"	NR	3	10	26,26
6758005	MPA5275L0060001	3/4"	NR	2	10	28,98
6758006	MPA5275L0070001	7/8"	NR	2	10	37,16
6758007	MPA5275L0080001	1"	NR	1	10	45,72
6758008	MPA5275L0090001	1"1/8	NR	1	10	51,02

RACCORDERIA IN RAME-BRONZO

RACCORDERIA A PRESSURE IN RAME ARIA CONDIZIONATA E REFRIGERAZIONE

MANICOTTO RIDOTTO F/F



codice	sigla	Ø	UM	min. ord. conf.	cat.	prezzo (€)
6753001	MPA5240 0030201	3/8"x1/4"	NR	2	10	25,90
6753002	MPA5240 0040201	1/2"x1/4"	NR	2	10	27,33
6753003	MPA5240 0040301	1/2"x3/8"	NR	2	10	33,60
6753020	MPA5240 0050201	5/8"x1/4"	NR	2	10	34,19
6753004	MPA5240 0050301	5/8"x3/8"	NR	2	10	34,38
6753005	MPA5240 0050401	5/8"x1/2"	NR	2	10	35,95
6753006	MPA5240 0060301	3/4"x3/8"	NR	2	10	38,67
6753007	MPA5240 0060401	3/4"x1/2"	NR	2	10	34,75
6753008	MPA5240 0060501	3/4"x5/8"	NR	2	10	36,34
6753009	MPA5240 0070401	7/8"x1/2"	NR	2	10	40,63
6753010	MPA5240 0070501	7/8"x5/8"	NR	2	10	41,41
6753011	MPA5240 0070601	7/8"x3/4"	NR	2	10	43,76
6753012	MPA5240 0080601	1"x3/4"	NR	1	10	44,55
6753013	MPA5240 0090501	1"1/8x5/8"	NR	1	10	46,90
6753014	MPA5240 0090601	1"1/8x3/4"	NR	1	10	48,44
6753015	MPA5240 0090701	1"1/8x7/8"	NR	1	10	53,14
6753016	MPA5240 0090801	1"1/8x1"	NR	1	10	55,36
6753017	MPA5240 0110701	1"3/8x7/8"	NR	1	10	62,72
6753018	MPA5240 0110801	1"3/8x1"	NR	1	10	65,58
6753019	MPA5240 0110901	1"3/8x1"1/8"	NR	1	10	67,26

TEE F/F /F



codice	sigla	Ø	UM	min. ord. conf.	cat.	prezzo (€)
6764001	MPA5T 002020201	1/4"	NR	3	10	35,95
6764002	MPA5T 003030301	3/8"	NR	3	10	38,28
6764003	MPA5T 004040401	1/2"	NR	3	10	40,63
6764004	MPA5T 005050501	5/8"	NR	2	10	43,76
6764005	MPA5T 006060601	3/4"	NR	2	10	46,90
6764006	MPA5T 007070701	7/8"	NR	2	10	49,22
6764007	MPA5T 008080801	1"	NR	1	10	51,58
6764008	MPA5T 009090901	1"1/8"	NR	1	10	56,25
6764009	MPA5T 011111101	1"3/8"	NR	1	10	91,36

MANICOTTO CARTELLATO IN RAME, DADO GIREVOLE IN OTTONE



codice	sigla	Ø	UM	min. ord. conf.	cat.	prezzo (€)
6759001	MPA5285G0020201	1/4"	NR	4	10	25,37
6759002	MPA5285G0030301	3/8"	NR	4	10	33,74
6759003	MPA5285G0040401	1/2"	NR	2	10	42,03
6759004	MPA5285G0050501	5/8"	NR	2	10	49,59
6759005	MPA5285G0060601	3/4"	NR	2	10	64,79

MANICOTTO RIDOTTO M/F



codice	sigla	Ø	UM	min. ord. conf.	cat.	prezzo (€)
6755001	MPA5243 0030201	3/8"x1/4"	NR	2	10	21,08
6755002	MPA5243 0040301	1/2"x3/8"	NR	2	10	20,33
6755003	MPA5243 0050301	5/8"x3/8"	NR	2	10	19,15
6755004	MPA5243 0050401	5/8"x1/2"	NR	2	10	19,15
6755005	MPA5243 0060401	3/4"x1/2"	NR	2	10	25,79
6755006	MPA5243 0060501	3/4"x5/8"	NR	2	10	28,14
6755007	MPA5243 0070401	7/8"x1/2"	NR	2	10	21,08
6755008	MPA5243 0070501	7/8"x5/8"	NR	2	10	22,65
6755009	MPA5243 0070601	7/8"x3/4"	NR	2	10	23,44
6755010	MPA5243 0090401	1"1/8x1/2"	NR	1	10	27,36
6755011	MPA5243 0090501	1"1/8x5/8"	NR	1	10	28,92
6755012	MPA5243 0090601	1"1/8x3/4"	NR	1	10	30,46
6755013	MPA5243 0090701	1"1/8x7/8"	NR	1	10	32,82
6755014	MPA5243 0110701	1"3/8x7/8"	NR	1	10	59,36
6755015	MPA5243 0110801	1"3/8x1"	NR	1	10	60,93
6755016	MPA5243 0110901	1"3/8x1"1/8"	NR	1	10	70,87

TAPPO F



codice	sigla	Ø	UM	min. ord. conf.	cat.	prezzo (€)
6763001	MPA5301 0020001	1/4"	NR	3	10	19,54
6763002	MPA5301 0030001	3/8"	NR	3	10	20,33
6763003	MPA5301 0040001	1/2"	NR	3	10	22,65
6763004	MPA5301 0050001	5/8"	NR	2	10	27,36
6763005	MPA5301 0060001	3/4"	NR	2	10	31,25
6763006	MPA5301 0070001	7/8"	NR	2	10	35,17
6763007	MPA5301 0080001	1"	NR	1	10	39,06
6763008	MPA5301 0090001	1"1/8"	NR	1	10	42,98
6763009	MPA5301 0110001	1"3/8"	NR	1	10	48,83

MISURATORE DI PROFONDITÀ E PENNARELLO



codice	sigla	Ø	UM	min. ord. conf.	cat.	prezzo (€)
6766001	MPA DEPTH GAUGE	1/4" - 1"3/8"	NR	1	10	18,93

LUBRIFICANTE PER O-RING 100ml



codice	sigla	UM	min. ord. conf.	cat.	prezzo (€)	
6766002	MPABPSOIL100ML	NR	1	25	10	27,52

RACCORDERIA PER TUBO POLIETILENE

RACCORDERIA A COMPRESSIONE E PRESE STAFFA

PRESSIONE NOMINALE A 20°

- Raccordi a compressione: PN 16bar
- Prese a Staffa: PN 10bar

TEMPERATURA MASSIMA D'IMPIEGO

Fino a 45°C nei limiti dei campi d'impiego dei tubi di polietilene.

NORME DI RIFERIMENTO

- Conformi alle normative ISO, UNI, DIN
- Filettature UNI-ISO 7/1, DIN 2999, BS 21, EN 10226-1
- Flange UNI 2223, DIN 8063, UNI EN 1092-1, UNI 2278

PRESCRIZIONI SANITARIE

- Conformi a D.M. n° 174 del 06/04/2004

MATERIALI DEI COMPONENTI

- Raccordi a compressione:
Corpo del raccordo in polipropilene nero (PP-B) ad alto grado di stabilità con protezione anti UV.
Guarnizione in Gomma nitrilica nera (NBR). Bussola in polipropilene nero (PP-B). Anello di graffaggio in resina acetalica bianca (POM). Ghiera in polipropilene azzurro (PP).
- Prese a staffa:
Bulloni in acciaio galvanizzato. Fondo staffa in polipropilene nero (PP). Guarnizione in gomma nitrilica nera (NBR). Derivazione staffa in polipropilene nero (PP).

MANICOTTO

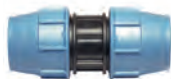

codice	sigla	Ø	UM	min. ord.	conf.	cat.	prezzo (€)
4830001	1001016000001	16	NR	70	70	02	2,11
4830002	1001020000001	20	NR	50	50	02	2,86
4830003	1001025000001	25	NR	30	30	02	3,43
4830004	1001032000001	32	NR	20	20	02	4,45
4830005	1001040000001	40	NR	10	10	02	7,21
4830006	1001051000001	50	NR	1	23	02	9,83
4830007	1001064000001	63	NR	1	15	02	13,63
4830008	1001076000001	75	NR	1	11	02	25,67
4830009	1001091000001	90	NR	1	6	02	31,76
4830010	1001111000001	110	NR	1	4	02	67,90

MANICOTTO RIDOTTO

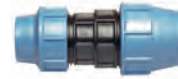

codice	sigla	Ø	UM	min. ord.	conf.	cat.	prezzo (€)
4831002	1002025020001	25x20	NR	40	40	02	3,13
4831003	1002032025001	32x25	NR	25	25	02	4,08
4831005	1002040032001	40x32	NR	15	15	02	7,04
4831007	1002051032001	50x32	NR	8	8	02	9,11
4831008	1002051040001	50x40	NR	6	6	02	9,11

RACCORDO FEMMINA

La bocca filettata è rinforzata da anello in acciaio inox dal Ø 40 in poi.



codice	sigla	Ø	UM	min. ord.	conf.	cat.	prezzo (€)
4833003	1004020002001	20x1/2"	NR	90	90	02	1,80
4833004	1004020003001	20x3/4"	NR	90	90	02	1,80
4833007	1004025003001	25x3/4"	NR	50	50	02	2,11
4833010	1004032003001	32x3/4"	NR	30	30	02	2,65
4833011	1004032004001	32x1"	NR	30	30	02	2,65
4833014	1004040005001	40x1"1/4	NR	20	20	02	4,11
4833017	1004051006001	50x1"1/2	NR	1	45	02	5,92
4833021	1004064007001	63x2"	NR	1	28	02	8,33
4833024	1004076008001	75x2"1/2	NR	1	18	02	16,63
4833028	1004091009001	90x3"	NR	1	10	02	20,43
4833031	1004111010001	110x4"	NR	1	6	02	48,31

RACCORDO MASCHIO



codice	sigla	Ø	UM	min. ord.	conf.	cat.	prezzo (€)
4832002	1003016002001	16x1/2"	NR	140	140	02	1,39
4832004	1003020002001	20x1/2"	NR	80	80	02	1,67
4832005	1003020003001	20x3/4"	NR	80	80	02	1,67
4832008	1003025003001	25x3/4"	NR	50	50	02	1,90
4832009	1003025004001	25x1"	NR	50	50	02	1,90
4832010	1003032003001	32x3/4"	NR	30	30	02	2,41
4832011	1003032004001	32x1"	NR	30	30	02	2,41
4832013	1003040004001	40x1"	NR	20	20	02	4,49
4832014	1003040005001	40x1"1/4	NR	20	20	02	4,49
4832015	1003040006001	40x1"1/2	NR	20	20	02	4,49
4832019	1003051006001	50x1"1/2	NR	1	45	02	5,88
4832020	1003051007001	50x2"	NR	1	45	02	5,88
4832023	1003064007001	63x2"	NR	1	28	02	8,33
4832026	1003076008001	75x2"1/2	NR	1	18	02	16,63
4832030	1003091009001	90x3"	NR	1	10	02	19,65
4832034	1003111010001	110x4"	NR	1	6	02	38,73

GOMITO A 90°



codice	sigla	Ø	UM	min. ord.	conf.	cat.	prezzo (€)
4835002	1006020000001	20	NR	50	50	02	2,86
4835003	1006025000001	25	NR	30	30	02	3,50
4835004	1006032000001	32	NR	20	20	02	4,35
4835005	1006040000001	40	NR	10	10	02	7,58
4835006	1006051000001	50	NR	1	22	02	10,61
4835007	1006064000001	63	NR	1	13	02	12,85
4835008	1006076000001	75	NR	1	9	02	24,92
4835009	1006091000001	90	NR	1	5	02	30,94
4835010	1006111000001	110	NR	1	4	02	64,09

RACCORDERIA PER TUBO POLIETILENE

RACCORDERIA A COMPRESSIONE E PRESE STAFFA

GOMITO A 90° CON DERIVAZIONE MASCHIO



codice	sigla	Ø	UM	min. ord.	conf.	cat.	prezzo (€)
4837003	1008020002001	20x1/2"	NR	75	75	02	1,90
4837004	1008020003001	20x3/4"	NR	75	75	02	1,90
4837005	1008025002001	25x1/2"	NR	50	50	02	2,31
4837006	1008025003001	25x3/4"	NR	50	50	02	2,31
4837010	1008032004001	32x1"	NR	30	30	02	2,99
4837013	1008040005001	40x1"1/4	NR	15	15	02	4,79
4837016	1008051006001	50x1"1/2	NR	1	36	02	6,56
4837019	1008064007001	63x2"	NR	1	20	02	9,11
4837021	1008076008001	75x2"1/2	NR	1	13	02	19,21
4837023	1008091009001	90x3"	NR	1	7	02	24,07

GOMITO A 90° CON DERIVAZIONE FEMMINA

La bocca filettata è rinforzata da anello in acciaio inox dal Ø 40x1"1/4 in poi.



codice	sigla	Ø	UM	min. ord.	conf.	cat.	prezzo (€)
4838003	1009020002001	20x1/2"	NR	60	60	02	2,14
4838004	1009020003001	20x3/4"	NR	60	60	02	2,14
4838005	1009025002001	25x1/2"	NR	35	35	02	2,72
4838006	1009025003001	25x3/4"	NR	35	35	02	2,72
4838009	1009032003001	32x3/4"	NR	25	25	02	3,16
4838010	1009032004001	32x1"	NR	25	25	02	3,16
4838013	1009040004001	40x1"	NR	15	15	02	6,26
4838014	1009040005001	40x1"1/4	NR	15	15	02	6,26
4838017	1009051006001	50x1"1/2	NR	1	29	02	8,33
4838020	1009064007001	63x2"	NR	1	17	02	11,36
4838023	1009076008001	75x2"1/2	NR	1	10	02	19,65
4838025	1009091009001	90x3"	NR	1	6	02	37,57

TEE A 90°



codice	sigla	Ø	UM	min. ord.	conf.	cat.	prezzo (€)
4834001	1005016000001	16	NR	40	40	02	2,79
4834002	1005020000001	20	NR	30	30	02	3,77
4834003	1005025000001	25	NR	15	15	02	4,96
4834004	1005032000001	32	NR	10	10	02	6,43
4834005	1005040000001	40	NR	6	6	02	10,61
4834006	1005051000001	50	NR	1	13	02	14,35
4834007	1005064000001	63	NR	1	7	02	20,43
4834008	1005076000001	75	NR	1	4	02	35,46
4834009	1005091000001	90	NR	1	2	02	49,06

GOMITO A 90° CON DERIVAZIONE LATERALE FEMMINA



codice	sigla	Ø	UM	min. ord.	conf.	cat.	prezzo (€)
4845001	1023025002001	25x1/2"	NR	25	25	02	5,00
4845003	1023032003001	32x3/4"	NR	20	20	02	6,22

TEE A 90° CON DERIVAZIONE FEMMINA

La bocca filettata è rinforzata da anello in acciaio inox dal Ø 40 in poi.



codice	sigla	Ø	UM	min. ord.	conf.	cat.	prezzo (€)
4836003	1007020002001	20x1/2"x20	NR	40	40	02	2,99
4836006	1007025003001	25x3/4"x25	NR	25	25	02	3,81
4836009	1007032003001	32x3/4"x32	NR	15	15	02	4,96
4836010	1007032004001	32x1"x32	NR	15	15	02	4,96
4836013	1007040005001	40x1"1/4x40	NR	8	8	02	9,11
4836016	1007051006001	50x1"1/2x50	NR	1	18	02	12,10
4836020	1007064007001	63x2"x63	NR	1	12	02	17,37
4836023	1007076008001	75x2"1/2x75	NR	1	7	02	28,66
4836026	1007091009001	90x3"x90	NR	1	4	02	44,51

TAPPO FINE LINEA



codice	sigla	Ø	UM	min. ord.	conf.	cat.	prezzo (€)
4841001	1012016000001	16	NR	140	140	02	1,53
4841002	1012020000001	20	NR	100	100	02	1,94
4841003	1012025000001	25	NR	50	50	02	2,14
4841004	1012032000001	32	NR	40	40	02	2,65
4841005	1012040000001	40	NR	20	20	02	4,45
4841006	1012051000001	50	NR	10	10	02	6,56
4841007	1012064000001	63	NR	1	30	02	8,91
4841008	1012076000001	75	NR	1	22	02	21,15
4841009	1012091000001	90	NR	1	12	02	24,14

RACCORDERIA PER TUBO POLIETILENE

RACCORDERIA A COMPRESSIONE E PRESE STAFFA

PRESA A STAFFA



codice	sigla	Ø	UM	min. ord.	conf.	cat.	prezzo (€)
4880001	1019025002001	25x1/2"	NR	1	180	07	1,26
4880003	1019032002001	32x1/2"	NR	1	140	07	1,65
4880004	1019032003001	32x3/4"	NR	1	140	07	1,65
4880006	1019040002001	40x1/2"	NR	1	110	07	1,96
4880007	1019040003001	40x3/4"	NR	1	110	07	1,96
4880008	1019040004001	40x1"	NR	1	110	07	1,96
4880009	1019050002001	50x1/2"	NR	1	80	07	2,21
4880010	1019050003001	50x3/4"	NR	1	80	07	2,21
4880013	1019063002001	63x1/2"	NR	1	55	07	3,01
4880014	1019063003001	63x3/4"	NR	1	55	07	3,01
4880023	1019075007001	75x2"	NR	1	40	07	4,17

PRESA A STAFFA CON ANELLO DI RINFORZO



codice	sigla	Ø	UM	min. ord.	conf.	cat.	prezzo (€)
4882001	1026025002001	25x1/2"	NR	1	180	07	2,28
4882002	1026025003001	25x3/4"	NR	1	180	07	2,28
4882003	1026032002001	32x1/2"	NR	1	140	07	3,05
4882004	1026032003001	32x3/4"	NR	1	140	07	3,05
4882006	1026040002001	40x1/2"	NR	1	110	07	3,40
4882007	1026040003001	40x3/4"	NR	1	110	07	3,40
4882008	1026040004001	40x1"	NR	1	110	07	3,40
4882009	1026050002001	50x1/2"	NR	1	80	07	3,71
4882010	1026050003001	50x3/4"	NR	1	80	07	3,71
4882011	1026050004001	50x1"	NR	1	80	07	3,71
4882012	1026050005001	50x1/4"	NR	1	80	07	3,71
4882014	1026063003001	63x3/4"	NR	1	55	07	4,83
4882015	1026063004001	63x1"	NR	1	55	07	4,83
4882016	1026063005001	63x1"1/4	NR	1	55	07	4,83
4882017	1026063006001	63x1"1/2	NR	1	55	07	4,83
4882022	1026075006001	75x1"1/2	NR	1	40	07	6,69
4882029	1026090007001	90x2"	NR	1	30	07	7,67
4882035	1026110007001	110x2"	NR	1	19	07	8,61

PRESA STAFFA LABLU CON ANELLI DI RINFORZO PN16



codice	sigla	Ø	UM	min. ord.	conf.	cat.	prezzo (€)
4884052	1031026002001	25x1/2"	NR	40	40	07	4,41
4884053	1031026003001	25x3/4"	NR	40	40	07	4,41

RACCORDERIA PER TUBO POLIETILENE

GIUNTI DI TRANSIZIONE

GIUNTI TRANSIZIONE CURVI RIVESTITI FILETTATI GAS/ACQUA

Giunti di transizione acciaio-PE - PE 100/SDR 11 - S5 GAS - PN 16 20°C
CONFORME NORMATIVA UNI CEI EN ISO/IEC 1750 - NORMA UNI 9736



codice	sigla	Ø	UM	min. ord.	conf.	cat.	prezzo (€)
4801001	3696025003001	25x3/4"	NR	1	14	02	57,09
4801002	3696032004001	32x1"	NR	1	12	02	65,01
4801003	3696040005001	40x1"1/4	NR	1	10	02	75,31
4801004	3696050006001	50x1"1/2	NR	1	8	02	86,22
4801005	3696063007001	63x2"	NR	1	5	02	105,03

GIUNTI TRANSIZIONE RETTILINEI RIVESTITI FILETTATI GAS/ACQUA

Giunti di transizione acciaio-PE - PE 100/SDR 11 - S5 GAS - PN 16 20°C
CONFORME NORMATIVA UNI CEI EN ISO/IEC 1750 - NORMA UNI 9736



codice	sigla	Ø	UM	min. ord.	conf.	cat.	prezzo (€)
4802001	3666025003001	25x3/4"	NR	1	30	02	27,95
4802002	3666032004001	32x1"	NR	1	30	02	29,17
4802003	3666040005001	40x1"1/4	NR	1	20	02	34,65
4802004	3666050006001	50x1"1/2	NR	1	15	02	39,51
4802005	3666063007001	63x2"	NR	1	10	02	46,78
4802006	3666075008001	75x2"1/2	NR	1	8	02	57,05
4802007	3666090009001	90x3"	NR	1	6	02	95,34
4802008	3666110010001	110x4"	NR	1	4	02	199,38

GIUNTI TRANSIZIONE RETTILINEI IN RAME GAS/ACQUA

Giunti di transizione rame-PE
PE 100/SDR 11 - S5 GAS - PN 16 20°C



codice	sigla	Ø	UM	min. ord.	conf.	cat.	prezzo (€)
4805001	3676032022001	32x22	NR	1	60	02	40,66

GIUNTI DIELETTRICI FILETTATI MF

Giunto isolante (dielettrico) PN10 idoneo per utenze gas e acqua.
Temperatura massima 70°C.
CONFORME ALLA NORMATIVA UNI CIG 10284.



	codice	Ø	UM	min. ord.	conf.	cat.	prezzo (€)
●	4501001	1/2"	NR	1	10	03	28,56
●	4501002	3/4"	NR	1	10	03	29,91
●	4501003	1"	NR	1	5	03	35,28
●	4501004	1"1/4	NR	1	5	03	47,70
●	4501005	1"1/2	NR	1	5	03	55,11
●	4501006	2"	NR	1	3	03	78,96
●	4501007	2"1/2	NR	1	2	03	170,01
●	4501008	3"	NR	1	2	03	241,92
●	4501009	4"	NR	1	2	03	420,00

GIUNTI TRANSIZIONE OTTONE FILETTATI MASCHIO A SALDARE

Giunti di transizione ottone-PE - PE 100/SDR 11 - S5 GAS - PN 16 20°C
CONFORME NORMATIVA UNI CEI EN ISO/IEC 1750 - NORMA UNI 9736



codice	sigla	Ø	UM	min. ord.	conf.	cat.	prezzo (€)
4808001	3626025003001	25x3/4"	NR	1	45	02	20,16
4808002	3626032004001	32x1"	NR	1	30	02	22,24
4808003	3626040005001	40x1"1/4	NR	1	15	02	28,80
4808004	3626050006001	50x1"1/2	NR	1	10	02	33,86
4808005	3626063007001	63x2"	NR	1	6	02	44,37
4808006	3626075008001	75x2"1/2	NR	1	6	02	69,60
4808007	3626090009001	90x3"	NR	1	4	02	100,54

GIUNTI TRANSIZIONE OTTONE FILETTATI FEMMINA A SALDARE

Giunti di transizione ottone-PE - PE 100/SDR 11 - S5 GAS - PN 16 20°C
CONFORME NORMATIVA UNI CEI EN ISO/IEC 1750 - NORMA UNI 9736



codice	sigla	Ø	UM	min. ord.	conf.	cat.	prezzo (€)
4809001	3636025003001	25x3/4"	NR	1	45	02	21,01
4809003	3636032004001	32x1"	NR	1	30	02	23,15
4809005	3636040005001	40x1"1/4	NR	1	15	02	29,99
4809007	3636050006001	50x1"1/2	NR	1	10	02	35,26
4809009	3636063007001	63x2"	NR	1	6	02	46,21
4809010	3636075008001	75x2"1/2	NR	1	6	02	83,47
4809011	3636090009001	90x3"	NR	1	6	02	104,72

RACCORDERIA PER TUBO POLIETILENE

RACCORDI ELETTROSALDABILI E TESTA/TESTA

INFORMAZIONI TECNICHE GENERALI

LIMITI DI IMPIEGO

I raccordi elettrosaldabili realizzati in PE100 sono accoppiabili con tubi PE80 e PE100 aventi SDR 26 (tranne i diametri fino al 125 mm), SDR17, e SDR136 (tranne i diametri fino al 32 mm), SDR 11 e SDR 7,4 (per tutti i diametri). Sono omologati per pressioni nominali di 16 bar per acqua e S5 per gas salvo diverse specifiche indicate per ciascun articolo. La pressione di esercizio della giunzione (sistema tubo + raccordo) è la minima fra la pressione nominale del tubo e la pressione nominale del raccordo.

CARATTERISTICHE

Collegamenti elettrici a mezzo di morsetti Ø 4.0 mm con tensione di saldatura 40,0 V. Su ogni articolo è riportato: codice a barre per la lettura con penna ottica, diametro nominale, tempo di fusione e tempo di raffreddamento.

PRESCRIZIONI SANITARIE

I raccordi elettrosaldabili sono prodotti con materiali idonei al convogliamento di acqua potabile e fluidi alimentari secondo le leggi e prescrizioni vigenti in Italia ed in numerosi altri Paesi. Sono inoltre conformi alle norme igienico-sanitarie del Decreto Ministeriale n°174 del 06/04/2004.

MATERIALE

Polietilene alta densità (HDPE).

MARCHIO DI CONFORMITA'

IIP (Istituto Italiano Plastici) secondo le normative UNI EN 12201, UNI EN 1555, EN 12201, EN1555.

MANICOTTO

PE 100 - S5 GAS - PN 16 20°C



codice	sigla	Ø	UM	min. ord.	conf.	cat.	prezzo (€)
4820002	3001026000001	25	NR	1	45	02	6,77
4820003	3001033000001	32	NR	1	30	02	6,90
4820004	3001041000001	40	NR	1	20	02	7,58
4820005	3001051000001	50	NR	1	16	02	10,37
4820006	3001064000001	63	NR	1	12	02	10,95
4820007	3001076000001	75	NR	1	12	02	17,17
4820008	3001091000001	90	NR	1	32	02	18,43
4820009	3001111000001	110	NR	1	18	02	22,54
4820010	3001125000001	125	NR	1	12	02	40,09
4820011	3001140000001	140	NR	1	10	02	49,67
4820012	3001160000001	160	NR	1	8	02	53,01

MANICOTTO DI RIDUZIONE

PE 100 - S5 GAS - PN 16 20°C



codice	sigla	Ø	UM	min. ord.	conf.	cat.	prezzo (€)
4820103	3002033026001	32x25	NR	1	35	02	12,14
4820104	3002041033001	40x32	NR	1	27	02	24,14
4820105	3002051033001	50x32	NR	1	16	02	25,84
4820106	3002064033001	63x32	NR	1	12	02	27,00
4820107	3002064041001	63x40	NR	1	12	02	27,00
4820108	3002064051001	63x50	NR	1	12	02	27,00
4820120	3002076064001	75x63	NR	1	1	02	33,05
4820109	3002091064001	90x63	NR	1	8	02	41,41
4820110	3002091076001	90x75	NR	1	1	02	44,20
4820111	3002111091001	110x90	NR	1	1	02	58,65
4820113	3002125090001	125x90	NR	1	1	02	83,74
4820122	3002125110001	125x110	NR	1	1	02	104,24

GOMITO A 90°

PE 100 - S5 GAS - PN 16 20°C



codice	sigla	Ø	UM	min. ord.	conf.	cat.	prezzo (€)
4821101	3004026000001	25	NR	1	25	02	15,57
4821102	3004033000001	32	NR	1	20	02	15,57
4821103	3004041000001	40	NR	1	12	02	18,87
4821104	3004051000001	50	NR	1	10	02	25,94
4821105	3004064000001	63	NR	1	10	02	29,14
4821106	3004076000001	75	NR	1	8	02	45,29
4821107	3004091000001	90	NR	1	16	02	45,39
4821108	3004111000001	110	NR	1	10	02	65,42
4821109	3004125000001	125	NR	1	6	02	115,40
4821112	3004140000001	140	NR	1	1	02	155,01

GOMITO A 45°

PE 100 - S5 GAS - PN 16 20°C



codice	sigla	Ø	UM	min. ord.	conf.	cat.	prezzo (€)
4821201	3005033000001	32	NR	1	20	02	20,94
4821202	3005041000001	40	NR	1	16	02	21,86
4821203	3005051000001	50	NR	1	12	02	30,74
4821204	3005064000001	63	NR	1	12	02	32,74
4821205	3005076000001	75	NR	1	10	02	49,71
4821206	3005091000001	90	NR	1	18	02	57,26
4821207	3005111000001	110	NR	1	12	02	76,60
4821208	3005125000001	125	NR	1	1	02	118,86
4821211	3005140000001	140	NR	1	1	02	155,01

RACCORDERIA PER TUBO POLIETILENE

RACCORDI ELETTROSALDABILI E TESTA/TESTA

TEE INTERMEDIO

PE 100 - S5 GAS - PN 16 20°C



codice	sigla	Ø	UM	min. ord.	conf.	cat.	prezzo (€)
4821002	3003026000001	25	NR	1	20	02	17,48
4821003	3003033000001	32	NR	1	12	02	19,45
4821004	3003041000001	40	NR	1	8	02	27,88
4821005	3003051000001	50	NR	1	12	02	30,02
4821006	3003064000001	63	NR	1	8	02	30,77
4821007	3003076000001	75	NR	1	16	02	49,88
4821008	3003091000001	90	NR	1	10	02	56,78
4821009	3003111000001	110	NR	1	6	02	78,68
4821010	3003125000001	125	NR	1	1	02	119,07
4821013	3003140000001	140	NR	1	1	02	165,82

RIDUZIONE TESTA/TESTA

SDR 11 - S5 - PN 16



codice	sigla	Ø	UM	min. ord.	conf.	cat.	prezzo (€)
4826009	3140050040001	50x40	NR	1	54	02	6,70
4826016	3140075063001	75x63	NR	1	20	02	10,37
4826020	3140110063001	110x63	NR	1	9	02	19,24
4826021	3140110075001	110x75	NR	1	9	02	19,24
4826023	3140125110001	125x110	NR	1	19	02	26,01
4826026	3140140110001	140x110	NR	1	18	02	44,44

CARTELLA

SDR 11 - S5 - PN 16



codice	sigla	Ø	UM	min. ord.	conf.	cat.	prezzo (€)
4826504	3145063000001	63	NR	1	18	02	9,15
4826505	3145075000001	75	NR	1	11	02	11,32
4826506	3145090000001	90	NR	1	30	02	14,01
4826507	3145110000001	110	NR	1	18	02	16,86
4826508	3145125000001	125	NR	1	16	02	21,15
4826509	3145140000001	140	NR	1	12	02	27,27

FLANGIA IN ACCIAIO ZINCATO

SDR 11 - S5 - PN 16



codice	sigla	Ø	DN	UM	min. ord.	conf.	cat.	prezzo (€)
4825104	3806063000001	63	50	NR	1	1	02	23,73
4825105	3806075000001	75	65	NR	1	1	02	29,17
4825106	3806090000001	90	80	NR	1	1	02	36,58
4825107	3806110000001	110	100	NR	1	1	02	38,56
4825108	3806125000001	125	100	NR	1	1	02	39,54
4825109	3806140000001	140	125	NR	1	1	02	48,45

GIUNTI ESTENSIBILI ED ANTIVIBRANTI GAS E ACQUA

TUBI FLESSIBILI GIUNTI ANTIVIBRANTI

TUBO GAS ECOGAS USO DOMESTICO A NORMA UNI EN 14800

Tubo: acciaio inossidabile AISI 316L. Raccordi: acciaio inossidabile AISI 303 filettatura normativa EN 14800. Canotto portagirello: acciaio inossidabile AISI 303 sede di tenuta normativa EN 14800. Dado: acciaio inossidabile AISI 303 filettatura normativa EN 14800. Pressione massima: 0,5 bar. Temperatura massima: 100°C



codice	Ø	mm	tipo	UM	min. ord. conf.	cat.	prezzo (€)
● 4701211	1/2"	500	MF / FG	NR	1	21	19,49
● 4701212	1/2"	500	FG / FG	NR	1	21	19,49
● 4701215	1/2"	1000	MF / FG	NR	1	21	24,05
● 4701216	1/2"	1000	FG / FG	NR	1	21	24,05
● 4701219	1/2"	1500	MF / FG	NR	1	21	28,50
● 4701220	1/2"	1500	FG / FG	NR	1	21	28,50
● 4701221	1/2"	2000	MF / FG	NR	1	21	33,63
● 4701222	1/2"	2000	FG / FG	NR	1	21	33,63

TUBO GAS USO DOMESTICO A NORMA UNI EN 14800

Tubo: acciaio inossidabile AISI 316L. Raccordo maschio: acciaio inossidabile AISI 303 filettatura normativa EN 14800. Canotto portagirello: acciaio inox AISI 303 sede di tenuta normativa EN 14800. **Dado: acciaio inox AISI 303** filettatura normativa EN 14800.



codice	sigla	Ø	mm	tipo	UM	min. ord. conf.	cat.	prezzo (€)
4701101	E0781500	1/2"	500	MF/FG	NR	12	07	31,71
4701102	E0781510	1/2"	500	FG/FG	NR	12	07	31,71
4701103	E0781501	1/2"	750	MF/FG	NR	12	07	35,46
4701104	E0781511	1/2"	750	FG/FG	NR	12	07	35,46
4701105	E0781502	1/2"	1000	MF/FG	NR	12	07	39,06
4701106	E0781512	1/2"	1000	FG/FG	NR	12	07	39,06
4701109	E0781504	1/2"	1500	MF/FG	NR	12	07	46,83
4701110	E0781514	1/2"	1500	FG/FG	NR	12	07	46,83
4701111	E0781505	1/2"	2000	MF/FG	NR	12	07	51,10
4701112	E0781515	1/2"	2000	FG/FG	NR	12	07	51,10

FLESS. ESTENSIBILE PER GAS A NORMA UNI 11353:2010

Giunto estensibile inox AISI 316L spessore > 0,21 mm, guaina esterna in materiale termoretraibile. Raccordo, canotto, portagirello e dado in acciaio inox AISI 303; guarnizione in gomma EN 549: Raccordo maschio UNI EN 10226-1, dado ISO 228/1.

GIRELLO INOX



codice	sigla	MF/FG	mm	UM	min. ord. conf.	cat.	prezzo (€)
4702001	0801503	1/2"	90/130	NR	12	01	12,77
4702003	0801504	1/2"	120/210	NR	12	01	14,52
4702005	0801505	1/2"	180/300	NR	12	01	15,91
4702007	0801506	1/2"	240/410	NR	12	01	17,26
4702009	0801507	1/2"	290/470	NR	12	01	18,98
4702031	0809903	1/2"x3/4"	90/130	NR	12	01	15,91
4702032	0809904	1/2"x3/4"	120/210	NR	12	01	18,32
4702034	0809906	1/2"x3/4"	240/410	NR	12	01	23,83
4702011	0802003	3/4"	90/130	NR	12	01	15,91
4702013	0802004	3/4"	120/210	NR	12	01	18,32
4702015	0802005	3/4"	180/300	NR	12	01	21,05
4702017	0802006	3/4"	240/410	NR	12	01	23,83
4702019	0802007	3/4"	290/520	NR	12	01	28,31
4702023	0802504	1"	120/210	NR	12	01	23,46
4702027	0802506	1"	240/410	NR	12	01	32,11

LEGENDA:
MF = Maschio fisso
FG = Femmina girevole

KIT TUBO GAS

Kit pronto all'installazione di piani cottura, caldaie e bruciatori gas, scaldabagni. Composto da tubo corrugato pieghevole in acciaio inox AISI 316L per gas con rivestimento protettivo giallo in LDPE, già cartellato e raccordato, completo di collari di fissaggio. Conforme alla normativa Europea UNI 15266:2007, alla normativa italiana di installazione UNI 7129:2015 e alla normativa italiana per impianti extracivili superiori a 35kw UNI 11528:2014.



codice	sigla	Ø	lunghezza (mt)	UM	min. ord. conf.	cat.	prezzo (€)
4701140	2581225R	DN12 - 1/2"	2,5	NR	1	01	84,45
4701139	2581230R	DN12 - 1/2"	3	NR	1	01	93,85
4701138	2581235R	DN12 - 1/2"	3,5	NR	1	01	103,22
4701137	2581240R	DN12 - 1/2"	4	NR	1	01	112,63

FLESS. ESTENSIBILE PER GAS A NORMA UNI 11353:2010

Giunto estensibile inox AISI 316L spessore > 0,21 mm. guaina esterna in materiale termoretraibile. Raccordo, canotto e dado in acciaio inox AISI 303, portagirello in ottone, guarnizione in gomma EN549. Raccordo maschio UNI EN 10226-1, dado ISO 228/1.

GIRELLO OTTONE



codice	sigla	MF/FG	mm	UM	min. ord. conf.	cat.	prezzo (€)
4703001	0811504	1/2"	120/210	NR	12	01	13,33
4703002	0811506	1/2"	240/410	NR	12	01	15,84
4703007	0819904	1/2x3/4"	120/210	NR	12	01	16,70
4703008	0819906	1/2x3/4"	240/410	NR	12	01	22,14
4703003	0812004	3/4"	120/210	NR	12	01	16,80
4703004	0812006	3/4"	240/410	NR	12	01	22,01
4703006	0812506	1"	240/410	NR	12	01	30,10

GIUNTI ESTENSIBILI ED ANTIVIBRANTI GAS E ACQUA

TUBI FLESSIBILI GIUNTI ANTIVIBRANTI

FLESS. ESTENSIBILE CALDAIA SENZA RIVESTIMENTO

Giunto estensibile in acciaio inox AISI 304 spessore > 0,21mm. Raccordo maschio, canotto portagirello in acciaio inox AISI 303. Dado in ottone nichelato. Raccordo maschio UNI EN 10226-1, dado ISO 228/1.



DADO OTTONE
ACQUA

codice	sigla	MF/FG	mm	UM	min. ord. conf.	cat.	prezzo (€)
4601003	0501004	3/8"	110/210	NR	12	01	10,76
4601009	0501503	1/2"	75/130	NR	12	01	8,84
4601011	0501504	1/2"	110/210	NR	12	01	10,20
4601013	0501506	1/2"	200/410	NR	12	01	12,74
4601015	0501507	1/2"	260/520	NR	12	01	14,36
4601054	0509904	1/2"x3/4"	110/210	NR	12	01	13,83
4601055	0509906	1/2"x3/4"	200/410	NR	12	01	18,88
4601017	0502003	3/4"	75/130	NR	12	01	12,01
4601019	0502004	3/4"	110/210	NR	12	01	13,83
4601021	0502006	3/4"	200/410	NR	12	01	18,88
4601023	0502007	3/4"	260/520	NR	12	01	21,09
4601025	0502503	1"	75/130	NR	12	01	16,14
4601027	0502504	1"	110/210	NR	12	01	18,15
4601029	0502506	1"	200/410	NR	12	01	24,65
4601031	0502507	1"	260/520	NR	12	01	29,01
4601035	0503204	1"1/4	110/210	NR	12	01	51,12
4601037	0503206	1"1/4	200/410	NR	12	01	58,71
4601039	0503207	1"1/4	260/520	NR	12	01	63,26
4601041	0504004	1"1/2	110/210	NR	12	01	60,85
4601043	0504006	1"1/2	200/410	NR	12	01	69,96
4601045	0504007	1"1/2	260/520	NR	12	01	75,44
4601047	0505004	2"	110/210	NR	12	01	84,12
4601049	0505006	2"	200/410	NR	12	01	95,07
4601051	0505007	2"	260/520	NR	12	01	101,67

FLESSIBILE ESTENSIBILE CALDAIA RIVESTITO

Giunto estensibile in acciaio inox spessore > 0,21 mm, guaina esterna materiale termoretraibile in poliolefina reticolata. Raccordo, canotto, portagirello in acciaio inox AISI 303; dado in ottone nichelato. Raccordo maschio UNI EN 10226-1, dado ISO 228/1.



ACQUA

codice	sigla	MF/FG	mm	UM	min. ord. conf.	cat.	prezzo (€)
4600011	0511503	1/2"	90/130	NR	12	02	12,00
4600013	0511504	1/2"	120/210	NR	12	02	13,74
4600015	0511505	1/2"	180/300	NR	12	02	15,16
4600017	0511506	1/2"	240/410	NR	12	02	16,59
4600019	0511507	1/2"	290/520	NR	12	02	18,33
4600042	0519904	1/2"x1/4"	120/210	NR	12	02	17,44
4600044	0519906	1/2"x3/4"	240/410	NR	12	02	22,92
4600021	0512003	3/4"	90/130	NR	12	02	15,20
4600023	0512004	3/4"	120/210	NR	12	02	17,44
4600025	0512005	3/4"	180/300	NR	12	02	20,23
4600027	0512006	3/4"	240/410	NR	12	02	22,92
4600029	0512007	3/4"	290/520	NR	12	02	27,37
4600033	0512504	1"	120/210	NR	12	02	22,51
4600035	0512505	1"	180/300	NR	12	02	26,86
4600037	0512506	1"	240/410	NR	12	02	31,25
4600039	0512507	1"	290/520	NR	12	02	37,20

FLESS. ESTENSIBILE CALDAIA SENZA RIVESTIMENTO

Giunto estensibile in acciaio inox AISI 304 L. spessore > 0,21. Raccordo maschio, canotto, portagirello e dado in acciaio inox AISI 303. Raccordo maschio UNI EN 10226-1, dado ISO 228/1.

DADO ANTITORSIONE



DADO INOX
ACQUA

codice	sigla	MF/FG	mm	UM	min. ord. conf.	cat.	prezzo (€)
4602001	0591503	1/2"	75/130	NR	12	01	10,92
4602003	0591504	1/2"	110/210	NR	12	01	12,31
4602005	0591506	1/2"	200/410	NR	12	01	14,03
4602007	0591507	1/2"	260/520	NR	12	01	16,57
4602025	0611500	1/2"	500/1000	NR	12	01	22,31
4602043	0599903	1/2"x3/4"	75/130	NR	12	01	14,78
4602044	0599904	1/2"x3/4"	110/210	NR	12	01	16,34
4602045	0599906	1/2"x3/4"	200/410	NR	12	01	20,66
4602009	0592003	3/4"	75/130	NR	12	01	14,26
4602011	0592004	3/4"	110/210	NR	12	01	16,34
4602013	0592006	3/4"	200/410	NR	12	01	20,66
4602015	0592007	3/4"	260/520	NR	12	01	23,13
4602031	0612000	3/4"	500/1000	NR	12	01	27,89
4602017	0592503	1"	75/130	NR	12	01	19,67
4602019	0592504	1"	110/210	NR	12	01	21,55
4602021	0592506	1"	200/410	NR	12	01	28,15
4602023	0592507	1"	260/520	NR	12	01	32,41

FLESS. ESTENSIBILE CALDAIA SENZA RIVESTIMENTO

Giunto estensibile in acciaio inox AISI 304 spessore > 0,21mm. Canotto portagirello in acciaio inox AISI 303. Dadi in ottone nichelato ISO 228/1.



DADO OTTONE
ACQUA

codice	sigla	FG/FG	mm	UM	min. ord. conf.	cat.	prezzo (€)
4601014	0501516	1/2"	200/410	NR	12	01	12,74
4601016	0501517	1/2"	260/520	NR	12	01	14,36
4601020	0502014	3/4"	110/210	NR	12	01	13,83
4601022	0502016	3/4"	200/410	NR	12	01	18,88

GIUNTI ANTIVIBRANTI FILETTATI

Giunto inox antivibrante AISI 316L. Per bruciatori, autoclavi, caldaie ecc... Maschio 1/2" e 3/4" in acciaio inox AISI 303. Maschio > 3/4 in acciaio al carbonio. Filettatura UNI EN 10226-1. Flange (DN>2) in acciaio ASTM A105 Gr B con foratura PN10.



GAS

codice	sigla	Ø	DN	mm	UM	min. ord. conf.	cat.	prezzo (€)
4730002	0542032	3/4"	20	150	NR	1	02	21,11
4730003	0542533	1"	25	165	NR	1	02	27,44
4730004	0543234	1"1/4	32	180	NR	1	02	38,69
4730005	0544035	1"1/2	40	210	NR	1	02	48,38
4730006	0545036	2"	50	230	NR	1	02	69,46

LEGENDA:
MF = Maschio fisso
FF = Femmina fissa
FG = Femmina Girevole

GIUNTI ESTENSIBILI ED ANTIVIBRANTI GAS E ACQUA

TUBI FLESSIBILI GIUNTI ANTIVIBRANTI

KIT PER CALDAIA A NORMA UNI 11353:2010

COMPOSTO DA: nr.1 flessibile estensibile gas 3/4" (MF)
nr.1 guarnizione in gomma NBR
nr.2 flessibili estensibili acqua 3/4" (MF)
nr.2 flessibili estensibili acqua 1/2" (MF)



codice	sigla	mm	UM	min. ord. conf.	cat.	prezzo (€)
4711001	0800000	180 - 300	NR	1	03	66,63
4711002	0800001	240 - 410	NR	1	03	78,45

KIT PER CALDAIA A NORMA UNI 11353:2010

COMPOSTO DA:
nr.1 guarnizione gas in gomma, nr.2 guarnizioni acqua 3/4" e nr.2 guarnizioni acqua 1/2"
nr.2 flessibili estensibili acqua 3/4" (MF)
nr.2 flessibili estensibili acqua 1/2" (MF)
nr.1 flessibile estensibile gas (MF)



codice	mm	flex gas Ø	UM	min. ord.	conf.	cat.	prezzo (€)
● 4711012	200 - 400	3/4"	NR	1	20	03	46,62

FLESS. NON ESTEN. PER CONTATORI NON RIVESTITO

Giunto non estensibile in acciaio inox AISI 316L spessore > 0,21 mm. Raccordo, canotto, portagirello in acciaio inox AISI 303. Dado in ottone. Raccordo maschio e femmina fissa UNI EN 10226-1, dado ISO 228/1.



codice	sigla	Ø	mm	UM	min. ord. conf.	cat.	prezzo (€)
4740001	0562140	3/4" FFx1" FG	160	NR	1	02	25,60
4740002	0562100	3/4" MFx1" FG	160	NR	1	02	24,38
4740003	0562142	3/4" FFx1" FG	200	NR	1	02	26,69
4740009	0563143	3/4" FFx1" 1/4 FG	300	NR	1	02	37,26
4740016	0563303	1" MFx1" 1/4 FG	300	NR	1	02	46,95

GUARNIZIONE IN GOMMA NBR EN549 sp.2,5mm

Per flessibili gas.
Confezione 100 pz. (1/2" x 3/4")
Confezione 50 pz. (1")



codice	sigla	Ø	UM	min. ord. conf.	cat.	prezzo (€)
4744003	0650004	DN15 (1/2")	CF	1	09	27,24
4744004	0650005	DN20 (3/4")	CF	1	09	36,72
4744006	0650006	DN25 (1")	CF	1	09	28,80

KIT PER CALDAIA A NORMA UNI 11353:2010 RIVESTITO

COMPOSTO DA:
nr.1 guarnizione gas in gomma, nr.2 guarnizioni acqua 3/4" e nr.2 guarnizioni acqua 1/2"
nr.2 flessibili estensibili acqua 3/4" (MF) RIVESTITI BIANCHI
nr.2 flessibili estensibili acqua 1/2" (MF) RIVESTITI BIANCHI
nr.1 flessibile estensibile gas (MF)



codice	mm	flex gas Ø	UM	min. ord.	conf.	cat.	prezzo (€)
● 4711112	200 - 400	3/4"	NR	1	20	03	49,95
● 4711113	200 - 400	1/2"	NR	1	20	03	48,30

GUARNIZIONE IN GOMMA ACRILONITRILE

Per flessibile contatore



codice	sigla	Ø	UM	min. ord. conf.	cat.	prezzo (€)
4744002	0650040	1"	NR	1	09	0,68
4744001	0650030	1" 1/4	NR	1	09	0,72

JOLLY CASA ADATTATORE PER TUBI FLESSIBILI GAS

Passaggio interno D. 13-9, gommino in acrilonitrile omologato per metano GPL e gas manifatturato [D. 13 per metano D. 9 per GPL]



codice	sigla	Ø	UM	min. ord. conf.	cat.	prezzo (€)
4744005	0651530	DN15 (1/2")	NR	1	09	11,20

LEGENDA:
MF = Maschio fisso
FF = Femmina fissa
FG = Femmina Girevole

GIUNTI ESTENSIBILI ED ANTIVIBRANTI GAS E ACQUA

TUBO FLESSIBILE CARTELLABILE

TUBO FLESSIBILE CARTELLABILE PER GAS

Tubo corrugato pieghevole in acciaio inox AISI 316L, per gas con rivest. protettivo giallo in LDPE. Temperatura max. 100°C. Pressione max. di esercizio 0,5 bar. Conforme EN 15266:2007



codice	sigla	Ø	lungh. (mt)	UM	min. ord. conf.	cat.	prezzo (€)
4606010	2581205	DN12 - 1/2"	5	RT	1	01	74,22
4606011	2581210	DN12 - 1/2"	10	RT	1	01	148,40
4606015	2581510	DN15 - 3/4"	10	RT	1	01	176,06

TUBO FLESSIBILE CARTELLABILE AISI 304

Tubo corrugato pieghevole in acciaio inox AISI 304 per acqua. Pressione max. di esercizio: 15 bar.



codice	sigla	DN	lungh. (mt)	UM	min. ord. conf.	cat.	prezzo (€)
4606100	5581205	DN12 - 1/2"	5	RT	1	01	50,92
4606101	5581210	DN12 - 1/2"	10	RT	1	01	101,84
4606104	5581505	DN15 - 3/4"	5	RT	1	01	63,29
4606105	5581510	DN15 - 3/4"	10	RT	1	01	126,59

NIPPLE CILINDRICO

Confezione 10 pz.



codice	sigla	Ø	UM	min. ord. conf.	cat.	prezzo (€)
4606310	3581211	DN12 - 1/2"	CF	1	01	44,62
4606311	3581511	DN15 - 3/4"	CF	1	01	70,32

DADO

Confezione 10 pz.



codice	sigla	Ø	UM	min. ord. conf.	cat.	prezzo (€)
4606301	3581201	DN12 - 1/2", Gas	CF	1	01	13,43
4606302	3581501	DN15 - 3/4", Gas	CF	1	01	22,01
4606303	0581215	DN12 - 1/2", Acqua	CF	1	01	13,43
4606304	0583415	DN15 - 3/4", Acqua	CF	1	01	22,01

NIPPLE CILINDRICO / CONICO

Confezione 10 pz.



codice	sigla	Ø	UM	min. ord. conf.	cat.	prezzo (€)
4606313	3581516	DN15 - 3/4"	CF	1	01	62,54

CARTELLATRICE UNIVERSALE EMIFIX - EMIWATER

1/2" - 3/4" - 1"



codice	sigla	descrizione	UM	min. ord. conf.	cat.	prezzo (€)
4606409	0580008	universale	NR	1	01	307,69

DIMA

Compatibile con nuova cartellatrice 4606409.



codice	sigla	descrizione	UM	min. ord. conf.	cat.	prezzo (€)
4606412	0580026	1/2" e 3/4" (per cartellatrice Eurotis)	NR	1	01	48,71
4606410	0580027	1/2" e 3/4" acqua e gas	NR	1	01	48,71
4606411	0580028	1" acqua e gas	NR	1	01	48,71

VALIGETTA PER TUBO CARTELLABILE

COMPOSTO DA:

- nr.1 cartellatrice (4606409)
- nr.1 dima 1/2"-3/4" acqua e gas (4606410)
- nr.1 conf.(10pz) dadi 1/2" acqua (4606303)
- nr.1 conf.(10pz) dadi 3/4" acqua (4606304)
- nr.1 conf.(10pz) dadi 1/2" gas (4606301)
- nr.1 conf.(10pz) dadi 3/4" gas (4606302)



codice	sigla	descrizione	UM	min. ord. conf.	cat.	prezzo (€)
4606401	0580004	1/2" - 3/4"	NR	1	01	389,33

GIUNTI ESTENSIBILI ED ANTIVIBRANTI GAS E ACQUA

TUBI FLESSIBILI INOX E ALLUMINIO

TUBO ALLUMINIO BIANCO

Tubo flessibile ed estensibile fino a 3 metri



codice	sigla	Ø	UM	min. ord. conf.	cat.	prezzo (€)
4655003	0001080	80	MT	3	22	11,59
4655004	0001090	90	MT	3	22	13,02
4655005	0001100	100	MT	3	22	13,78
4655006	0001110	110	MT	3	22	15,16
4655007	0001120	120	MT	3	22	16,46
4655009	0001130	130	MT	3	22	17,81
4655010	0001140	140	MT	3	22	19,19
4655011	0001150	150	MT	3	22	20,54
4655012	0001160	160	MT	3	22	21,84
4655014	0001180	180	MT	3	22	24,78
4655015	0001200	200	MT	3	22	27,38

FASCETTA STRINGITUBO E-FLEX



codice	sigla	Ø	UM	min. ord. conf.	cat.	prezzo (€)
4662003	0075170	60/170	NR	1	02	4,08
4662004	0075215	60/215	NR	1	02	4,83
4662006	0075525	60/525	NR	1	02	11,36

TUBO ALLUMINIO NATURALE

Tubo flessibile ed estensibile fino a 3 metri



codice	sigla	Ø	UM	min. ord. conf.	cat.	prezzo (€)
4654002	0000075	75	MT	3	22	9,53
4654003	0000080	80	MT	3	22	9,70
4654004	0000090	90	MT	3	22	9,95
4654005	0000100	100	MT	3	22	10,29
4654006	0000110	110	MT	3	22	11,42
4654007	0000120	120	MT	3	22	12,43
4654008	0000125	125	MT	3	22	12,85
4654009	0000130	130	MT	3	22	13,86
4654021	0000135	135	MT	3	22	14,24
4654010	0000140	140	MT	3	22	14,70
4654022	0000145	145	MT	3	22	14,99
4654011	0000150	150	MT	3	22	15,33
4654012	0000160	160	MT	3	22	17,18
4654014	0000180	180	MT	3	22	20,33
4654015	0000200	200	MT	3	22	22,68
4654018	0000250	250	MT	3	22	31,04
4654020	0000300	300	MT	3	22	40,45

FASCETTA STRINGITUBO MIGNON



codice	sigla	Ø	UM	min. ord. conf.	cat.	prezzo (€)
4663001	0072017	10/16	NR	1	02	1,26
4663003	0072024	12/22	NR	1	02	1,33
4663005	0072031	20/32	NR	1	02	1,39
4663006	0072038	25/40	NR	1	02	1,39

TUBO SOLARE

TWIN SOLAR SLIM

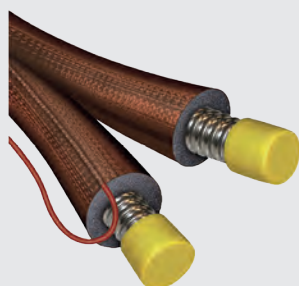

TWIN SOLAR SLIM

Per impianti solari termici. Tubo flessibile in acciaio AISI 316 L con isolamento in gomma di colore rosso coppo, ideale per l'installazione sottotegola/cavedio. Resistente ai raggi UV e alle alte temperature fino a + 150°C, alta resistenza meccanica. Compreso di cavo sensore di temperatura.

DATI TECNICI

GUAINA ISOLANTE		
PROPRIETÀ	VALORE	NORME DI RIFERIMENTO
Temperatura d'impiego	-40°C 150°C	EN 14706 - EN 14707
Conducibilità termica λ W/(m•K)	0°C = 0,040	EN 13787 - EN ISO 8497
Fuoco	Euroclasse E	EN 13501-1

CAVO SENSORE	
PROPRIETÀ	VALORE
Temperatura di esercizio	-60°C 200°C
Rame flessibile (conduttore) \varnothing 1mm	CEI 20-19/15
Tensione nominale	300/500 V
Resistenza elettrica	20.0 Ohm/km
Guaina di rivestimento	gomma siliconica

TUBO FLESSIBILE (ACCIAIO AISI 316 L)				
DIAMETRO	\varnothing ESTERNO	SPESSORE	PRESSIONE MAX D'ESERCIZIO	RAGGIO MINIMO CURVATURA
DN 16	21,3 \pm 0,2 mm	0,18 mm	16 bar	25 mm
DN 20	26,4 \pm 0,2 mm	0,18 mm	10 bar	30 mm
DN 25	31,8 \pm 0,2 mm	0,20 mm	10 bar	35 mm

TWIN SOLAR SLIM IN BOBINE

codice	sigla	sp. (mm)	DN	lung. (mt)	UM	min. ord. conf.	cat.	prezzo (€)
9169050	86TR0M090225002	9	16	50	MT	50	07	31,12
9169100	86TR0M09022A002	9	16	100	MT	100	07	31,12
9169150	86TR0M09022A502	9	16	150	MT	150	07	31,12
9209050	86TR0M090285002	9	20	50	MT	50	07	34,76
9209100	86TR0M09028A002	9	20	100	MT	100	07	34,76
9209150	86TR0M09028A502	9	20	150	MT	150	07	34,76
9259050	86TR0M090355002	9	25	50	MT	50	07	44,42
9259100	86TR0M09035A002	9	25	100	MT	100	07	44,42

TWIN SOLAR SLIM IN ROTOLI

codice	sigla	sp. (mm)	DN	lung. (mt)	UM	min. ord. conf.	cat.	prezzo (€)
9169010	86TR0M090221002	9	16	10	MT	10	07	31,12
9169015	86TR0M090221502	9	16	15	MT	15	07	31,12
9169020	86TR0M090222002	9	16	20	MT	20	07	31,12
9169025	86TR0M090222502	9	16	25	MT	25	07	31,12
9209010	86TR0M090281002	9	20	10	MT	10	07	34,76
9209015	86TR0M090281502	9	20	15	MT	15	07	34,76
9209020	86TR0M090282002	9	20	20	MT	20	07	34,76
9209025	86TR0M090282502	9	20	25	MT	25	07	34,76
9259025	86TR0M090352502	9	25	25	MT	25	07	44,42

ACCESSORI PER TWIN SOLAR SLIM

SBOBINATRICE, DEVOLGITORE



codice	descrizione	foto	UM	min. ord. conf.	cat.	prezzo (€)
850VR020444	sbobinatrice	1	NR	1	02	7.155,78
850VR020471	devolgitore	2	NR	1	02	3.213,51

INNESTO DOPPIA CONNESSIONE

Raccordo ad innesto rapido con tenuta meccanica



codice	∅ (mm)	UM	min. ord. conf.	cat.	prezzo (€)
850VR0204651	16x16	NR	8	02	25,70
850VR0204661	20x20	NR	8	02	35,16
850VR0204671	25x25	NR	8	02	40,60

INNESTO MASCHIO

Raccordo ad innesto rapido con tenuta meccanica



codice	∅ (mm)	UM	min. ord. conf.	cat.	prezzo (€)
850VR0204501	1/2"x16	NR	8	02	16,46
850VR0204511	3/4"x16	NR	8	02	19,48
850VR0204521	3/4"x20	NR	8	02	24,48
850VR0204531	1"x20	NR	8	02	26,15
850VR0204541	1"1/4x25	NR	8	02	30,43

INNESTO FEMMINA

Raccordo ad innesto rapido con tenuta meccanica



codice	∅ (mm)	UM	min. ord. conf.	cat.	prezzo (€)
850VR0204551	1/2"x16	NR	8	02	15,88
850VR0204561	3/4"x16	NR	8	02	18,80
850VR0204571	3/4"x20	NR	8	02	23,66
850VR0204581	1"x20	NR	8	02	26,11

ISOLAMENTO SOLARE IN GOMMA

SOLAR HT

Isolante elastomerico per alte temperature
La soluzione razionale per impianti solari e processi industriali fino a 150° C

DATI TECNICI

Limiti temperatura d'impiego	-40°C +150°C
Conducibilità termica λ W/(m•K) (DIN 52613) - EN 12667 (DIN 52612)	+0 °C = 0,040 +40°C = 0,044
Problematiche di corrosione	EN 13468; pH neutro
Fuoco (EN 1305-1)	Euroclasse E

SOLAR R

Rivestito in pellicola di protezione ad alta resistenza ai raggi UV
La soluzione razionale e conveniente per impiantistica solare e processi industriali
Consigliato per impianti solari e linee di vapore a bassa pressione

DATI TECNICI

Limiti temperatura d'impiego	-40°C +150°C
Fuoco (EN 1305-1)	Euroclasse E

TUBO SOLAR HT L.2mt



codice	spessore (mm)	∅ (mm)	UM	min. ord. conf.	cat.	prezzo (€)
13015215526	13	15	MT	112	21	7,11
13018215526	13	18	MT	98	21	7,75
13022215526	13	22	MT	84	21	8,25
13028215526	13	28	MT	64	21	9,12
13035215526	13	35	MT	50	21	11,70
13042215526	13	42	MT	40	21	13,00
19015215526	19	15	MT	64	21	13,00
19018215526	19	18	MT	58	21	13,57
19022215526	19	22	MT	64	21	15,39
19028215526	19	28	MT	48	21	18,43
19035215526	19	35	MT	36	21	21,28
19042215526	19	42	MT	32	21	23,98

TUBO SOLAR R IMBALLO STANDARD L.2mt



codice	spessore (mm)	∅ (mm)	UM	min. ord. conf.	cat.	prezzo (€)
14018217526KR	14	18	MT	98	02	17,34
14022217526KR	14	22	MT	84	02	19,82
20018217526KR	20	18	MT	58	02	19,82
20022217526KR	20	22	MT	50	02	22,81
20028217526KR	20	28	MT	40	02	26,38

ISOLAMENTO IN GOMMA

TUBO ST

TUBO ST L.2mt

DATI TECNICI

Proprietà	Valore	Norme di riferimento
Limiti d'impiego	-165°C +110°C	EN 14706 - EN14707
Conducibilità termica λ W/(m•K)	Spessori \leq 25mm -20 °C = 0,031 0 °C = 0,033 +20 °C = 0,035 +40 °C = 0,037	Spessori \geq 25mm -20 °C = 0,034 0 °C = 0,036 +20 °C = 0,038 +40 °C = 0,040
Problematiche di corrosione	pH neutro (7 \pm 0,5)	EN 13468
Permeabilità μ	\geq 10000	\geq 7000 EN 12086
Fuoco	EUROCLASSE B1-s2,d0	EN 13501-1



codice	sigla	spessore (mm)	\emptyset (mm)	UM	min. ord. conf.	cat.	prezzo (€)
9060120	06012005508	6	12	MT	316	18	1,01
9060150	06015005508	6	15	MT	266	18	1,06
9060180	06018005508	6	18	MT	220	18	1,10
9060200	06020005508	6	20	MT	180	18	1,15
9060220	06022005508	6	22	MT	180	18	1,30
9060250	06025005508	6	25	MT	152	18	1,49
9060280	06028005508	6	28	MT	130	18	1,54
9060350	06035005508	6	35	MT	100	18	2,06
9060420	06042005508	6	42	MT	90	18	2,30
9090100	09010005508	9	10	MT	266	18	1,15
9090120	09012005508	9	12	MT	234	18	1,25
9090150	09015005508	9	15	MT	192	18	1,34
9090180	09018005508	9	18	MT	166	18	1,49
9090200	09020005508	9	20	MT	136	18	1,49
9090220	09022005508	9	22	MT	136	18	1,49
9090250	09025005508	9	25	MT	108	18	2,02
9090280	09028005508	9	28	MT	98	18	2,11
9090350	09035005508	9	35	MT	76	18	2,30
9090420	09042005508	9	42	MT	60	18	2,59
9090480	09048005508	9	48	MT	50	18	2,93
9090540	09054005508	9	54	MT	46	18	3,84
9090600	09060005508	9	60	MT	46	18	4,03
9090760	09076005508	9	76	MT	40	18	5,28
9090890	09089005508	9	89	MT	36	18	6,62
9091140	09114005508	9	114	MT	22	18	10,75
9130120	13012005508	13	12	MT	162	18	1,78
9130150	13015005508	13	15	MT	136	18	2,02
9130180	13018005508	13	18	MT	118	18	2,11
9130220	13022005508	13	22	MT	98	18	2,11
9130250	13025005508	13	25	MT	80	18	2,40
9130280	13028005508	13	28	MT	78	18	2,59
9130350	13035005508	13	35	MT	58	18	3,02
9130420	13042005508	13	42	MT	48	18	3,55
9130480	13048005508	13	48	MT	40	18	4,03
9130540	13054005508	13	54	MT	34	18	4,99
9130600	13060005508	13	60	MT	32	18	5,33
9130640	13064005508	13	64	MT	30	18	6,24
9130760	13076005508	13	76	MT	26	18	6,67
9130890	13089005508	13	89	MT	24	18	8,35
9131140	13114005508	13	114	MT	16	18	13,25
9131250	13125005508	13	125	MT	12	18	19,63
9190150	19015005508	19	15	MT	78	18	3,79
9190180	19018005508	19	18	MT	72	18	4,27
9190200	19020005508	19	20	MT	66	18	4,51
9190220	19022005508	19	22	MT	64	18	4,61
9190250	19025005508	19	25	MT	50	18	5,09
9190280	19028005508	19	28	MT	48	18	5,33
9190320	19032005508	19	32	MT	36	18	6,29
9190350	19035005508	19	35	MT	36	18	6,62
9190420	19042005508	19	42	MT	32	18	8,02
9190480	19048005508	19	48	MT	24	18	8,98

TUBO ST L.2mt

codice	sigla	spessore (mm)	Ø (mm)	UM	min. ord. conf.	cat.	prezzo (€)
9190540	19054005508	19	54	MT	24	18	10,08
9190600	19060005508	19	60	MT	22	18	11,04
9190640	19064005508	19	64	MT	18	18	12,05
9190760	19076005508	19	76	MT	18	18	13,97
9190890	19089005508	19	89	MT	14	18	15,26
9191140	19114005508	19	114	MT	12	18	22,61
9191250	19125005508	19	125	MT	10	18	30,14
9250220	25022005508	25	22	MT	42	18	8,30
9250280	25028005508	25	28	MT	40	18	9,46
9250350	25035005508	25	35	MT	24	18	11,62
9250420	25042005508	25	42	MT	22	18	12,82
9250480	25048005508	25	48	MT	18	18	14,50
9250540	25054005508	25	54	MT	16	18	15,79
9250600	25060005508	25	60	MT	12	18	15,84
9250760	25076005508	25	76	MT	10	18	24,86
9250890	25089005508	25	89	MT	8	18	27,50
9251140	25114005508	25	114	MT	6	18	39,65
9320280	32028005508	32	28	MT	24	18	14,98
9320350	32035005508	32	35	MT	22	18	16,90
9320420	32042005508	32	42	MT	16	18	19,68
9320480	32048005508	32	48	MT	14	18	21,74
9320540	32054005508	32	54	MT	12	18	25,06
9320600	32060005508	32	60	MT	10	18	26,98
9320640	32064005508	32	64	MT	10	18	28,56
9320760	32076005508	32	76	MT	8	18	32,69
9320890	32089005508	32	89	MT	8	18	37,68
9321140	32114005508	32	114	MT	6	18	54,00
9400420	40042005508	40	42	MT	16	18	40,85
9400480	40048005508	40	48	MT	12	18	44,93
9400540	40054005508	40	54	MT	10	18	49,06
9950600	50060005508	50	60	MT	8	18	81,65
9950760	50076005508	50	76	MT	6	18	99,17
9500890	50089005508	50	89	MT	6	18	106,70
9601140	60114005508	60	114	MT	2	18	131,86

LASTRA ST IN ROTOLI h.1mt, NON ADESIVA

DATI TECNICI

Proprietà	Valore	Norme di riferimento
Limiti d'impiego	da -165°C +85°C	EN 14706 - EN14707
Conducibilità termica λ W/(m•K)	Spessori ≤ 25mm -20 °C = 0,031 0 °C = 0,033 +20 °C = 0,035 +40 °C = 0,037 Spessori ≥ 25mm -20 °C = 0,034 0 °C = 0,036 +20 °C = 0,038 +40 °C = 0,040	EN 13787 - EN 12667
Problematiche di corrosione	pH neutro (7±0,5)	EN 13468
Permeabilità μ	≥ 10000 ≥ 7000	EN 12086
Fuoco	EUROCLASSE B _L -s3,d0	EN 13501-1



codice	sigla	spessore (mm)	rotolo	UM	min. ord. conf.	cat.	prezzo (€)
80010210107S	80010210107	10	20m ²	MQ	20	18	17,28
80013210107S	80013210107	13	14m ²	MQ	14	18	21,22
80019210107S	80019210107	19	10m ²	MQ	10	18	30,00
80025210107S	80025210107	25	8m ²	MQ	8	18	38,93
80032210107S	80032210107	32	6m ²	MQ	6	18	39,89

ISOLAMENTO IN GOMMA

ACCESSORI ISOLAMENTO IN GOMMA

COLLA K 414

Adesivo per isolamento in gomma espansa, resistente agli agenti atmosferici e all'invecchiamento.



codice	contenuto (lt)	UM	min. ord.	conf.	cat.	prezzo (€)
● 2006350	0,5	NR	1	20	19	23,28

NASTRO ADESIVO ANTICONDENSA

In elastomero



codice	spess. (mm)	altezza (mm)	lungh. (mt)	UM	min. ord. conf.	cat.	prezzo (€)
● 2006341	3	50	10	NR	24	19	6,95
● 2006340	3	50	15	NR	12	19	11,55

ISOLAMENTO IN POLIETILENE

FONOMETAL

GUAINA FONOMETAL IN ROTOLI 15 mt colore BLU

Guaina isolante in polietilene espanso a cellule chiuse dello spessore 5 mm che, avvolgendo esternamente gli scarichi, riduce il livello di rumorosità molto al di sotto dei 35 dB richiesti dalla legge.

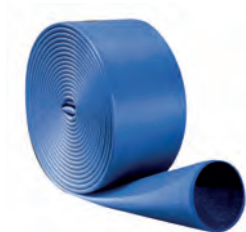

DATI TECNICI

Temperatura d'impiego	fino a -90°C
Conducibilità termica	+10°C = 0,038 W/(m x K) +40°C = 0,040 W/(m x K)
Comportamento al fuoco	Classe E _L

codice	sigla	spessore (mm)	Ø	UM	min. ord. conf.	cat.	prezzo (€)
9310002	050502185PE0CB	5	50	MT	135	09	2,84
9310004	050752185PE0CB	5	75	MT	90	09	4,16
9310006	050902185PE0CB	5	90	MT	75	09	4,96
9310007	051002185PE0CB	5	100	MT	75	09	5,16
9310008	051102185PE0CB	5	110	MT	75	09	5,24
9310009	051252185PE0CB	5	125	MT	60	09	6,40

TUBO POLAR IN BARRE L. 2mt

Tubo isolante in polietilene espanso. Indicato per impianti di condizionamento, riscaldamento e refrigerazione.

DATI TECNICI

Temperatura d'impiego	-45 °C +100 °C	
Peso Specifico	30÷35 Kg/m ³ tolleranza ±10%	
Coefficiente di conducibilità termica DIN 52613	a +40 °C = 0,035 W/ (m x K)	
Permeabilità al vapore DIN 52615 PR. EN 13469	ottima	μ 10.000
Resistenza all'ozono	ottima	
Resistenza alle muffe e agli insetti	ottima	
Tossicità	Non sprigiona fumi tossici e opachi	Certificazioni N. 003/CF/T98 N. 002/CF/T98
Comportamento al fuoco	Classe B ₁ -s1, dØ certificato CE di conformità N. 0497/CDP/4697/12	
Non contiene CFC (freon)	Legge N. 549 del 28/12/93	



codice	spessore (mm)	Ø (mm)	UM	min. ord. conf.	cat.	prezzo (€)
099060120	6	12	MT	360	20	1,19
099060160	6	15/16	MT	284	20	1,32
099060180	6	18	MT	240	20	1,36
099060200	6	20	MT	220	20	1,54
099060220	6	22	MT	194	20	1,54
099060250	6	25	MT	160	20	1,76
099060270	6	27	MT	140	20	1,85
099060280	6	28	MT	134	20	1,94
099060320	6	32	MT	120	20	2,24
099060340	6	34	MT	110	20	2,29
099060350	6	35	MT	104	20	2,51
099060420	6	42	MT	80	20	2,73
099100160	10	16	MT	180	20	1,85
099100180	10	18	MT	160	20	1,89
099100200	10	20	MT	150	20	1,89
099100220	10	22	MT	134	20	1,89
099100250	10	25	MT	120	20	2,51
099100270	10	27	MT	94	20	2,60
099100280	10	28	MT	90	20	2,77
099100320	10	32	MT	90	20	2,82
099100340	10	34	MT	84	20	2,82
099100350	10	35	MT	84	20	3,04
099100420	10	42	MT	60	20	3,26
099100480	10	48	MT	50	20	3,65
099100540	10	54	MT	40	20	4,71
099100600	10	60	MT	36	20	4,97
099100640	10	64	MT	32	20	5,37
099100760	10	76	MT	24	20	6,60
099100880	10	88	MT	20	20	8,27

codice	spessore (mm)	Ø (mm)	UM	min. ord. conf.	cat.	prezzo (€)
099150220	15	22	MT	82	20	2,64
099150280	15	28	MT	68	20	3,48
099150350	15	35	MT	60	20	3,96
099150420	15	42	MT	50	20	4,40
099150480	15	48	MT	40	20	4,97
099150540	15	54	MT	30	20	6,25
099150600	15	60	MT	24	20	6,69
099150760	15	76	MT	18	20	8,32
099150880	15	88	MT	18	20	10,43
099151140	15	114	MT	10	20	16,72
099200220	20	22	MT	60	20	5,81
099200280	20	28	MT	50	20	6,95
099200350	20	35	MT	40	20	8,76
099200420	20	42	MT	34	20	10,03
099200480	20	48	MT	30	20	11,18
099200600	20	60	MT	24	20	13,64
099200760	20	76	MT	16	20	17,38
099200880	20	88	MT	12	20	19,05
099201140	20	114	MT	8	20	28,47

ISOLAMENTO IN POLIETILENE

ISOFORM R

TUBO ISOFORM R CON PELLICOLA

Tubo isolante flessibile in polietilene espanso a cellule chiuse con pellicola antigraffio. Indicato per impianti di riscaldamento e condizionamento d'aria.

DATI TECNICI

Temperatura d'impiego	-45 °C +100 °C	
Peso Specifico	30÷35 Kg/m ³ tolleranza ±10%	
Coefficiente di conducibilità termica DIN 52613	a +40 °C = 0,040 W/ (m x K)	
Permeabilità al vapore DIN 52615 PR. EN 13469	ottima	μ 3.500
Resistenza all'ozono	ottima	
Resistenza alle muffe e agli insetti	ottima	
Tossicità	Certificazioni inerenti alla tossicità e opacità dei fumi	N. 100/CF/T/97 16/01/98 N. 101/CF/T/97 16/01/98
Comportamento al fuoco	Classe B ₁ -s1, d0 certificato CE di conformità N. 0497/CDP/4695/12	
Non contiene CFC (freon)	Legge N. 549 del 28/12/93	



codice	spessore (mm)	Ø (mm)	UM	min. ord. conf.	cat.	prezzo (€)
02206012P	6	12	MT	360	20	1,36
02206014P	6	14	MT	320	20	1,45
02206016P	6	15/16	MT	284	20	1,50
02206018P	6	18	MT	240	20	1,50
02206020P	6	20	MT	220	20	1,58
02206022P	6	22	MT	194	20	1,63
02206025P	6	25	MT	160	20	1,89
02206027P	6	27/28	MT	136	20	1,94
02206034P	6	34/35	MT	106	20	2,20
02206042P	6	42	MT	80	20	2,60

codice	spessore (mm)	Ø (mm)	UM	min. ord. conf.	cat.	prezzo (€)
022100220	10	22	MT	260	20	2,64
022100270	10	27/28	MT	220	20	2,82
022100340	10	34/35	MT	170	20	3,30
022100420	10	42	MT	126	20	3,96
022100480	10	48	MT	112	20	4,40
022100540	10	54	MT	90	20	5,06
022100600	10	60	MT	80	20	5,50
022100760	10	76	MT	56	20	7,92
022100880	10	88	MT	40	20	9,68

FASCIA PERIMETRALE

FASCIA PERIMETRALE ADESIVA CON BANDELLA, ROTOLO 50mt

Totalmente adesiva, di colore blu, in polietilene espanso elasticizzato chimico compatto a cellule chiuse.

DATI TECNICI

Temperatura massima d'esercizio (°C)	-20° +80°
Coefficiente di conducibilità termica (W/mK)	a 10° = 0,035 a 40° = 0,039
Isolamento al calpestio (dB) UNI EN ISO 140/6	da 20 a 25,5
Sollecitazione a compressione al 10% di deformazione (kPa)	13,002
Rigidità dinamica (MN/m ³)	41,0



codice	spessore (mm)	altezza (mm)	descrizione	UM	min. ord. conf.	cat.	prezzo (€)
6850001	8	150	5 pretagli	MT	1500	06	1,91
6850002	8	150	senza pretagli	MT	1500	06	1,91

DATI TECNICI

Temperatura d'impiego	-30 °C +130 °C
Densità	23 ÷ 28 Kg/m ³ tolleranza ±10%
Coefficiente di conducibilità termica	a +40 °C = 0,029 W/ (m x K)
Resistenza al fuoco della coppella con rivestimento in alluminio	Classe B _L -s1, dØ certificato CE di conformità N. 0497/CDP/4731/12
Resistenza al fuoco della coppella con rivestimento in PVC	Classe E _L certificato CE di conformità N. DE/4732/12
Stabilità dimensionale sulla lunghezza	% -0,001 a -25 °C / % -0,002 a +40 °C
Non contiene né freon né amianto	LeggeN. 549 del 28/12/93

TUBO ISOPIÙ RIVESTIMENTO PVC L. 1mt

Tubo in poliuretano espanso rivestito in PVC a chiusura autoadesiva



codice	spessore (mm)	Ø	UM	min. ord. conf.	cat.	prezzo (€)
PN0200220	20	22	MT	144	09	16,52
PN0200270	20	27	MT	112	09	17,08
PN0200340	20	34	MT	90	09	19,92
PN0200420	20	42	MT	70	09	22,48
PN0250480	25	48	MT	60	09	26,08
PN0250600	25	60	MT	40	09	28,76
PN0300760	30	76	MT	24	09	38,16
PN0300880	30	88	MT	22	09	45,00
PN0401140	40	114	MT	12	09	60,52

CURVA ISOPIÙ RIVESTIMENTO PVC

Curva in poliuretano espanso rivestito in PVC. Raggio della curvatura adatto per curve a saldare.



codice	spessore (mm)	Ø	UM	min. ord. conf.	cat.	prezzo (€)
PNC200220	20	22	NR	30	09	20,28
PNC200270	20	27	NR	30	09	22,76
PNC200340	20	34	NR	30	09	23,80
PNC200420	20	42	NR	20	09	24,96
PNC250480	25	48	NR	20	09	29,76
PNC250600	25	60	NR	15	09	35,72
PNC300760	30	76	NR	15	09	46,60
PNC300880	30	88	NR	15	09	53,12
PNC401140	40	114	NR	10	09	78,64

FOGLIA PVC IN ROTOLI

Spessore 23-27 micron.



codice	misura (mt)	UM	min. ord. conf.	cat.	prezzo (€)
066ISO2500	1 x 25	MQ	25	09	21,20

CATALOGO
LISTINO N° 8

**INDICE
PER CODICE
ARTICOLO**



INDICE PER CODICE ARTICOLO

codice	UM	cat.	euro	pag.	codice	UM	cat.	euro	pag.	codice	UM	cat.	euro	pag.
02206012P	MT	20	1,36	354	099150350	MT	20	3,96	353	1112101	NR	03	16,62	291
02206014P	MT	20	1,45	354	099150420	MT	20	4,40	353	1112103	NR	03	18,12	291
02206016P	MT	20	1,50	354	099150480	MT	20	4,97	353	1121001	NR	03	11,67	291
02206018P	MT	20	1,50	354	099150540	MT	20	6,25	353	115556	NR	13	2.697,57	47
02206020P	MT	20	1,58	354	099150600	MT	20	6,69	353	1201001	NR	09	24,40	291
02206022P	MT	20	1,63	354	099150760	MT	20	8,32	353	1201002	NR	09	26,76	291
02206025P	MT	20	1,89	354	099150880	MT	20	10,43	353	1201003	NR	09	29,00	291
02206027P	MT	20	1,94	354	099151140	MT	20	16,72	353	1202002	NR	09	22,32	291
02206034P	MT	20	2,20	354	099200220	MT	20	5,81	353	1203001	NR	09	14,28	291
02206042P	MT	20	2,60	354	099200280	MT	20	6,95	353	1203002	NR	09	16,12	291
022100220	MT	20	2,64	354	099200350	MT	20	8,76	353	1203003	NR	09	19,08	291
022100270	MT	20	2,82	354	099200420	MT	20	10,03	353	1204001	NR	09	7,04	291
022100340	MT	20	3,30	354	099200480	MT	20	11,18	353	1204002	NR	09	10,72	291
022100420	MT	20	3,96	354	099200600	MT	20	13,64	353	1207101	NR	05	47,74	229
022100480	MT	20	4,40	354	099200760	MT	20	17,38	353	1207102	NR	05	58,21	229
022100540	MT	20	5,06	354	099200880	MT	20	19,05	353	1207111	NR	05	61,31	229
022100600	MT	20	5,50	354	099201140	MT	20	28,47	353	1207112	NR	05	76,67	229
022100760	MT	20	7,92	354	1001004	NR	09	8,00	290	1207121	NR	05	145,92	229
022100880	MT	20	9,68	354	1001005	NR	09	7,84	290	1207134	NR	05	254,27	230
0661502500	MQ	09	21,20	355	1001006	NR	09	8,00	290	1207135	NR	05	445,06	230
07146000	NR	10	18,00	63	1002004	NR	09	8,64	290	1207136	NR	05	556,29	230
07147000	NR	10	33,01	63	1002005	NR	09	8,44	290	1207151	NR	11	527,54	230
099060120	MT	20	1,19	353	1002006	NR	09	8,64	290	1207152	NR	11	611,87	230
099060160	MT	20	1,32	353	1002007	NR	09	8,64	290	1207153	NR	11	713,46	230
099060180	MT	20	1,36	353	1002008	NR	09	8,64	290	1207154	NR	11	897,67	230
099060200	MT	20	1,54	353	1003005	NR	09	15,04	290	1207155	NR	11	1.074,28	230
099060220	MT	20	1,54	353	1003006	NR	09	15,04	290	1207159	NR	11	104,14	230
099060250	MT	20	1,76	353	1004003	NR	09	21,92	290	1207959	NR	05	19,84	229
099060270	MT	20	1,85	353	1004004	NR	09	21,92	290	13015215526	MT	21	7,11	349
099060280	MT	20	1,94	353	1011003	NR	09	8,48	290	13018215526	MT	21	7,75	349
099060320	MT	20	2,24	353	1011004	NR	09	8,40	290	13022215526	MT	21	8,25	349
099060340	MT	20	2,29	353	1011007	NR	09	8,40	290	13028215526	MT	21	9,12	349
099060350	MT	20	2,51	353	1011008	NR	09	8,40	290	13035215526	MT	21	11,70	349
099060420	MT	20	2,73	353	1012002	NR	09	8,80	290	13042215526	MT	21	13,00	349
099100160	MT	20	1,85	353	1012003	NR	09	8,60	290	1311001	NR	01	70,62	101
099100180	MT	20	1,89	353	1012004	NR	09	8,80	290	1316001	NR	01	131,67	100
099100200	MT	20	1,89	353	1012005	NR	09	9,16	290	1319001	NR	01	166,12	100
099100220	MT	20	1,89	353	1021001	NR	09	48,12	290	1319801	NR	01	279,68	100
099100250	MT	20	2,51	353	1021002	NR	09	48,12	290	1319901	NR	01	332,81	100
099100270	MT	20	2,60	353	1021004	NR	09	48,12	290	1320001	NR	01	67,91	101
099100280	MT	20	2,77	353	1021006	NR	09	48,44	290	1321001	NR	01	48,51	101
099100320	MT	20	2,82	353	1031009	NR	09	21,08	290	1322001	NR	01	36,63	102
099100340	MT	20	2,82	353	1031010	NR	09	21,08	290	1323001	NR	01	144,94	100
099100350	MT	20	3,04	353	1031011	NR	09	21,08	290	1324001	NR	01	240,54	80
099100420	MT	20	3,26	353	1031012	NR	09	21,08	290	1325001	NR	01	249,08	80
099100480	MT	20	3,65	353	1041002	NR	09	23,96	290	1350639	NR	05	232,00	96
099100540	MT	20	4,71	353	1041003	NR	09	26,36	290	1350649	NR	05	232,00	99
099100600	MT	20	4,97	353	1101003	NR	03	16,41	291	1350659	NR	05	246,40	98
099100640	MT	20	5,37	353	1101103	NR	03	18,15	291	1350703	NR	04	823,48	79
099100760	MT	20	6,60	353	1111003	NR	03	11,22	291	1350704	NR	04	823,48	78
099100880	MT	20	8,27	353	1111103	NR	03	12,60	291	1350902	NR	05	511,58	91
099150220	MT	20	2,64	353	1112001	NR	03	14,37	291	1350903	NR	05	654,78	89
099150280	MT	20	3,48	353	1112003	NR	03	13,11	291	1350907	NR	05	757,15	94

INDICE PER CODICE ARTICOLO

codice	UM	cat.	euro	pag.	codice	UM	cat.	euro	pag.	codice	UM	cat.	euro	pag.
1350908	NR	05	748,93	95	1403052	NR	01	133,88	104	1405835	NR	02	114,58	110
1350912	NR	05	654,78	88	1403053	NR	06	113,87	107	1405906	NR	02	89,93	110
1350913	NR	05	564,77	90	1403054	NR	06	123,37	106	1405911	NR	02	137,63	111
1350917	NR	05	736,64	93	1403055	NR	06	219,10	107	1405917	NR	02	129,44	111
1350918	NR	05	491,10	92	1403056	NR	06	226,30	106	1405935	NR	02	98,16	110
1350993	NR	05	44,10	125	1403057	NR	01	154,84	104	1405937	NR	02	86,05	111
1350996	NR	05	44,10	125	1403058	NR	06	68,04	106	1406003	NR	09	10,80	122
1350998	NR	05	44,10	125	1403059	NR	06	68,94	106	1406004	NR	09	11,92	122
1350999	NR	05	29,41	125	1403060	NR	01	302,73	104	1406011	NR	09	9,96	122
1358639	NR	04	373,98	97	1403063	NR	06	39,02	106	1406015	NR	09	8,84	122
1359639	NR	04	348,63	97	1403064	NR	06	39,02	106	1406016	NR	09	36,40	123
1401004	NR	02	4,49	119	1403065	NR	06	166,72	106	1406017	NR	09	55,44	123
1401005	NR	02	9,86	119	1403066	NR	06	169,13	107	1406023	NR	09	14,36	122
1401009	NR	02	94,15	119	1403068	NR	06	176,26	106	1406024	NR	09	17,16	122
1401010	NR	02	37,26	120-157	1403083	NR	06	163,30	106	1406030	NR	09	21,16	64
1401011	NR	02	59,53	119	1403084	NR	06	167,83	106	1406803	NR	15	53,43	122
1401012	NR	06	22,25	121	1403085	NR	15	404,67	105	1406815	NR	15	27,75	122
1401013	NR	02	10,10	121	1403086	NR	15	339,40	105	1406903	NR	15	38,85	122
1401014	NR	02	43,76	121	1403087	NR	06	194,40	107	1406915	NR	09	30,00	122
1401019	NR	02	13,97	121	1403088	NR	06	254,88	81	1407003	NR	09	13,24	122
1401020	NR	02	135,93	119	1403089	NR	06	273,46	81	1407006	NR	09	18,76	122
1401021	NR	23	2,58	123	1403818	NR	01	193,55	104	1407012	NR	09	25,76	122
1401022	NR	02	37,03	121	1403821	NR	01	185,96	104	1407013	NR	09	30,04	122
1401024	NR	02	6,97	121	1403852	NR	01	278,95	104	1407014	NR	09	20,28	123
1401027	NR	02	21,52	120-157	1403857	NR	01	277,04	104	1407903	NR	09	16,32	122
1401033	NR	02	142,46	120-157	1403918	NR	01	175,33	104	1409002	NR	02	31,99	117
1401034	NR	02	144,84	120-157	1403921	NR	01	167,38	104	1409004	NR	02	63,48	116
1401036	NR	02	51,85	120-157	1403924	NR	01	337,76	104	1409005	NR	02	55,17	116
1401037	NR	02	37,84	121	1403952	NR	01	227,14	104	1409007	NR	02	39,61	117
14018217526KR	MT	02	17,34	349	1403957	NR	01	247,07	104	1409008	NR	02	39,61	116
1401834	NR	02	299,57	120	1404011	NR	02	19,18	124	1409009	NR	02	11,90	118
1401934	NR	02	306,31	120	1405001	NR	02	37,33	109	1409010	NR	02	84,05	115
14022217526KR	MT	02	19,82	349	1405004	NR	06	15,70	110	1409011	NR	02	66,37	116
1403006	NR	02	10,91	109	1405005	NR	06	18,83	110	1409012	NR	02	79,63	115
1403009	NR	06	17,57	108	1405006	NR	02	34,48	110	1409013	NR	02	61,95	116
1403017	NR	02	18,33	108	1405007	NR	02	91,77	110	1409014	NR	02	31,62	117
1403018	NR	01	117,15	104	1405011	NR	02	66,47	111	1409021	NR	02	79,63	115
1403020	NR	01	140,18	104	1405013	NR	02	35,74	111	1409022	NR	02	75,24	115
1403021	NR	01	92,07	104	1405014	NR	02	47,04	111	1409024	NR	02	39,70	117
1403024	NR	01	170,94	104	1405017	NR	02	65,21	111	1409025	NR	02	46,11	117
1403033	NR	06	44,93	106	1405018	NR	02	71,91	111	1409027	NR	02	57,12	82
1403034	NR	06	86,18	106	1405019	NR	02	47,63	110	1409507	NR	02	57,12	82
1403035	NR	06	45,83	106	1405021	NR	06	17,46	110	1409510	NR	02	138,62	82
1403037	NR	01	184,11	104	1405024	NR	02	73,24	110	1409512	NR	02	127,57	82
1403040	NR	02	12,24	108	1405035	NR	02	38,25	110	1409808	NR	02	68,54	116
1403041	NR	06	90,72	106	1405036	NR	02	143,28	109	1409809	NR	02	33,46	118
1403042	NR	01	209,22	104	1405037	NR	02	59,26	111	1409810	NR	02	180,54	115
1403046	NR	02	43,49	107	1405038	NR	02	83,95	111	1409812	NR	02	144,43	115
1403047	NR	02	32,03	107	1405040	NR	02	145,66	81	1409908	NR	02	65,28	116
1403048	NR	06	13,50	108	1405041	NR	02	96,70	81	1409909	NR	02	49,30	118
1403049	NR	02	26,04	109	1405806	NR	02	100,10	110	1409910	NR	02	160,07	115
1403050	NR	02	390,46	105	1405811	NR	02	150,14	111	1409912	NR	02	164,29	115
1403051	NR	02	373,69	105	1405817	NR	02	143,11	111	1410002	NR	06	47,74	112

INDICE PER CODICE ARTICOLO

codice	UM	cat.	euro	pag.	codice	UM	cat.	euro	pag.	codice	UM	cat.	euro	pag.
1410003	NR	06	15,98	112	1431018	NR	03	197,61	85	1510202	NR	05	8,06	311
1410019	NR	06	14,29	113	1431021	NR	03	206,78	86	1510203	NR	05	14,18	311
1410021	NR	06	25,27	113	1431024	NR	03	263,22	86	1511001	NR	05	7,26	310
1410023	NR	06	30,42	112	1431815	NR	03	245,29	87	1511002	NR	05	12,83	310
1410024	NR	06	10,33	113	1431816	NR	03	321,08	86	1511003	NR	05	19,78	310
1410025	NR	06	13,08	113	1431818	NR	03	276,66	85	1511004	NR	01	21,75	310
1410028	NR	06	28,58	112	1431915	NR	03	236,48	87	1511005	NR	01	51,88	310
1410030	NR	06	20,59	112	1431916	NR	03	309,61	86	1511006	NR	01	131,77	310
1410034	NR	06	13,86	112	1431918	NR	03	266,78	85	1511007	NR	01	6,01	310
1410036	NR	06	20,52	114	1434001	NR	03	201,24	52	1512004	NR	01	24,52	306
1410928	NR	06	50,54	112	1434007	NR	03	120,00	53	1512005	NR	01	30,53	306
1411003	NR	02	8,13	123	1434013	NR	03	235,42	55	1512006	NR	01	47,95	306
1411004	NR	02	11,15	123	1501004	NR	01	18,32	306	1512107	NR	01	120,85	306
1411007	NR	02	13,50	123	1501005	NR	01	25,08	306	1513000	NR	01	3,14	306
1411907	NR	02	23,09	123	1501006	NR	01	41,78	306	1513001	NR	04	5,15	306
1412001	NR	06	32,90	114	1501107	NR	01	91,01	306	1513002	NR	04	7,94	306
1412002	NR	06	39,56	114	1502000	NR	01	2,74	306	1513003	NR	04	12,37	306
1412003	NR	06	25,52	69-114	1502001	NR	04	3,69	306	1513004	NR	01	4,09	306
1412004	NR	02	48,82	118	1502002	NR	04	6,20	306	1513201	NR	05	3,42	311
1412008	NR	06	14,29	114	1502003	NR	04	10,08	306	1513202	NR	05	6,21	311
1412009	NR	06	18,61	114	1502004	NR	01	3,50	306	1513203	NR	05	9,95	311
1412012	NR	02	12,14	119	1502201	NR	05	2,85	311	1514000	NR	01	6,30	306
1412014	NR	02	42,50	118	1502202	NR	05	4,93	311	1514001	NR	01	8,71	306
1412015	NR	02	34,99	118	1502203	NR	05	8,06	311	1514002	NR	01	9,87	306
1412016	NR	02	44,54	117	1503001	NR	01	7,72	306	1514003	NR	01	13,99	306
1412501	NR	06	45,36	81	1503003	NR	01	11,35	306	1514005	NR	01	18,35	306
1412502	NR	06	50,33	81	1503004	NR	01	5,15	306	1514006	NR	01	11,12	306
1412808	NR	06	56,16	114	1504004	NR	01	19,31	306	1514007	NR	01	26,37	306
1412908	NR	06	51,84	114	1504005	NR	01	24,16	306	1514009	NR	01	16,93	306
1413028	NR	02	16,49	69	1504006	NR	01	39,27	306	1514010	NR	01	20,79	306
1413029	NR	09	19,88	70	1504107	NR	01	105,11	306	1514011	NR	01	22,97	306
1413069	NR	09	19,80	70	1505000	NR	01	2,51	306	1514012	NR	01	28,05	306
1413084	NR	09	23,64	64	1505001	NR	04	3,75	306	1514013	NR	01	30,49	306
1413085	NR	09	8,84	64	1505002	NR	04	5,92	306	1514014	NR	01	36,47	306
1413086	NR	09	24,84	64	1505003	NR	04	9,77	306	1515001	NR	01	9,87	307
1413089	NR	09	31,52	64	1505004	NR	01	3,23	306	1515002	NR	01	14,55	307
1413091	NR	09	31,52	64	1505201	NR	05	3,14	311	1515003	NR	01	21,78	307
1413095	NR	09	19,00	64	1505202	NR	05	4,83	311	1515104	NR	01	35,48	307
1414009	NR	02	43,23	124	1505203	NR	05	8,58	311	1515105	NR	01	55,21	307
1414012	NR	02	55,76	124	1508001	NR	01	12,47	310	1515106	NR	01	84,38	307
1414016	NR	02	32,39	124	1508002	NR	01	19,40	310	1516001	NR	01	3,47	307
1414017	NR	04	42,97	124	1508003	NR	01	24,82	310	1516002	NR	01	4,42	307
1414809	NR	02	60,51	124	1509001	NR	01	8,81	310	1516003	NR	01	7,36	307
1414812	NR	02	78,05	124	1509002	NR	01	13,43	310	1516004	NR	01	11,65	307
1414909	NR	02	60,51	124	1509003	NR	01	20,26	310	1516005	NR	01	14,65	307
1414912	NR	02	78,05	124	1510000	NR	01	5,41	310	1516006	NR	01	21,22	307
1430007	NR	03	159,46	87	1510001	NR	05	6,59	310	1516007	NR	01	2,18	307
1430807	NR	03	223,41	87	1510002	NR	05	10,21	310	1516008	NR	01	2,71	307
1430907	NR	03	215,49	87	1510003	NR	05	14,98	310	1516201	NR	05	2,14	311
1431014	NR	03	91,21	87	1510004	NR	01	25,18	310	1516202	NR	05	3,30	311
1431015	NR	03	175,20	87	1510005	NR	01	46,86	310	1516203	NR	05	5,18	311
1431016	NR	03	229,36	86	1510006	NR	01	83,89	310	1517001	NR	01	2,84	307
1431017	NR	03	140,15	87	1510201	NR	05	5,38	311	1517002	NR	01	3,99	307

INDICE PER CODICE ARTICOLO

codice	UM	cat.	euro	pag.	codice	UM	cat.	euro	pag.	codice	UM	cat.	euro	pag.
1517003	NR	01	6,11	307	1522002	NR	01	1,95	308	1525215	NR	05	13,15	312
1517004	NR	01	7,00	307	1522003	NR	01	3,10	308	1525216	NR	05	1,95	312
1517005	NR	01	9,93	307	1522004	NR	01	5,61	308	1526301	NR	05	2,46	312
1517007	NR	01	15,87	307	1522005	NR	01	7,06	308	1526302	NR	05	2,53	312
1517009	NR	01	21,29	307	1522006	NR	01	14,39	308	1526304	NR	05	3,74	312
1517011	NR	01	9,31	307	1522007	NR	01	0,99	308	1526305	NR	05	3,81	312
1517202	NR	05	2,46	311	1522201	NR	05	1,22	312	1526306	NR	05	3,94	312
1517203	NR	05	3,52	311	1522202	NR	05	1,82	312	1526307	NR	05	4,22	312
1517204	NR	05	3,90	311	1522203	NR	05	2,88	312	1526308	NR	05	4,51	312
1518004	NR	01	8,25	307	1523001	NR	01	2,24	308	1526309	NR	05	5,66	312
1518005	NR	01	10,92	307	1523002	NR	01	3,73	308	1526310	NR	05	6,88	312
1518006	NR	01	19,40	307	1523003	NR	01	5,28	308	1526311	NR	05	7,94	312
1518010	NR	01	1,25	307	1523007	NR	01	1,42	308	1526312	NR	05	15,81	312
1518011	NR	01	1,58	307	1523104	NR	01	6,34	308	1527300	NR	05	2,53	312
1518107	NR	01	24,72	307	1523105	NR	01	11,09	308	1527302	NR	05	3,04	312
1519001	NR	04	1,98	307	1523106	NR	01	18,05	308	1527306	NR	05	4,93	312
1519002	NR	04	3,01	307	1525000	NR	01	0,79	307	1527307	NR	05	7,78	312
1519003	NR	04	4,99	307	1525001	NR	01	2,01	307	1528001	NR	01	0,92	309
1519200	NR	05	1,15	311	1525002	NR	01	1,35	307	1528002	NR	01	1,29	309
1519201	NR	05	1,57	311	1525003	NR	01	2,31	307	1528003	NR	01	1,95	309
1519202	NR	05	2,37	311	1525004	NR	01	4,46	307	1528004	NR	01	3,33	309
1519203	NR	05	3,74	311	1525005	NR	01	3,56	307	1528105	NR	01	3,23	309
1520000	NR	01	1,16	308	1525006	NR	01	8,75	307	1529001	NR	21	15,12	317
1520001	NR	01	1,91	308	1525007	NR	01	7,36	307	1529002	NR	21	21,17	317
1520002	NR	01	3,14	308	1525008	NR	01	5,94	307	1529003	NR	21	33,14	317
1520003	NR	01	4,82	308	1525009	NR	01	10,86	307	1529004	NR	21	47,58	317
1520004	NR	01	5,31	308	1525010	NR	01	9,04	307	1529005	NR	21	59,77	317
1520005	NR	01	7,95	308	1525011	NR	01	6,70	307	1529006	NR	21	89,68	317
1520006	NR	01	10,30	308	1525012	NR	01	16,57	307	1529007	NR	21	129,92	317
1520007	NR	01	10,86	308	1525013	NR	01	15,51	307	1529008	NR	21	164,58	317
1520009	NR	01	20,20	308	1525014	NR	01	12,97	307	1530001	NR	21	9,16	317
1520010	NR	01	1,62	308	1525015	NR	01	0,99	307	1530002	NR	21	14,59	317
1520011	NR	01	2,48	308	1525016	NR	01	2,71	307	1530003	NR	21	21,43	317
1520012	NR	01	3,04	308	1525020	NR	01	4,92	307	1530004	NR	21	35,26	317
1520013	NR	01	8,25	308	1525021	NR	01	12,01	307	1530005	NR	21	46,36	317
1520014	NR	01	10,03	308	1525022	NR	01	20,06	307	1530006	NR	21	76,91	317
1520018	NR	01	20,53	308	1525024	NR	01	40,29	307	1530009	NR	21	143,91	317
1520116	NR	01	39,73	308	1525025	NR	01	48,44	307	1531101	NR	21	12,16	318
1520201	NR	05	1,44	311	1525027	NR	01	3,00	307	1531102	NR	21	16,49	318
1520202	NR	05	2,21	311	1525028	NR	01	1,29	307	1531103	NR	21	24,09	318
1520203	NR	05	3,26	311	1525123	NR	01	27,19	307	1531104	NR	21	31,69	318
1520204	NR	05	3,26	311	1525201	NR	05	1,31	312	1531105	NR	21	46,51	318
1521001	NR	01	1,16	308	1525202	NR	05	0,90	312	1531106	NR	21	66,73	318
1521002	NR	01	1,42	308	1525203	NR	05	1,47	312	1531107	NR	21	111,23	318
1521003	NR	01	2,05	308	1525204	NR	05	3,17	312	1532001	NR	01	1,55	309
1521004	NR	01	3,04	308	1525205	NR	05	2,37	312	1532002	NR	01	2,28	309
1521005	NR	01	4,49	308	1525207	NR	05	0,77	312	1532003	NR	01	3,14	309
1521203	NR	05	0,93	312	1525208	NR	05	5,79	312	1532004	NR	01	4,09	309
1521204	NR	05	1,57	312	1525209	NR	05	4,96	312	1532005	NR	01	5,05	309
1521205	NR	05	2,75	312	1525210	NR	05	4,00	312	1532009	NR	01	4,03	309
1521206	NR	05	4,74	312	1525211	NR	05	9,28	312	1532011	NR	01	5,54	309
1522000	NR	01	0,96	308	1525213	NR	05	6,24	312	1532012	NR	01	6,96	309
1522001	NR	01	1,35	308	1525214	NR	05	4,35	312	1532013	NR	01	8,02	309

INDICE PER CODICE ARTICOLO

codice	UM	cat.	euro	pag.	codice	UM	cat.	euro	pag.	codice	UM	cat.	euro	pag.
1532014	NR	01	2,84	309	1535000	NR	01	4,49	309	1544001	NR	01	1,72	308
1532015	NR	01	3,47	309	1535001	NR	01	5,64	309	1544002	NR	01	1,88	308
1532016	NR	01	3,96	309	1535002	NR	01	8,68	309	1544003	NR	01	2,31	308
1532017	NR	01	5,41	309	1535003	NR	01	7,43	309	1544004	NR	01	3,63	308
1532018	NR	01	7,52	309	1535004	NR	01	11,98	309	1544005	NR	01	6,11	308
1532019	NR	01	8,45	309	1535005	NR	01	10,46	309	1544006	NR	01	9,14	308
1532021	NR	01	4,39	309	1535006	NR	01	15,81	309	1544007	NR	01	11,06	308
1532022	NR	01	4,72	309	1535008	NR	01	25,48	309	1544008	NR	01	19,21	308
1532023	NR	01	6,30	309	1535009	NR	01	32,34	309	1545001	NR	01	11,85	310
1532024	NR	01	7,85	309	1535010	NR	01	18,58	309	1545002	NR	01	19,01	310
1532025	NR	01	1,85	309	1535011	NR	01	23,96	309	1545003	NR	01	19,57	310
1532026	NR	01	2,90	309	1535012	NR	01	35,01	309	1545005	NR	01	25,58	310
1532027	NR	01	9,83	309	1535013	NR	01	6,57	309	1546001	NR	01	10,23	310
1532028	NR	01	10,46	309	1535014	NR	01	11,39	309	1546002	NR	01	14,45	310
1532029	NR	01	12,71	309	1535015	NR	01	13,13	309	1546003	NR	01	23,56	310
1532030	NR	01	5,12	309	1535016	NR	01	15,64	309	1546004	NR	01	30,10	310
1532031	NR	01	7,69	309	1535017	NR	01	6,70	309	1546005	NR	01	41,48	310
1532032	NR	01	11,45	309	1535018	NR	01	10,07	309	1546006	NR	01	60,32	310
1532033	NR	01	13,27	309	1535019	NR	01	17,09	309	1550001	NR	01	8,35	308
1532034	NR	01	15,68	309	1535020	NR	01	18,45	309	1550002	NR	01	10,82	308
1532211	NR	05	5,60	312	1535021	NR	01	22,31	309	1560001	NR	06	4,61	229
1532212	NR	05	6,75	312	1535022	NR	01	9,41	309	1560002	NR	06	9,50	229
1532214	NR	05	2,50	312	1535023	NR	01	13,93	309	1601000	NR	01	3,86	304
1532215	NR	05	2,98	312	1535025	NR	01	27,92	309	1601001	NR	01	4,95	304
1532216	NR	05	3,46	312	1535026	NR	01	35,54	309	1601002	NR	01	5,61	304
1532217	NR	05	4,58	312	1535029	NR	01	37,13	309	1601003	NR	01	9,27	304
1532221	NR	05	6,85	312	1535031	NR	01	52,87	309	1601004	NR	01	14,59	304
1533001	NR	01	2,08	309	1535035	NR	01	44,75	309	1602000	NR	01	4,03	304
1533002	NR	01	2,71	309	1535037	NR	01	63,86	309	1602001	NR	01	4,72	304
1533003	NR	01	3,27	309	1535038	NR	01	23,30	309	1602002	NR	01	5,38	304
1533004	NR	01	4,42	309	1536001	NR	21	14,86	318	1602003	NR	01	9,14	304
1533201	NR	05	1,63	312	1537000	NR	01	0,99	308	1602004	NR	01	14,29	304
1533202	NR	05	2,08	312	1537001	NR	01	1,72	308	1603000	NR	01	4,55	304
1533203	NR	05	2,50	312	1537002	NR	01	2,44	308	1603001	NR	01	5,71	304
1533204	NR	05	3,39	312	1537003	NR	01	4,29	308	1603002	NR	01	6,47	304
1533206	NR	05	4,13	312	1537004	NR	01	1,39	308	1603003	NR	01	10,82	304
1534000	NR	01	1,58	309	1537005	NR	01	6,53	308	1603004	NR	01	16,43	304
1534001	NR	01	3,00	309	1537006	NR	01	10,13	308	1604001	NR	01	2,77	304
1534002	NR	01	4,06	309	1537007	NR	01	16,27	308	1604002	NR	01	3,63	304
1534003	NR	01	5,31	309	1540000	NR	04	17,92	318	1604003	NR	01	4,65	304
1534004	NR	01	6,04	309	1540001	NR	04	20,18	318	1604004	NR	01	8,25	304
1534005	NR	01	1,78	309	1540002	NR	04	25,39	318	1604005	NR	01	2,77	304
1534006	NR	01	2,05	309	1540003	NR	04	32,24	318	1605000	NR	01	1,72	304
1534007	NR	01	3,07	309	1540004	NR	04	49,82	318	1605001	NR	01	1,88	304
1534008	NR	01	5,71	309	1540005	NR	04	62,50	318	1605002	NR	01	2,44	304
1534009	NR	01	5,41	309	1540006	NR	04	96,04	318	1605003	NR	01	3,99	304
1534010	NR	01	8,22	309	1541001	NR	04	20,18	318	1605004	NR	01	6,96	304
1534201	NR	05	1,66	312	1541002	NR	04	25,39	318	1606000	NR	01	1,58	305
1534202	NR	05	2,69	312	1541003	NR	04	32,24	318	1606001	NR	01	2,44	305
1534203	NR	05	4,16	312	1541004	NR	04	49,82	318	1606002	NR	01	3,96	305
1534204	NR	05	4,16	312	1541005	NR	04	62,50	318	1606003	NR	01	1,98	305
1534211	NR	05	7,14	312	1541006	NR	04	96,04	318	1606004	NR	01	6,77	305
1534212	NR	05	8,58	312	1541007	NR	04	17,92	318	1606005	NR	01	3,00	305

INDICE PER CODICE ARTICOLO

codice	UM	cat.	euro	pag.	codice	UM	cat.	euro	pag.	codice	UM	cat.	euro	pag.
1606006	NR	01	3,86	305	1614103	NR	01	9,21	304	2005178	NR	04	29,76	149
1606007	NR	01	6,57	305	19015215526	MT	21	13,00	349	2006002	NR	06	11,74	224
1607000	NR	01	1,16	305	19018215526	MT	21	13,57	349	2006004	KG	06	39,71	224
1607001	NR	01	1,75	305	19022215526	MT	21	15,39	349	2006010	NR	02	19,75	227-241
1607002	NR	01	2,81	305	19028215526	MT	21	18,43	349	2006011	NR	02	25,94	227-241
1607003	NR	01	4,95	305	19035215526	MT	21	21,28	349	2006012	NR	06	9,97	227
1607006	NR	01	1,58	305	19042215526	MT	21	23,98	349	2006013	NR	06	14,29	227
1607007	NR	01	1,42	305	1911001	NR	02	9,42	317	2006014	NR	04	78,43	285
1607008	NR	01	2,48	305	1911002	NR	02	10,91	317	2006015	NR	04	26,94	285
1607009	NR	01	3,89	305	1911003	NR	02	14,69	317	2006018	NR	22	48,68	285
1607010	NR	01	3,33	305	1911004	NR	02	20,23	317	2006019	NR	04	18,76	285
1607011	NR	01	6,30	305	1911005	NR	02	31,82	317	2006020	NR	06	26,46	222
1607012	NR	01	5,74	305	1911006	NR	02	46,65	317	2006024	NR	05	19,29	228
1608001	NR	01	3,86	305	1911007	NR	02	67,42	317	2006025	NR	06	18,18	224
1608002	NR	01	4,75	305	1911008	NR	02	143,04	317	2006029	NR	02	10,30	224
1608008	NR	01	7,49	305	1911009	NR	02	208,35	317	2006030	NR	02	29,82	226
1609000	NR	01	2,61	305	1912003	NR	09	2,32	317	2006031	NR	02	29,82	226
1609001	NR	01	2,71	305	1912004	NR	09	2,88	317	2006032	NR	02	6,46	228
1609002	NR	01	3,20	305	1912005	NR	09	3,52	317	2006033	NR	02	9,72	228
1609003	NR	01	3,73	305	1912006	NR	09	4,16	317	2006034	NR	02	8,98	227
1609004	NR	01	5,08	305	1912007	NR	09	5,44	317	2006035	NR	02	9,72	228
1609005	NR	01	6,20	305	1912008	NR	09	9,80	317	2006091	NR	03	104,46	50
1609006	NR	01	8,32	305	1913002	NR	21	19,34	317	2006092	NR	03	5,01	50
1609007	NR	01	2,21	305	1913003	NR	21	24,40	317	2006098	NR	03	99,00	50-71
1609009	NR	01	2,97	305	1913004	NR	21	37,47	317	2006099	NR	11	252,65	48-49
1609010	NR	01	10,43	305	1914003	NR	21	18,09	317	2006300	NR	22	0,50	225
1609012	NR	01	17,13	305	1914004	NR	21	27,82	317	2006301	NR	22	0,59	225
1609015	NR	01	3,89	305	20018217526KR	MT	02	19,82	349	2006304	NR	22	0,80	225
1609016	NR	01	4,39	305	20022217526KR	MT	02	22,81	349	2006305	NR	22	1,18	225
1609017	NR	01	5,05	305	20028217526KR	MT	02	26,38	349	2006307	NR	22	2,56	225
1609018	NR	01	6,63	305	2005013	NR	24	39,92	221	2006308	NR	22	4,33	225
1609019	NR	01	4,59	305	2005015	NR	23	13,20	220	2006311	NR	19	7,82	226
1609021	NR	01	11,48	305	2005016	NR	23	21,90	220	2006312	NR	19	7,82	226
1609022	NR	01	13,00	305	2005030	NR	21	8,36	223	2006313	NR	19	6,99	226
1609024	NR	01	3,70	305	2005031	NR	21	10,07	223	2006322	NR	22	2,94	225
1609025	NR	01	5,08	305	2005040	NR	21	11,51	223	2006323	NR	22	2,94	225
1609026	NR	01	5,71	305	2005041	NR	21	13,22	223	2006330	NR	22	1,47	225
1609027	NR	01	6,80	305	2005050	NR	21	16,53	223	2006340	NR	19	11,55	225-241-352
1609028	NR	01	7,72	305	2005051	NR	21	16,95	223	2006341	NR	19	6,95	225-241-352
1609029	NR	01	9,83	305	2005073	NR	04	29,76	149	2006346	NR	19	8,19	226
1609030	NR	01	11,29	305	2005074	NR	04	29,76	149	2006350	NR	19	23,28	224-352
1611000	NR	01	1,58	305	2005075	NR	04	29,76	149	2006361	NR	04	27,44	223
1611001	NR	01	1,88	305	2005076	NR	04	29,76	149	2006363	NR	04	137,14	223
1611002	NR	01	2,87	305	2005077	NR	04	29,76	149	2006372	NR	02	17,24	223
1611003	NR	01	3,86	305	2005078	NR	04	29,76	149	2006373	NR	02	4,08	223
1611004	NR	01	1,22	305	2005079	NR	04	29,76	149	2006374	NR	02	5,47	223
1612000	NR	01	1,52	305	2005084	NR	21	24,89	223	2006380	NR	05	19,10	224
1612001	NR	01	1,95	305	2005090	NR	08	8,19	224	2006381	NR	05	32,06	224
1612002	NR	01	2,71	305	2005173	NR	04	29,76	149	2006382	NR	05	36,45	227
1612003	NR	01	4,09	305	2005174	NR	04	29,76	149	2006383	NR	21	4,90	227
1612004	NR	01	6,27	305	2005175	NR	04	29,76	149	2006384	NR	21	10,94	227
1614001	NR	01	5,45	304	2005176	NR	04	29,76	149	2006385	NR	21	7,98	224
1614002	NR	01	8,42	304	2005177	NR	04	29,76	149	2006390	NR	06	9,11	228

INDICE PER CODICE ARTICOLO

codice	UM	cat.	euro	pag.	codice	UM	cat.	euro	pag.	codice	UM	cat.	euro	pag.
2006391	NR	06	10,30	228	2009017	NR	05	82,75	222	2012834	NR	22	17,18	234
2006410	NR	19	15,59	226	2009020	NR	15	23,61	232	2012847	NR	22	14,74	234
2006413	NR	09	18,20	226	2009021	NR	15	37,11	232	2012890	NR	22	26,96	233
2006415	NR	19	19,87	226	2009041	NR	15	23,61	232	2012891	NR	22	38,60	233
2006601	NR	23	1,86	220	2009055	NR	15	33,74	231	2101001	NR	05	22,69	181
2006602	NR	23	1,08	220	2009060	NR	15	64,12	231	2101002	NR	05	19,65	181
2006603	NR	23	2,10	220	2009071	NR	15	18,20	232	2101011	NR	05	29,54	181
2006604	NR	23	1,92	220	2009081	NR	15	16,54	232	2102001	NR	05	22,69	181
2006605	NR	23	1,20	220	2009092	NR	15	21,94	232	2102002	NR	05	19,65	181
2006606	NR	23	0,90	220	2009100	NR	09	14,36	231	2102101	NR	05	29,54	181
2006607	NR	14	4,60	219	2009101	NR	09	14,08	231	2103001	NR	05	22,69	181
2006608	NR	14	0,95	219	2009102	NR	09	19,76	231	2103002	NR	05	19,65	181
2006621	NR	23	1,38	220	2009103	NR	09	33,20	231	2103003	NR	05	29,54	182
2007010	NR	03	44,22	286	2009120	NR	04	26,66	231	2105001	NR	01	9,11	184
2007011	NR	03	44,22	286	2009121	NR	04	33,20	231	2105101	NR	01	9,37	184
2007012	NR	09	14,96	286	2009122	NR	04	68,51	231	2106002	NR	01	26,86	72-192
2007013	NR	09	27,28	286	2009165	NR	04	25,76	231	2106003	NR	01	26,86	72-192
2007015	NR	09	21,12	286	2009166	NR	04	32,27	231	2106007	NR	01	11,25	192
2007019	NR	03	178,20	286	2009170	NR	09	3,76	231	2106008	NR	01	11,72	192
2007023	NR	09	60,08	286	2009171	NR	09	5,04	231	2106012	NR	01	33,43	192
2007030	NR	09	8,48	286	2009172	NR	09	10,36	231	2106013	NR	01	33,43	192
2007055	NR	06	65,34	287	2009201	NR	11	335,07	288	2106015	NR	01	32,08	192
2007059	NR	06	118,40	287	2009202	NR	11	335,07	288	2106020	NR	01	34,78	191
2008050	NR	01	19,98	253	2009203	NR	11	367,69	288	2106025	NR	01	12,05	192
2008051	NR	01	195,60	252	2009204	NR	11	367,69	288	2106029	NR	01	42,50	191
2008052	NR	01	107,90	253	2012001	NR	22	15,92	233	2106034	NR	01	12,47	192
2008054	NR	01	250,38	252	2012002	NR	22	16,84	233	2106035	NR	01	38,28	191
2008055	NR	01	286,17	252	2012003	NR	22	25,75	233	2106037	NR	01	32,51	191
2008056	NR	01	618,80	252	2012004	NR	22	36,79	233	2106101	NR	01	11,25	192
2008057	NR	01	653,65	252	2012005	NR	22	76,31	233	2106102	NR	01	11,72	192
2008058	NR	01	268,76	252	2012006	NR	22	92,48	233	2106437	NR	01	52,34	191
2008059	NR	01	296,22	252	2012007	NR	22	134,65	233	2106500	NR	01	60,06	72-191
2008060	NR	01	618,80	252	2012101	NR	22	42,84	234	2106537	NR	01	59,04	191
2008061	NR	01	653,65	252	2012102	NR	22	46,03	234	2106637	NR	01	59,04	191
2008062	NR	01	187,15	253	2012201	NR	22	16,51	233	2106737	NR	01	67,29	191
2008063	NR	01	188,86	253	2012202	NR	22	19,11	233	2106837	NR	01	100,91	191
2008064	NR	01	66,16	253	2012203	NR	22	18,31	233	2106929	NR	01	87,38	191
2008065	NR	01	9,00	253	2012401	NR	22	26,54	234	2106937	NR	01	67,29	191
2008090	NR	11	90,83	247	2012501	NR	20	2,86	235	2201001	NR	01	18,18	193
2008091	NR	11	43,85	247	2012601	NR	20	4,88	235	2201002	NR	01	9,50	193
2008092	NR	11	84,56	247	2012602	NR	20	6,07	235	2201101	NR	01	14,95	193
2008093	NR	11	43,85	247	2012603	NR	20	8,71	235	2201102	NR	01	7,19	193
2008094	NR	11	34,45	247	2012604	NR	20	23,98	235	2201103	NR	01	7,00	193
2008095	NR	11	31,32	247	2012701	NR	20	1,63	235	2201201	NR	01	9,64	194
2008096	NR	11	106,49	247	2012711	NR	20	17,91	235	2201202	NR	01	27,72	194
2009000	NR	05	42,02	222	2012722	NR	20	44,70	235	2202001	NR	01	6,34	194
2009003	NR	05	53,73	222	2012723	NR	20	64,37	235	2202002	NR	01	6,86	194
2009004	NR	05	52,32	222	2012821	NR	22	71,19	235	2202003	NR	01	5,71	194
2009005	NR	05	56,70	222	2012822	NR	22	73,92	235	2203001	NR	01	15,38	185
2009008	NR	05	166,21	222	2012823	NR	22	144,61	235	2203101	NR	01	20,20	185
2009009	NR	05	57,79	222-288	2012824	NR	22	151,03	235	2204102	NR	01	9,77	185
2009010	NR	22	60,48	231	2012825	NR	22	240,49	235	2204103	NR	01	16,37	185
2009011	NR	22	60,48	231	2012833	NR	22	14,32	234	2204104	NR	01	17,79	184

INDICE PER CODICE ARTICOLO

codice	UM	cat.	euro	pag.	codice	UM	cat.	euro	pag.	codice	UM	cat.	euro	pag.
2204106	NR	01	20,06	184	2601009	NR	05	23,39	182	2651062	NR	24	16,40	221
2205102	NR	01	9,90	185	2601013	NR	05	126,18	180	2651070	NR	24	4,32	221
2205104	NR	01	15,21	185	2601016	NR	05	101,54	180	2651072	NR	24	4,32	221
2302101	NR	01	26,10	190	2601017	NR	05	92,16	180	2651080	NR	09	10,16	196
2302102	NR	01	14,29	190	2601018	NR	05	54,98	180	2651081	NR	09	5,04	196
2302104	NR	01	15,11	190	2601020	NR	05	55,94	183	2651082	NR	09	6,80	196
2303007	NR	01	29,04	189	2601021	NR	05	20,77	183	26594000	NR	11	403,68	102
2303008	NR	01	34,49	189	2601024	NR	05	20,77	183	2661001	NR	20	2,95	197
2303009	NR	01	24,59	189	2601025	NR	05	20,77	183	2661002	NR	20	2,95	197
2303010	NR	01	20,69	189	2601027	NR	05	34,53	183	2661006	NR	20	2,95	218
2303012	NR	01	36,17	189	2601028	NR	05	22,94	183	2661011	NR	20	6,25	198
2303711	NR	01	78,24	189	2601030	NR	05	165,76	180	2661013	NR	20	4,80	206
2303911	NR	01	78,24	189	2601718	NR	05	114,24	180	2661014	NR	20	2,95	206
2304309	NR	01	65,34	190	2601818	NR	05	204,64	180	2661017	NR	20	3,43	206-241
2304317	NR	01	15,81	193	2601917	NR	05	202,88	180	2661021	NR	23	0,42	282
2304801	NR	04	72,01	187	2601918	NR	05	114,24	180	2661027	NR	20	2,68	197
2304802	NR	04	164,30	187	2602007	NR	01	11,32	184	2661028	NR	20	2,68	197
2304950	NR	04	203,42	186	2602015	NR	01	9,64	194	2661029	NR	20	9,28	197
2304951	NR	04	341,00	186	2651001	NR	09	5,32	195	2661030	NR	20	17,64	197
2304952	NR	04	359,79	186	2651002	NR	09	6,04	195	2661033	NR	20	9,59	198
2304953	NR	04	414,47	186	2651003	NR	09	6,04	195	2661049	NR	09	5,68	195
2304954	NR	04	319,95	186	2651005	NR	09	38,88	196	2661050	NR	09	6,52	195
2304955	NR	04	319,95	186	2651016	NR	09	13,76	195	2661051	NR	09	6,72	195
2304960	NR	04	125,15	186	2651017	NR	09	17,24	195	2661053	NR	09	7,52	196
2304963	NR	04	187,67	186	2651018	NR	09	6,16	195	2661054	NR	09	9,12	196
2304964	NR	04	211,17	186	2651019	NR	09	7,20	195	2661057	NR	20	4,27	198
2304965	NR	04	234,64	186	2651020	NR	09	6,80	195	2661058	NR	20	12,36	198
2304970	NR	04	354,05	186	2651021	NR	09	8,00	195	2661059	NR	20	1,19	199
2304971	NR	04	425,20	186	2651022	NR	09	7,52	195	2661061	NR	20	9,42	199
2304972	NR	04	28,52	187	2651023	NR	09	8,76	195	2661076	NR	20	26,05	198
2304974	NR	04	44,33	187	2651028	NR	09	15,28	195	2661084	NR	20	2,68	197
23322003	NR	17	139,46	38	2651031	NR	09	8,76	195	2661086	NR	20	6,42	206
23537003	NR	17	199,81	38	2651033	NR	09	26,56	196	2661087	NR	23	1,08	206
2394970	NR	04	496,25	186	2651034	NR	24	9,60	220	2661088	NR	23	0,96	206
2394971	NR	04	567,39	186	2651035	NR	24	9,60	220	2661089	NR	23	0,96	206
2401001	NR	01	10,36	240	2651036	NR	20	3,34	197	2661090	NR	23	0,96	206
2401004	NR	01	17,89	240	2651037	NR	20	3,34	197	2661091	NR	23	8,40	206
2401101	NR	01	29,17	239	2651039	NR	09	11,52	196	2661092	NR	20	6,60	206
2401201	NR	02	14,31	205	2651042	NR	20	6,73	197	2661093	NR	20	3,21	206
2401202	NR	02	35,70	205-239	2651044	NR	23	6,78	197	2661094	NR	20	36,61	198
2401301	NR	02	12,95	205	2651045	NR	23	6,78	197	2661095	NR	20	11,09	199
2401304	NR	02	7,92	206	2651046	NR	14	1,20	219	2661097	NR	20	29,57	192-199
2401305	NR	02	24,62	206	2651047	NR	14	1,20	219	2661099	NR	20	22,84	188-199
2402401	NR	01	31,05	188	2651050	NR	24	16,40	221	2661100	NR	20	2,68	197
2403001	NR	01	38,94	187	2651051	NR	24	16,40	221	2661103	NR	20	5,54	197
2403101	NR	01	28,05	188	2651052	NR	24	16,40	221	2661104	NR	20	6,12	199
2403401	NR	01	59,53	188	2651053	NR	24	40,96	221	2661106	NR	20	14,30	199
2403402	NR	01	99,92	188	2651054	NR	24	42,80	221	2670001	NR	06	20,48	72
2501001	NR	20	8,05	197	2651057	NR	24	5,60	221	2670002	NR	06	21,64	72
2502001	NR	20	5,59	198	2651058	NR	24	10,24	221	2670003	NR	06	22,46	72
2502003	NR	20	7,66	197	2651059	NR	24	16,40	221	2670011	NR	06	21,64	72
2502101	NR	20	6,73	197	2651060	NR	24	16,40	221	2670012	NR	06	24,19	72
2601006	NR	05	44,54	182	2651061	NR	24	16,40	221	2670020	NR	06	19,66	72

INDICE PER CODICE ARTICOLO

codice	UM	cat.	euro	pag.	codice	UM	cat.	euro	pag.	codice	UM	cat.	euro	pag.
2670021	NR	06	20,48	72	2735060	NR	06	2,02	302	2750451	NR	09	8,08	74
2670022	NR	06	21,64	72	2735061	NR	06	2,23	302	2750452	NR	09	9,04	74
2670023	NR	06	22,46	72	2735062	NR	06	2,45	302	2750501	NR	09	9,80	216
2670031	NR	06	17,17	72	2735063	NR	06	3,35	302	2750502	NR	09	7,16	216
2730203	NR	06	15,95	200	2735069	NR	06	3,35	302	2750510	NR	09	17,00	216
2730213	NR	06	13,00	200	2735070	NR	06	4,00	302	2750531	NR	09	7,68	216
2730214	NR	06	14,29	200	2735071	NR	06	4,64	302	2750532	NR	09	10,60	216
2730216	NR	06	12,24	200	2735091	NR	06	2,66	302	2750533	NR	09	18,52	216
2730217	NR	06	17,06	200	2735092	NR	06	4,46	302	2750540	NR	09	18,52	216
2730223	NR	06	14,83	201	2735111	NR	06	2,88	302	2750541	NR	09	7,68	216
2730225	NR	06	15,59	201	2735112	NR	06	4,00	302	2750601	NR	20	2,73	218
2730251	NR	06	25,67	204	2735132	NR	06	1,76	302	2750602	NR	20	2,73	218
2730252	NR	06	33,05	204	2735133	NR	06	2,45	302	2750603	NR	20	2,73	218
2730261	NR	06	12,24	201	2735141	NR	06	1,76	303	2750620	NR	20	1,58	218
2730281	NR	06	10,01	201	2735142	NR	06	2,02	303	2750623	NR	20	11,44	218
2730282	NR	06	11,12	201	2735143	NR	06	3,56	303	2750624	NR	20	2,64	218
2730283	NR	06	9,07	201	2735181	NR	06	1,76	303	2750625	NR	20	3,17	218
2731101	NR	06	6,52	202	2735182	NR	06	2,02	303	2750630	NR	23	1,68	282
2731102	NR	06	8,57	202	2735183	NR	06	3,35	303	2750635	NR	23	1,38	282
2731103	NR	06	9,79	202	2737216	NR	06	57,74	200	2750640	NR	20	2,38	218
2731104	NR	06	6,52	118	2738216	NR	06	57,74	200	2750641	NR	20	2,38	218
2731105	NR	06	5,72	202	2739216	NR	06	57,74	200	2750660	NR	20	2,90	199
2731106	NR	06	8,57	202	2750101	NR	09	60,48	216	2750831	NR	09	5,52	195
2731121	NR	06	11,02	118	2750102	NR	09	75,60	216	2750832	NR	09	6,12	195
2732001	NR	06	10,69	204	2750223	NR	06	2,45	302	2750833	NR	09	6,40	195
2732003	NR	06	14,11	204	2750224	NR	06	2,66	302	2750834	NR	09	6,40	195
2732004	NR	06	11,56	204	2750225	NR	06	2,66	302	2750835	NR	09	6,92	195
2732005	NR	06	10,80	204	2750226	NR	06	3,56	302	2750836	NR	09	7,36	195
2732006	NR	06	20,34	204	2750227	NR	06	3,56	302	2750838	NR	09	22,00	195
2732008	NR	06	14,11	204	2750240	NR	06	3,35	217-303	2750839	NR	09	25,00	195
2733000	NR	06	9,29	171-203	2750241	NR	06	4,00	217-303	2750841	NR	09	11,04	195
2733001	NR	06	11,34	171-203	2750242	NR	06	4,64	217-303	2750842	NR	09	11,80	195
2733002	NR	06	10,94	171-203	2750244	NR	06	3,35	217-303	2750843	NR	09	13,24	195
2733003	NR	06	13,39	171-203	2750245	NR	06	4,00	217-303	2750844	NR	09	12,80	195
2733004	NR	06	13,61	171-203	2750246	NR	06	4,64	217-303	2750871	NR	09	14,96	195
2733005	NR	06	19,98	171-203	2750247	NR	06	4,64	217-303	2750872	NR	09	15,76	195
2733010	NR	06	52,38	203-253	2750251	NR	06	4,86	217-303	2750881	NR	09	9,76	195
2735001	NR	06	6,23	302	2750252	NR	06	4,86	217-303	2750901	NR	20	3,96	219
2735002	NR	06	6,44	302	2750263	NR	06	4,21	217-303	2750902	NR	20	7,88	219
2735011	NR	06	5,11	302	2750264	NR	06	4,00	217-303	2750903	NR	20	15,22	218
2735012	NR	06	5,76	302	2750266	NR	06	4,00	217-303	2750904	NR	20	6,25	219
2735021	NR	06	5,33	302	2750301	NR	06	4,86	217-303	2750905	NR	24	1,44	219
2735022	NR	06	5,76	302	2750311	NR	06	3,56	217-303	2750906	NR	24	1,44	219
2735031	NR	06	3,13	217-303	2750313	NR	06	4,46	217-303	2750907	NR	24	1,52	219
2735041	NR	06	4,46	217-303	2750314	NR	06	4,46	217-303	2750908	NR	20	25,43	219
2735051	NR	06	2,88	302	2750315	NR	06	4,86	217-303	2751001	NR	09	2,60	73
2735052	NR	06	3,56	302	2750316	NR	06	4,46	217-303	2751002	NR	09	2,60	73
2735053	NR	06	4,00	302	2750321	NR	06	7,31	217-303	2751017	NR	09	6,32	73
2735054	NR	06	5,11	302	2750400	NR	09	2,48	74	2751020	NR	09	3,68	73
2735055	NR	06	6,23	302	2750401	NR	09	4,68	75	2751021	NR	09	3,68	73
2735056	NR	06	7,31	302	2750410	NR	09	3,20	75	2751022	NR	09	6,68	73
2735057	NR	06	8,89	302	2750411	NR	09	3,48	75	2751030	NR	09	1,80	73
2735059	NR	06	15,08	302	2750450	NR	09	8,08	74	2751031	NR	09	1,80	73

INDICE PER CODICE ARTICOLO

codice	UM	cat.	euro	pag.	codice	UM	cat.	euro	pag.	codice	UM	cat.	euro	pag.
2751032	NR	09	4,00	73	2810406	NR	06	6,30	208	2862103	NR	21	10,26	209
2751060	NR	09	8,80	74	2810407	NR	06	6,70	208	2862104	NR	21	11,07	209
2751061	NR	09	6,44	74	2810408	NR	06	9,00	208	2862106	NR	21	12,66	209
2751090	NR	09	13,40	75	2810409	NR	06	8,24	208	2862107	NR	21	14,17	209
2751121	NR	06	11,16	217-303	2811101	NR	06	4,97	208	2862201	NR	21	14,87	209
2751122	NR	06	10,94	217-303	2811102	NR	06	5,04	208	2862202	NR	21	15,76	209
2751123	NR	06	13,50	217-303	2811103	NR	06	5,22	208	2862203	NR	21	17,34	209
2751200	NR	09	6,40	73	2811104	NR	06	5,40	208	2862204	NR	21	18,54	209
2751201	NR	09	6,40	74	2811105	NR	06	5,54	208	2862206	NR	21	21,01	209
2751202	NR	09	6,40	74	2811106	NR	06	5,94	208	2862207	NR	21	23,42	209
2751204	NR	09	9,72	74	2811201	NR	06	5,08	208	2862301	NR	21	20,69	209
2751302	NR	09	1,40	75	2811202	NR	06	5,26	208	2862302	NR	21	22,28	209
2751303	NR	09	1,40	75	2811203	NR	06	5,54	208	2862303	NR	21	23,86	209
2751304	NR	09	1,40	75	2811204	NR	06	5,65	208	2862304	NR	21	25,44	209
2751305	NR	09	19,52	75	2811205	NR	06	5,76	208	2862306	NR	21	28,48	209
2751307	NR	09	15,40	75	2811301	NR	06	5,40	208	2862307	NR	21	31,64	209
2751308	NR	09	1,40	75	2811302	NR	06	5,58	208	2862401	NR	21	42,66	209
27597003	NR	11	37,50	113	2811303	NR	06	5,80	208	2862402	NR	21	45,37	209
27598003	NR	11	88,36	103	2811304	NR	06	5,51	208	2862403	NR	21	48,10	209
27794003	NR	11	101,70	103	2811305	NR	06	6,05	208	2862404	NR	21	50,82	209
2801102	NR	06	4,68	207	2811306	NR	06	6,48	208	2862406	NR	21	56,26	209
2801103	NR	06	4,82	207	2811309	NR	06	8,42	208	2862407	NR	21	61,89	209
2801104	NR	06	5,04	207	2812101	NR	06	5,54	208	2862502	NR	21	61,83	209
2804201	NR	06	8,53	207	2812102	NR	06	5,69	208	2862503	NR	21	65,75	209
2804202	NR	06	7,16	207	2812103	NR	06	5,90	208	2862504	NR	21	69,68	209
2804203	NR	06	7,27	207	2812104	NR	06	6,05	208	2862602	NR	21	101,06	209
2804204	NR	06	7,49	207	2812105	NR	06	6,19	208	2862603	NR	21	106,07	209
2804205	NR	06	9,14	207	2812106	NR	06	6,59	208	2862701	NR	06	17,42	205-207
2804503	NR	06	7,74	207	2812302	NR	06	6,26	208	2862702	NR	06	16,99	205-207
2810101	NR	06	4,64	208	2812303	NR	06	6,44	208	2862703	NR	06	18,97	205-207
2810102	NR	06	4,79	208	2812305	NR	06	6,73	208	2862914	NR	06	22,05	205-209
2810103	NR	06	4,97	208	2812401	NR	06	6,37	208	2862915	NR	06	25,71	205-209
2810104	NR	06	5,15	208	2812402	NR	06	6,66	208	2870003	NR	06	4,18	207
2810105	NR	06	5,18	208	2812403	NR	06	6,73	208	2870004	NR	06	4,46	207
2810106	NR	06	5,65	208	2812404	NR	06	7,02	208	2870005	NR	06	4,46	207
2810107	NR	06	6,01	208	2812405	NR	06	7,13	208	2870006	NR	06	4,86	207
2810109	NR	06	7,56	208	2812406	NR	06	7,49	208	2870011	NR	06	4,36	207
2810201	NR	06	4,79	208	2812409	NR	06	9,47	208	2870012	NR	06	4,73	207
2810202	NR	06	4,97	208	2814202	NR	06	7,09	208	2870013	NR	06	4,84	207
2810203	NR	06	5,15	208	2814203	NR	06	7,38	208	2872002	NR	06	7,63	207
2810204	NR	06	5,36	208	2814204	NR	06	8,96	208	2873004	NR	06	6,62	207
2810205	NR	06	5,54	208	2814502	NR	06	8,21	209	2873005	NR	06	6,73	207
2810206	NR	06	5,90	208	2814503	NR	06	8,42	209	2880001	NR	09	5,01	205
2810301	NR	06	4,86	208	28151002	NR	11	24,97	122	2880002	NR	09	6,09	205
2810302	NR	06	5,04	208	2815201	NR	06	7,74	209	2880003	NR	09	7,17	205
2810303	NR	06	5,22	208	2815202	NR	06	7,92	209	2880005	NR	09	9,35	205
2810304	NR	06	5,47	208	2815203	NR	06	8,14	209	2881001	NR	09	5,01	205
2810305	NR	06	5,58	208	2820102	NR	06	9,29	209	2881002	NR	09	6,09	205
2810401	NR	06	5,22	208	2820103	NR	06	9,72	209	2881003	NR	09	7,17	205
2810402	NR	06	5,47	208	2820105	NR	06	10,66	209	2881004	NR	09	8,46	205
2810403	NR	06	5,58	208	28261003	NR	11	52,75	113	2882001	NR	09	3,59	205
2810404	NR	06	5,80	208	2862101	NR	21	8,67	209	2882002	NR	09	3,72	205
2810405	NR	06	5,87	208	2862102	NR	21	9,49	209	2882003	NR	09	4,20	205

INDICE PER CODICE ARTICOLO

codice	UM	cat.	euro	pag.	codice	UM	cat.	euro	pag.	codice	UM	cat.	euro	pag.
2882004	NR	09	4,76	205	3001916	NR	03	378,66	22	3005029	NR	05	113,98	44
2882005	NR	09	5,24	205	3001917	NR	03	416,52	23	3005050	NR	03	171,99	52
2883001	NR	20	7,92	205	3001918	NR	03	234,42	23	3005051	NR	03	171,99	52
2900000	NR	13	176,53	289	3001926	NR	03	1.607,04	23	3005101	NR	03	53,76	22-27-46
2900001	NR	17	206,41	289	3001927	NR	03	261,15	20	3005102	NR	03	108,60	22-27-46
2900002	NR	17	291,41	289	3002013	NR	03	139,68	59	3005751	NR	03	219,18	52
2900003	NR	17	364,29	289	3002014	NR	03	104,16	59	3005950	NR	03	219,18	52
2900004	NR	17	619,29	289	3003010	NR	03	80,67	34	3006001	NR	03	167,31	36
29119000	NR	10	877,83	84	3003011	NR	03	86,59	34	3007001	NR	05	160,48	40
29124000	NR	10	877,83	84	3003012	NR	03	82,53	34	3007002	NR	05	156,40	40
3001000	NR	11	167,85	48-52	3003013	NR	03	126,38	35	3007003	NR	05	260,83	40
3001005	NR	03	146,03	85	3003014	NR	03	55,76	35	3007004	NR	05	260,83	41
3001010	NR	03	185,55	20	3003015	NR	03	78,06	35	3007005	NR	05	213,99	41
3001011	NR	03	272,64	20	3003016	NR	03	115,23	35	3007006	NR	05	160,48	41
3001012	NR	03	184,02	21	3003019	NR	03	91,82	34-59	3007007	NR	05	143,15	41
3001013	NR	03	215,85	21	3003020	NR	03	86,59	34	3007008	NR	05	260,83	42
3001014	NR	03	71,91	21	3004001	NR	03	87,52	36	3007009	NR	05	222,71	42
3001015	NR	03	132,57	21	3004002	NR	03	87,52	36	3007018	NR	05	121,73	54
3001016	NR	03	280,11	22	3004003	NR	03	76,56	37	3007019	NR	05	119,08	57
3001017	NR	03	291,60	23	3004004	NR	03	85,87	37	3007024	NR	05	211,55	40
3001018	NR	03	181,77	23	3004005	NR	03	114,84	37	3008001	NR	03	111,18	29
3001019	NR	03	23,61	22	3004006	NR	03	78,22	56	3008002	NR	03	225,54	30
3001020	NR	03	30,63	22	3004008	NR	03	94,68	57	3008003	NR	03	111,18	30
3001026	NR	03	1.347,84	23	3004009	NR	03	102,10	36-59	3008004	NR	03	79,41	31
3001027	NR	03	200,88	20	3004010	NR	03	94,68	56	3008005	NR	03	144,60	31
3001710	NR	03	242,37	20	3004012	NR	03	182,49	37	3008006	NR	03	190,65	30
3001711	NR	03	355,41	20	3004101	NR	03	391,02	18	3008007	NR	03	171,33	31
3001712	NR	03	242,37	21	3004103	NR	03	492,49	18	3008009	NR	03	170,40	29
3001713	NR	03	279,78	21	3004105	NR	03	579,08	18	3008010	NR	03	170,40	29
3001714	NR	03	92,64	21	3004107	NR	03	276,01	18	3008011	NR	03	111,18	29
3001715	NR	03	172,05	21	3004108	NR	03	282,78	18	3008012	NR	03	111,18	30
3001716	NR	03	378,09	22	3004109	NR	03	391,02	19	3008032	NR	03	159,51	54
3001717	NR	03	415,89	23	3004111	NR	03	159,65	19	3008033	NR	03	159,51	55
3001718	NR	03	234,42	23	3004112	NR	03	211,07	19	3008034	NR	03	290,04	53
3001726	NR	03	1.607,04	23	3004113	NR	03	276,01	19	3008801	NR	03	86,64	32
3001727	NR	03	261,15	20	3004114	NR	03	377,49	19	3008802	NR	03	115,98	32-59
3001810	NR	03	280,20	20	3005001	NR	05	110,04	43	3008803	NR	03	86,64	32
3001811	NR	03	408,33	20	3005002	NR	05	110,04	43	3008804	NR	03	67,17	33
3001812	NR	03	280,20	21	3005003	NR	05	113,98	44	3008805	NR	03	124,86	32
3001813	NR	03	321,39	21	3005004	NR	05	32,73	44	3008806	NR	03	97,17	33
3001814	NR	03	100,53	21	3005005	NR	05	38,15	45	3008807	NR	03	127,89	33
3001815	NR	03	196,95	21	3005008	NR	05	132,68	43	3008808	NR	03	92,28	56
3001816	NR	03	442,32	22	3005009	NR	05	87,47	43	3008809	NR	03	122,07	57
3001817	NR	03	472,59	23	3005010	NR	05	77,93	57	3008810	NR	03	108,42	53
3001818	NR	03	272,22	23	3005012	NR	05	71,57	54	3008850	NR	03	97,35	56
3001826	NR	03	1.927,80	23	3005014	NR	05	40,85	58	3008855	NR	11	252,13	49-52
3001827	NR	03	301,32	20	3005016	NR	05	39,61	44	3008901	NR	02	65,89	67
3001910	NR	03	242,37	20	3005020	NR	05	106,03	43	3008903	NR	02	76,02	66
3001911	NR	03	355,95	20	3005021	NR	05	39,74	44	3008904	NR	02	65,89	61
3001912	NR	03	242,37	21	3005025	NR	05	74,68	58	3008905	NR	02	65,89	61
3001913	NR	03	280,20	21	3005026	NR	05	55,68	45	3008906	NR	02	65,89	61
3001914	NR	03	92,79	21	3005027	NR	05	100,54	58	3008908	NR	02	63,85	61
3001915	NR	03	172,29	21	3005028	NR	03	75,63	58-253	3008910	NR	02	65,89	68

INDICE PER CODICE ARTICOLO

codice	UM	cat.	euro	pag.	codice	UM	cat.	euro	pag.	codice	UM	cat.	euro	pag.
3008911	NR	02	88,03	69	3021910	NR	03	227,22	24	3101098	NR	09	12,72	60
3008913	NR	02	76,02	66	3021911	NR	03	337,02	24	3101099	NR	09	12,72	60
3008915	NR	02	65,89	61	3021912	NR	03	227,22	25	3101100	NR	09	12,72	60
3008918	NR	02	96,29	68	3021913	NR	03	196,95	25	3101101	NR	09	18,32	60
3008919	NR	02	72,62	68	3021914	NR	03	219,27	25	3101102	NR	06	27,14	66
3008920	NR	02	69,26	62	3021915	NR	03	113,64	26	3101103	NR	06	30,24	66
3008921	NR	02	65,89	62	3021916	NR	03	196,95	26	3101104	NR	06	30,42	66
3008922	NR	02	57,43	67	3021917	NR	03	317,58	26	3101106	NR	06	42,73	66
3009015	NR	03	307,56	53	3021918	NR	03	385,62	27	3101109	NR	02	101,05	70
3012002	NR	11	279,65	83	3021919	NR	03	374,52	28	3101110	NR	02	101,05	70
3012003	NR	11	365,34	83	3021920	NR	03	226,86	28	3101111	NR	02	23,46	69
3012902	NR	11	421,08	83	3021923	NR	03	169,41	55	3101112	NR	02	46,55	62
3012903	NR	11	512,31	83	3021924	NR	03	193,56	55	3101113	NR	02	46,55	62
3013002	NR	11	439,93	83	3021925	NR	03	169,41	53	3101114	NR	02	32,47	67
3013003	NR	11	439,93	83	3021926	NR	03	283,08	24	3101115	NR	02	32,47	67
3013902	NR	11	638,64	83	3021927	NR	03	283,08	25	3101116	NR	02	37,54	67
3013903	NR	11	638,64	83	3021931	NR	03	1.771,32	28	3101117	NR	06	62,85	65
3021010	NR	03	170,43	24	30581000	NR	13	545,54	51	3101120	NR	09	17,04	74
3021011	NR	03	261,30	24	3101001	NR	02	27,34	66	3101122	NR	09	27,50	65
3021012	NR	03	170,43	25	3101004	NR	02	17,44	67	3101123	NR	02	68,44	68
3021013	NR	03	151,50	25	3101005	NR	09	31,77	61	3101124	NR	02	150,59	68
3021014	NR	03	182,40	25	3101006	NR	09	28,20	61	3101138	NR	02	64,02	70
3021015	NR	03	79,53	26	3101012	NR	20	9,33	198	3101147	NR	09	64,68	61
3021016	NR	03	151,50	26	3101014	NR	02	8,00	69	3101150	NR	02	21,15	62
3021017	NR	03	246,15	26	3101015	NR	02	8,00	69	3101157	NR	06	41,33	66
3021018	NR	03	295,38	27	3101018	NR	02	30,26	69	3101230	NR	02	44,23	65
3021019	NR	03	302,55	28	3101020	NR	02	80,93	68	31367001	NR	11	165,01	54
3021020	NR	03	179,88	28	3101031	NR	09	11,40	63	3203033	NR	05	69,22	165
3021021	NR	03	41,16	27	3101032	NR	09	16,37	63	3203034	NR	05	69,22	165
3021022	NR	03	49,41	27	3101038	NR	02	41,40	70	3203051	NR	06	24,43	164
3021023	NR	03	144,45	55	3101042	NR	09	28,20	60	3203054	NR	05	67,20	164
3021024	NR	03	158,91	55	3101054	NR	02	13,05	67	3203056	NR	13	175,50	160
3021025	NR	03	134,49	53	3101057	NR	02	27,34	67	3203057	NR	05	76,80	153
3021026	NR	03	201,93	24	3101059	NR	09	16,90	62	3203058	NR	05	67,84	153
3021027	NR	03	202,23	25	3101060	NR	09	16,90	62	3203059	NR	13	243,00	160
3021031	NR	03	1.265,22	28	3101061	NR	06	59,04	65	3203060	NR	02	58,24	160
3021810	NR	03	268,86	24	3101064	NR	02	14,59	66	3203061	NR	02	82,01	160
3021811	NR	03	386,07	24	3101065	NR	02	19,78	68	3203063	NR	02	62,97	160
3021812	NR	03	268,86	25	3101066	NR	02	50,86	70	3203067	NR	03	49,77	164
3021813	NR	03	227,22	25	3101069	NR	09	31,77	60	3203092	NR	05	38,40	165
3021814	NR	03	253,77	25	3101070	NR	02	16,01	67	32929003	NR	17	121,84	38
3021815	NR	03	136,11	26	3101072	NR	09	38,10	63	3301001	NR	01	66,30	166
3021816	NR	03	227,22	26	3101074	NR	09	16,90	60	3301012	NR	01	68,61	166
3021817	NR	03	363,54	26	3101075	NR	02	30,59	66	3301032	NR	02	42,96	166
3021818	NR	03	446,13	27	3101076	NR	09	14,87	63	3301034	NR	01	55,07	166
3021819	NR	03	431,25	28	3101077	NR	06	87,60	65	3301041	NR	02	88,77	167
3021820	NR	03	264,69	28	3101081	NR	02	19,78	68	3301080	NR	02	115,94	167
3021823	NR	03	207,21	55	3101084	NR	02	35,12	70	3302006	NR	15	28,49	169
3021824	NR	03	225,33	55	3101088	NR	06	59,04	65	3302007	NR	15	33,37	169
3021825	NR	03	199,62	53	3101089	NR	06	66,69	65	3302010	NR	06	28,51	169
3021826	NR	03	323,04	24	3101090	NR	02	61,15	70	3302013	NR	06	10,40	171
3021827	NR	03	323,04	25	3101096	NR	02	30,91	69	3302016	NR	06	53,28	169
3021831	NR	03	2.024,34	28	3101097	NR	09	29,44	60	3302017	NR	15	22,25	169

INDICE PER CODICE ARTICOLO

codice	UM	cat.	euro	pag.	codice	UM	cat.	euro	pag.	codice	UM	cat.	euro	pag.
3302101	NR	06	10,20	170	3402002	NR	03	306,97	174	3517004	NR	04	196,39	139
3302103	NR	06	16,76	170	3402003	NR	03	350,63	174	3517005	NR	04	210,06	139
3302104	NR	06	29,98	170	3402004	NR	03	371,68	174	3517006	NR	04	262,79	139
3302106	NR	06	11,72	170	3402005	NR	03	370,19	174	3517007	NR	04	368,25	139
3302107	NR	06	15,08	170	3402006	NR	03	403,29	174	3517008	NR	04	254,73	139
3302108	NR	06	13,40	170	3402007	NR	03	510,11	174	3517009	NR	04	294,97	139
3302109	NR	06	5,01	170	3402008	NR	03	526,68	174	3517010	NR	04	388,80	139
3302112	NR	06	220,18	170	3402009	NR	03	505,63	174	3517011	NR	04	196,63	139
3302114	NR	23	18,50	220	3402010	NR	03	406,30	174	3540302	NR	04	65,10	141-143-145
3302115	NR	23	18,50	220	3402011	NR	03	571,82	174	3540303	NR	04	71,01	147
3302117	NR	06	18,47	172	3402012	NR	03	406,30	174	35420BM	NR	04	343,19	146
3302119	NR	06	14,78	172	3402013	NR	03	571,82	174	35421BM	NR	04	355,34	146
3302126	NR	06	16,61	172	3403001	NR	03	242,09	175	35422BM	NR	04	376,60	146
3302128	NR	06	13,85	172	3403002	NR	03	245,15	175	35423BM	NR	04	355,34	146
3302129	NR	02	38,73	172	3403003	NR	03	271,19	175	35424BM	NR	04	422,15	146
3302201	NR	06	18,47	172	3403004	NR	03	291,11	175	35425BM	NR	04	388,74	146
3302202	NR	06	18,47	172	3403005	NR	03	312,55	175	35426BM	NR	04	388,74	146
3302203	NR	06	9,76	171	3403006	NR	03	324,81	175	35427BM	NR	04	440,38	146
3302204	NR	06	11,81	171	3403007	NR	03	438,21	175	35428BM	NR	04	543,64	146
3302205	NR	06	10,58	171	3403008	NR	03	436,67	175	35429BM	NR	04	422,15	146
3302301	NR	06	44,97	168	3403009	NR	03	419,80	175	35430BM	NR	04	443,41	146
3302302	NR	06	37,50	168	3405001	NR	03	223,71	176	35431BM	NR	04	410,00	146
3302410	NR	06	27,99	169	3405002	NR	03	225,22	176	35432BM	NR	04	431,26	146
3302411	NR	06	41,00	169	3405003	NR	03	239,03	176	35433BM	NR	04	543,64	146
33202003	NR	17	164,94	54	3405004	NR	03	249,75	176	35434BM	NR	04	561,86	146
33265003	NR	17	121,84	38	3405021	NR	03	137,89	176	35435BM	NR	04	498,08	146
33302003	NR	17	200,56	39	3405022	NR	03	160,88	176	35436BM	NR	04	519,34	146
33305003	NR	17	154,44	39	3405030	NR	03	597,54	175	35437BM	NR	04	510,23	146
3350001	NR	17	1.621,73	212	3405050	NR	03	58,48	177	35438BM	NR	04	519,34	146
3350010	NR	13	147,08	285	3405051	NR	03	30,78	177	35439BM	NR	04	607,41	146
3350011	NR	13	107,48	285	3405052	NR	03	32,32	177	35440BM	NR	04	707,64	146
3350020	NR	13	123,20	238	3405053	NR	03	60,02	177	35441BM	NR	04	552,75	146
3350021	NR	13	173,06	284	3405054	NR	03	38,48	177	35442BM	NR	04	577,04	146
3350024	NR	13	166,88	284	3405055	NR	03	61,56	177	35443BM	NR	04	622,60	146
3350028	NR	17	313,22	284	3405056	NR	03	64,64	177	35444BM	NR	04	698,53	146
3350040	NR	17	885,22	213	3405058	NR	03	64,64	177	35445BM	NR	04	586,15	146
3350050	NR	17	1.212,40	212	3407005	NR	03	170,08	176	35446BM	NR	04	607,41	146
3350060	NR	17	1.008,44	211	3407006	NR	03	173,14	176	35447BM	NR	04	731,93	146
3350070	NR	17	2.489,52	213	3407007	NR	03	186,92	176	35448BM	NR	04	713,71	146
3350080	NR	17	1.165,66	211	3407008	NR	03	203,78	176	35449BM	NR	04	619,56	146
3350090	NR	17	1.335,62	211	3407061	NR	03	205,30	175	35450BM	NR	04	640,82	146
3350100	NR	17	900,80	211	3407062	NR	03	212,96	175	35451BM	NR	04	765,34	146
3350110	NR	17	1.082,10	213	3407063	NR	03	232,88	175	35452BM	NR	04	698,53	146
3350503	NR	17	56,65	212	3407064	NR	03	254,35	175	35453BM	NR	04	786,60	146
3350610	NR	13	61,78	285	3408001	NR	03	47,92	177	35454BM	NR	04	841,27	146
3350640	NR	17	1.254,89	213	3408002	NR	03	49,92	177	35455BM	NR	04	713,71	146
3351021	NR	03	210,12	284	3408003	NR	03	51,89	177	35456BM	NR	04	829,12	146
3351023	NR	03	125,55	239	3408011	NR	03	55,89	177	35460BM	NR	04	376,60	142
3351024	NR	03	144,51	284	3408012	NR	03	57,89	177	35461BM	NR	04	388,74	142
3351026	NR	03	219,51	239	3408013	NR	03	59,89	177	35462BM	NR	04	443,41	142
33555003	NR	17	133,46	39	3517001	NR	04	178,75	139	35463BM	NR	04	422,15	142
33556003	NR	17	128,28	39	3517002	NR	04	187,71	139	35464BM	NR	04	464,67	142
3402001	NR	03	297,96	174	3517003	NR	04	214,52	139	35465BM	NR	04	443,41	142

INDICE PER CODICE ARTICOLO

codice	UM	cat.	euro	pag.	codice	UM	cat.	euro	pag.	codice	UM	cat.	euro	pag.
35466BM	NR	04	443,41	142	35527BM	NR	04	765,34	140	3569003	NR	04	113,12	151
35467BM	NR	04	519,34	142	35528BM	NR	04	862,53	140	3569004	NR	04	105,58	151
35468BM	NR	04	498,08	142	35529BM	NR	04	1.096,38	140	3569005	NR	04	105,58	151
35469BM	NR	04	476,82	142	35530BM	NR	04	1.205,72	140	3569006	NR	04	196,08	151
35470BM	NR	04	510,23	142	35531BM	NR	04	443,41	140	3569007	NR	04	135,75	151
35471BM	NR	04	607,41	142	35532BM	NR	04	498,08	140	3569008	NR	04	143,29	151
35472BM	NR	04	552,75	142	35541BM	NR	04	274,78	148	3569009	NR	04	128,21	151
35473BM	NR	04	586,15	142	35542BM	NR	04	262,76	148	3569010	NR	04	113,12	151
35474BM	NR	04	543,64	142	35543BM	NR	04	289,82	148	3569011	NR	04	113,12	151
35475BM	NR	04	564,90	142	35544BM	NR	04	328,91	148	3569012	NR	04	135,75	151
35476BM	NR	04	665,12	142	35545BM	NR	04	289,82	148	3569013	NR	04	211,16	151
35477BM	NR	04	607,41	142	35546BM	NR	04	313,88	148	3569014	NR	04	22,62	151
35478BM	NR	04	652,97	142	35547BM	NR	04	301,85	148	35701BM	NR	04	353,15	144
35479BM	NR	04	774,45	142	35548BM	NR	04	368,00	148	35702BM	NR	04	377,93	144
35480BM	NR	04	765,34	142	35549BM	NR	04	328,91	148	35703BM	NR	04	396,52	144
35481BM	NR	04	674,23	142	35550BM	NR	04	368,00	148	35704BM	NR	04	377,93	144
35482BM	NR	04	674,23	142	35551BM	NR	04	352,97	148	35705BM	NR	04	427,50	144
35483BM	NR	04	698,53	142	35552BM	NR	04	419,12	148	35706BM	NR	04	396,52	144
35484BM	NR	04	707,64	142	35553BM	NR	04	380,03	148	35707BM	NR	04	408,91	144
35485BM	NR	04	895,94	142	35554BM	NR	04	431,15	148	35708BM	NR	04	433,69	144
35486BM	NR	04	765,34	142	35555BM	NR	04	482,27	148	35709BM	NR	04	508,04	144
35487BM	NR	04	862,53	142	35556BM	NR	04	458,21	148	35710BM	NR	04	446,08	144
35488BM	NR	04	1.096,38	142	35557BM	NR	04	521,36	148	35711BM	NR	04	470,87	144
35489BM	NR	04	1.205,72	142	35558BM	NR	04	575,48	148	35712BM	NR	04	402,72	144
35490BM	NR	04	443,41	142	35559BM	NR	04	482,27	148	35713BM	NR	04	458,48	144
35491BM	NR	04	498,08	142	35560BM	NR	04	575,48	148	35714BM	NR	04	539,02	144
3550003	NR	17	1.621,72	212	35561BM	NR	04	587,51	148	35715BM	NR	04	594,78	144
35501BM	NR	04	376,60	140	35562BM	NR	04	638,63	148	35716BM	NR	04	526,63	144
35502BM	NR	04	388,74	140	35604000	NR	13	107,95	46-84	35717BM	NR	04	545,21	144
35503BM	NR	04	443,41	140	35610BM	NR	04	48,68	141-143	35718BM	NR	04	483,26	144
35504BM	NR	04	422,15	140	35611BM	NR	04	46,35	147	35719BM	NR	04	520,43	144
35505BM	NR	04	464,67	140	35615BM	NR	04	74,41	145	35720BM	NR	04	619,56	144
35506BM	NR	04	443,41	140	35616BM	NR	04	74,41	143	35721BM	NR	04	681,52	144
35507BM	NR	04	443,41	140	35617BM	NR	04	74,41	141	35722BM	NR	04	557,61	144
35508BM	NR	04	519,34	140	35618BM	NR	04	74,41	147	35723BM	NR	04	619,56	144
35509BM	NR	04	498,08	140	35619BM	NR	04	38,27	145	35724BM	NR	04	681,52	144
35510BM	NR	04	476,82	140	35650BF	NR	04	618,41	150	35725BM	NR	04	731,08	144
35511BM	NR	04	510,23	140	35650CL	NR	04	618,41	150	35726BM	NR	04	619,56	144
35512BM	NR	04	607,41	140	35650CW	NR	04	618,41	150	35727BM	NR	04	625,76	144
35513BM	NR	04	552,75	140	35650MB	NR	04	618,41	150	35728BM	NR	04	718,69	144
35514BM	NR	04	586,15	140	35650MD	NR	04	618,41	150	35729BM	NR	04	755,87	144
35515BM	NR	04	543,64	140	35650MG	NR	04	618,41	150	35730BM	NR	04	594,78	144
35516BM	NR	04	564,90	140	35650VS	NR	04	618,41	150	35731BM	NR	04	656,74	144
35517BM	NR	04	665,12	140	35651BF	NR	04	791,86	150	35732BM	NR	04	749,67	144
35518BM	NR	04	607,41	140	35651CL	NR	04	791,86	150	35733BM	NR	04	656,74	144
35519BM	NR	04	652,97	140	35651CW	NR	04	791,86	150	35734BM	NR	04	762,06	144
35520BM	NR	04	774,45	140	35651MB	NR	04	791,86	150	35735BM	NR	04	817,82	144
35521BM	NR	04	765,34	140	35651MD	NR	04	791,86	150	35736BM	NR	04	805,43	144
35522BM	NR	04	674,23	140	35651MG	NR	04	791,86	150	35737BM	NR	04	904,56	144
35523BM	NR	04	674,23	140	35651VS	NR	04	791,86	150	35738BM	NR	04	396,52	145
35524BM	NR	04	698,53	140	3569000	NR	04	120,66	151	35739BM	NR	04	470,87	145
35525BM	NR	04	707,64	140	3569001	NR	04	113,12	151	3602062	NR	04	326,93	137
35526BM	NR	04	895,94	140	3569002	NR	04	113,12	151	3602070	NR	03	153,60	138

INDICE PER CODICE ARTICOLO

codice	UM	cat.	euro	pag.	codice	UM	cat.	euro	pag.	codice	UM	cat.	euro	pag.
3602080	NR	04	396,27	137	3702374	NR	04	406,60	129	4009008	NR	03	229,71	161
3602081	NR	04	396,27	137	3702377	NR	04	469,15	129	4009011	NR	17	261,33	156
3602082	NR	04	381,58	137	3702378	NR	04	469,15	129	4009016	NR	02	77,25	163
3602083	NR	04	346,98	137	3702379	NR	04	469,15	129	4009017	NR	03	124,77	162
3602084	NR	04	403,59	137	3702380	NR	04	469,15	130	4009018	NR	03	40,89	162
3602085	NR	04	383,69	137	3702381	NR	04	469,15	130	4009019	NR	03	208,65	162
3603080	NR	04	594,39	137	3702382	NR	04	106,45	130	4009023	NR	03	276,06	161
3603081	NR	04	594,39	137	3702383	NR	04	163,53	130	4009024	NR	03	227,76	161
3603082	NR	04	572,38	137	3702385	NR	04	163,53	130	4009026	NR	03	72,36	162
3603083	NR	04	519,96	137	3702390	NR	09	111,08	135	4009027	NR	03	156,24	161
3603084	NR	04	604,87	137	3702391	NR	09	14,80	136	4009029	NR	03	61,86	163
3603085	NR	04	575,52	137	3703354	NR	04	532,39	131	4009031	NR	03	61,86	163
36451000	NR	10	373,97	45	3703355	NR	04	532,39	131	4009032	NR	03	69,09	163
3701601	NR	03	201,63	138	3703357	NR	04	524,86	132	40404001	NR	13	133,38	47-51-71
3701602	NR	03	171,48	138	3703358	NR	04	524,86	132	40430001	NR	13	263,95	47-51-71
3701603	NR	03	160,80	138	3703360	NR	04	307,64	132	4101000	NR	03	31,92	158
3701703	NR	03	138,90	138	3703371	NR	04	656,83	128	4101001	NR	03	37,95	158
3701704	NR	03	194,40	138	3703372	NR	04	609,93	128	4101002	NR	03	46,29	158
3702305	NR	04	130,39	133	3703373	NR	04	609,93	128	4101003	NR	03	46,29	158
3702321	NR	04	99,88	134	3703374	NR	04	609,93	129	4101004	NR	03	50,37	158
3702325	NR	09	22,20	136	3703378	NR	04	703,76	129	4101005	NR	03	60,60	158
3702332	NR	04	141,73	133	3703379	NR	04	703,76	129	4101006	NR	03	68,58	158
3702333	NR	09	11,84	136	3703383	NR	04	294,13	130	4101007	NR	03	76,56	158
3702334	NR	04	160,70	134	3703385	NR	04	294,13	130	4102001	NR	03	52,65	158
3702336	NR	04	264,55	134	37054SH0	NR	10	85,65	168	4104001	NR	10	128,10	158
3702337	NR	04	264,55	134	37092000	NR	10	70,67	172	4104002	NR	10	137,65	158
3702338	NR	04	259,81	134	37103SH0	NR	10	16,13	171	4104004	NR	03	357,33	158
3702339	NR	04	259,81	134	37859SH0	NR	10	81,98	168	4104005	NR	03	23,10	158
3702341	NR	04	137,95	133	38729000	NR	17	293,02	168	42253000	NR	10	122,02	172
3702342	NR	04	134,17	133	38732000	NR	11	111,77	168	42310000	NR	10	10,05	173
3702343	NR	04	120,00	133	387325H0	NR	11	96,25	168	42320000	NR	10	69,89	172
3702344	NR	04	120,00	133	38863000	NR	17	182,31	167	42961000	NR	10	52,14	173
3702345	NR	09	50,36	135	4001052	NR	26	228,44	152	42962000	NR	10	27,50	173
3702346	NR	09	41,48	135	4001053	NR	26	228,44	152	4301001	NR	11	80,71	159
3702347	NR	09	50,36	135	4001054	NR	26	228,44	152	4301002	NR	11	84,71	159
3702348	NR	09	11,84	136	4001059	NR	17	117,39	153	4301003	NR	11	91,38	159
3702349	NR	09	165,88	135	4001061	NR	26	304,06	152	4301004	NR	11	96,05	159
3702350	NR	04	550,65	131	4001062	NR	26	304,06	152	4301005	NR	11	126,06	159
3702351	NR	04	477,52	131	4001063	NR	26	304,06	152	4301006	NR	11	97,38	159
3702352	NR	04	376,43	131	4001064	NR	17	141,13	153	4301007	NR	11	260,13	159
3702353	NR	04	376,43	131	4001065	NR	17	64,17	153	4301008	NR	11	280,81	159
3702354	NR	04	354,92	131	4001066	NR	10	54,74	156	43486000	NR	10	93,02	173
3702355	NR	04	354,92	131	4001067	NR	10	379,32	156	43544000	NR	10	23,38	173
3702356	NR	04	354,92	132	4001072	NR	26	155,53	154	43546000	NR	10	7,28	173
3702357	NR	04	349,56	132	4001073	NR	26	155,53	154	43733000	NR	10	7,45	173
3702358	NR	04	349,56	132	4001074	NR	26	169,28	154	43917000	NR	10	37,46	173
3702359	NR	04	111,35	132	4001075	NR	26	169,28	154	43966000	NR	10	87,58	173
3702360	NR	04	171,03	132	4001076	NR	17	117,39	154	43985000	NR	10	18,42	173
3702361	NR	04	171,03	132	4002003	NR	10	44,44	155	43991000	NR	10	72,55	172
3702370	NR	04	377,43	128	4002004	NR	13	336,69	155	43992000	NR	10	140,73	173
3702371	NR	04	437,88	128	4002005	NR	13	367,25	155	4501001	NR	03	28,56	340
3702372	NR	04	406,60	128	4003002	NR	10	39,17	156	4501002	NR	03	29,91	340
3702373	NR	04	406,60	128	4009007	NR	03	179,25	161	4501003	NR	03	35,28	340

INDICE PER CODICE ARTICOLO

codice	UM	cat.	euro	pag.	codice	UM	cat.	euro	pag.	codice	UM	cat.	euro	pag.
4501004	NR	03	47,70	340	4602003	NR	01	12,31	344	4654021	MT	22	14,24	347
4501005	NR	03	55,11	340	4602005	NR	01	14,03	344	4654022	MT	22	14,99	347
4501006	NR	03	78,96	340	4602007	NR	01	16,57	344	4655003	MT	22	11,59	347
4501007	NR	03	170,01	340	4602009	NR	01	14,26	344	4655004	MT	22	13,02	347
4501008	NR	03	241,92	340	4602011	NR	01	16,34	344	4655005	MT	22	13,78	347
4501009	NR	03	420,00	340	4602013	NR	01	20,66	344	4655006	MT	22	15,16	347
45346000	NR	10	52,39	63	4602015	NR	01	23,13	344	4655007	MT	22	16,46	347
45869000	NR	10	54,21	63	4602017	NR	01	19,67	344	4655009	MT	22	17,81	347
4600011	NR	02	12,00	344	4602019	NR	01	21,55	344	4655010	MT	22	19,19	347
4600013	NR	02	13,74	344	4602021	NR	01	28,15	344	4655011	MT	22	20,54	347
4600015	NR	02	15,16	344	4602023	NR	01	32,41	344	4655012	MT	22	21,84	347
4600017	NR	02	16,59	344	4602025	NR	01	22,31	344	4655014	MT	22	24,78	347
4600019	NR	02	18,33	344	4602031	NR	01	27,89	344	4655015	MT	22	27,38	347
4600021	NR	02	15,20	344	4602043	NR	01	14,78	344	46580000	NR	10	87,33	62
4600023	NR	02	17,44	344	4602044	NR	01	16,34	344	4662003	NR	02	4,08	347
4600025	NR	02	20,23	344	4602045	NR	01	20,66	344	4662004	NR	02	4,83	347
4600027	NR	02	22,92	344	46048000	NR	10	75,18	62	4662006	NR	02	11,36	347
4600029	NR	02	27,37	344	4606010	NR	01	74,22	346	4663001	NR	02	1,26	347
4600033	NR	02	22,51	344	4606011	NR	01	148,40	346	4663003	NR	02	1,33	347
4600035	NR	02	26,86	344	4606015	NR	01	176,06	346	4663005	NR	02	1,39	347
4600037	NR	02	31,25	344	4606100	NR	01	50,92	346	4663006	NR	02	1,39	347
4600039	NR	02	37,20	344	4606101	NR	01	101,84	346	4701101	NR	07	31,71	343
4600042	NR	02	17,44	344	4606104	NR	01	63,29	346	4701102	NR	07	31,71	343
4600044	NR	02	22,92	344	4606105	NR	01	126,59	346	4701103	NR	07	35,46	343
4601003	NR	01	10,76	344	4606301	NR	01	13,43	346	4701104	NR	07	35,46	343
4601009	NR	01	8,84	344	4606302	NR	01	22,01	346	4701105	NR	07	39,06	343
4601011	NR	01	10,20	344	4606303	NR	01	13,43	346	4701106	NR	07	39,06	343
4601013	NR	01	12,74	344	4606304	NR	01	22,01	346	4701109	NR	07	46,83	343
4601014	NR	01	12,74	344	4606310	NR	01	44,62	346	4701110	NR	07	46,83	343
4601015	NR	01	14,36	344	4606311	NR	01	70,32	346	4701111	NR	07	51,10	343
4601016	NR	01	14,36	344	4606313	NR	01	62,54	346	4701112	NR	07	51,10	343
4601017	NR	01	12,01	344	4606401	NR	01	389,33	346	4701137	NR	01	112,63	343
4601019	NR	01	13,83	344	4606409	NR	01	307,69	346	4701138	NR	01	103,22	343
4601020	NR	01	13,83	344	4606410	NR	01	48,71	346	4701139	NR	01	93,85	343
4601021	NR	01	18,88	344	4606411	NR	01	48,71	346	4701140	NR	01	84,45	343
4601022	NR	01	18,88	344	4606412	NR	01	48,71	346	4701211	NR	21	19,49	343
4601023	NR	01	21,09	344	46092000	NR	10	110,54	69	4701212	NR	21	19,49	343
4601025	NR	01	16,14	344	46374000	NR	10	76,97	62	4701215	NR	21	24,05	343
4601027	NR	01	18,15	344	4654002	MT	22	9,53	347	4701216	NR	21	24,05	343
4601029	NR	01	24,65	344	4654003	MT	22	9,70	347	4701219	NR	21	28,50	343
4601031	NR	01	29,01	344	4654004	MT	22	9,95	347	4701220	NR	21	28,50	343
4601035	NR	01	51,12	344	4654005	MT	22	10,29	347	4701221	NR	21	33,63	343
4601037	NR	01	58,71	344	4654006	MT	22	11,42	347	4701222	NR	21	33,63	343
4601039	NR	01	63,26	344	4654007	MT	22	12,43	347	4702001	NR	01	12,77	343
4601041	NR	01	60,85	344	4654008	MT	22	12,85	347	4702003	NR	01	14,52	343
4601043	NR	01	69,96	344	4654009	MT	22	13,86	347	4702005	NR	01	15,91	343
4601045	NR	01	75,44	344	4654010	MT	22	14,70	347	4702007	NR	01	17,26	343
4601047	NR	01	84,12	344	4654011	MT	22	15,33	347	4702009	NR	01	18,98	343
4601049	NR	01	95,07	344	4654012	MT	22	17,18	347	4702011	NR	01	15,91	343
4601051	NR	01	101,67	344	4654014	MT	22	20,33	347	4702013	NR	01	18,32	343
4601054	NR	01	13,83	344	4654015	MT	22	22,68	347	4702015	NR	01	21,05	343
4601055	NR	01	18,88	344	4654018	MT	22	31,04	347	4702017	NR	01	23,83	343
4602001	NR	01	10,92	344	4654020	MT	22	40,45	347	4702019	NR	01	28,31	343

INDICE PER CODICE ARTICOLO

codice	UM	cat.	euro	pag.	codice	UM	cat.	euro	pag.	codice	UM	cat.	euro	pag.
4702023	NR	01	23,46	343	4808005	NR	02	44,37	340	4821201	NR	02	20,94	341
4702027	NR	01	32,11	343	4808006	NR	02	69,60	340	4821202	NR	02	21,86	341
4702031	NR	01	15,91	343	4808007	NR	02	100,54	340	4821203	NR	02	30,74	341
4702032	NR	01	18,32	343	4809001	NR	02	21,01	340	4821204	NR	02	32,74	341
4702034	NR	01	23,83	343	4809003	NR	02	23,15	340	4821205	NR	02	49,71	341
4703001	NR	01	13,33	343	4809005	NR	02	29,99	340	4821206	NR	02	57,26	341
4703002	NR	01	15,84	343	4809007	NR	02	35,26	340	4821207	NR	02	76,60	341
4703003	NR	01	16,80	343	4809009	NR	02	46,21	340	4821208	NR	02	118,86	341
4703004	NR	01	22,01	343	4809010	NR	02	83,47	340	4821211	NR	02	155,01	341
4703006	NR	01	30,10	343	4809011	NR	02	104,72	340	4825104	NR	02	23,73	342
4703007	NR	01	16,70	343	4820002	NR	02	6,77	341	4825105	NR	02	29,17	342
4703008	NR	01	22,14	343	4820003	NR	02	6,90	341	4825106	NR	02	36,58	342
4711001	NR	03	66,63	345	4820004	NR	02	7,58	341	4825107	NR	02	38,56	342
4711002	NR	03	78,45	345	4820005	NR	02	10,37	341	4825108	NR	02	39,54	342
4711012	NR	03	46,62	345	4820006	NR	02	10,95	341	4825109	NR	02	48,45	342
4711112	NR	03	49,95	345	4820007	NR	02	17,17	341	4826009	NR	02	6,70	342
4711113	NR	03	48,30	345	4820008	NR	02	18,43	341	4826016	NR	02	10,37	342
4730002	NR	02	21,11	344	4820009	NR	02	22,54	341	4826020	NR	02	19,24	342
4730003	NR	02	27,44	344	4820010	NR	02	40,09	341	4826021	NR	02	19,24	342
4730004	NR	02	38,69	344	4820011	NR	02	49,67	341	4826023	NR	02	26,01	342
4730005	NR	02	48,38	344	4820012	NR	02	53,01	341	4826026	NR	02	44,44	342
4730006	NR	02	69,46	344	4820103	NR	02	12,14	341	4826504	NR	02	9,15	342
4740001	NR	02	25,60	345	4820104	NR	02	24,14	341	4826505	NR	02	11,32	342
4740002	NR	02	24,38	345	4820105	NR	02	25,84	341	4826506	NR	02	14,01	342
4740003	NR	02	26,69	345	4820106	NR	02	27,00	341	4826507	NR	02	16,86	342
4740009	NR	02	37,26	345	4820107	NR	02	27,00	341	4826508	NR	02	21,15	342
4740016	NR	02	46,95	345	4820108	NR	02	27,00	341	4826509	NR	02	27,27	342
4744001	NR	09	0,72	345	4820109	NR	02	41,41	341	4830001	NR	02	2,11	337
4744002	NR	09	0,68	345	4820110	NR	02	44,20	341	4830002	NR	02	2,86	337
4744003	NR	09	27,24	345	4820111	NR	02	58,65	341	4830003	NR	02	3,43	337
4744004	NR	09	36,72	345	4820113	NR	02	83,74	341	4830004	NR	02	4,45	337
4744005	NR	09	11,20	345	4820120	NR	02	33,05	341	4830005	NR	02	7,21	337
4744006	NR	09	28,80	345	4820122	NR	02	104,24	341	4830006	NR	02	9,83	337
47450000	NR	10	151,82	65	4821002	NR	02	17,48	342	4830007	NR	02	13,63	337
4801001	NR	02	57,09	340	4821003	NR	02	19,45	342	4830008	NR	02	25,67	337
4801002	NR	02	65,01	340	4821004	NR	02	27,88	342	4830009	NR	02	31,76	337
4801003	NR	02	75,31	340	4821005	NR	02	30,02	342	4830010	NR	02	67,90	337
4801004	NR	02	86,22	340	4821006	NR	02	30,77	342	4831002	NR	02	3,13	337
4801005	NR	02	105,03	340	4821007	NR	02	49,88	342	4831003	NR	02	4,08	337
4802001	NR	02	27,95	340	4821008	NR	02	56,78	342	4831005	NR	02	7,04	337
4802002	NR	02	29,17	340	4821009	NR	02	78,68	342	4831007	NR	02	9,11	337
4802003	NR	02	34,65	340	4821010	NR	02	119,07	342	4831008	NR	02	9,11	337
4802004	NR	02	39,51	340	4821013	NR	02	165,82	342	4832002	NR	02	1,39	337
4802005	NR	02	46,78	340	4821101	NR	02	15,57	341	4832004	NR	02	1,67	337
4802006	NR	02	57,05	340	4821102	NR	02	15,57	341	4832005	NR	02	1,67	337
4802007	NR	02	95,34	340	4821103	NR	02	18,87	341	4832008	NR	02	1,90	337
4802008	NR	02	199,38	340	4821104	NR	02	25,94	341	4832009	NR	02	1,90	337
4805001	NR	02	40,66	340	4821105	NR	02	29,14	341	4832010	NR	02	2,41	337
48066000	NR	10	21,95	69	4821106	NR	02	45,29	341	4832011	NR	02	2,41	337
4808001	NR	02	20,16	340	4821107	NR	02	45,39	341	4832013	NR	02	4,49	337
4808002	NR	02	22,24	340	4821108	NR	02	65,42	341	4832014	NR	02	4,49	337
4808003	NR	02	28,80	340	4821109	NR	02	115,40	341	4832015	NR	02	4,49	337
4808004	NR	02	33,86	340	4821112	NR	02	155,01	341	4832019	NR	02	5,88	337

INDICE PER CODICE ARTICOLO

codice	UM	cat.	euro	pag.	codice	UM	cat.	euro	pag.	codice	UM	cat.	euro	pag.
4832020	NR	02	5,88	337	4838003	NR	02	2,14	338	4853704	NR	03	14,64	295
4832023	NR	02	8,33	337	4838004	NR	02	2,14	338	4853801	NR	03	7,47	295
4832026	NR	02	16,63	337	4838005	NR	02	2,72	338	4853802	NR	03	8,91	295
4832030	NR	02	19,65	337	4838006	NR	02	2,72	338	4853803	NR	03	10,62	295
4832034	NR	02	38,73	337	4838009	NR	02	3,16	338	4853805	NR	03	16,11	295
4833003	NR	02	1,80	337	4838010	NR	02	3,16	338	4853901	NR	03	14,49	295
4833004	NR	02	1,80	337	4838013	NR	02	6,26	338	4853902	NR	03	15,18	295
4833007	NR	02	2,11	337	4838014	NR	02	6,26	338	4854001	NR	03	12,99	295
4833010	NR	02	2,65	337	4838017	NR	02	8,33	338	4854002	NR	03	13,83	295
4833011	NR	02	2,65	337	4838020	NR	02	11,36	338	4854003	NR	03	14,58	295
4833014	NR	02	4,11	337	4838023	NR	02	19,65	338	4854004	NR	03	14,94	295
4833017	NR	02	5,92	337	4838025	NR	02	37,57	338	4854010	NR	03	23,82	295
4833021	NR	02	8,33	337	4841001	NR	02	1,53	338	4854101	NR	03	7,41	295
4833024	NR	02	16,63	337	4841002	NR	02	1,94	338	4854102	NR	03	8,07	295
4833028	NR	02	20,43	337	4841003	NR	02	2,14	338	4854103	NR	03	13,38	295
4833031	NR	02	48,31	337	4841004	NR	02	2,65	338	4854201	NR	03	10,71	295
4834001	NR	02	2,79	338	4841005	NR	02	4,45	338	4854202	NR	03	11,55	295
4834002	NR	02	3,77	338	4841006	NR	02	6,56	338	4880001	NR	07	1,26	339
4834003	NR	02	4,96	338	4841007	NR	02	8,91	338	4880003	NR	07	1,65	339
4834004	NR	02	6,43	338	4841008	NR	02	21,15	338	4880004	NR	07	1,65	339
4834005	NR	02	10,61	338	4841009	NR	02	24,14	338	4880006	NR	07	1,96	339
4834006	NR	02	14,35	338	4845001	NR	02	5,00	338	4880007	NR	07	1,96	339
4834007	NR	02	20,43	338	4845003	NR	02	6,22	338	4880008	NR	07	1,96	339
4834008	NR	02	35,46	338	4853001	NR	03	7,26	294	4880009	NR	07	2,21	339
4834009	NR	02	49,06	338	4853002	NR	03	10,26	294	4880010	NR	07	2,21	339
4835002	NR	02	2,86	337	4853003	NR	03	12,84	294	4880013	NR	07	3,01	339
4835003	NR	02	3,50	337	4853101	NR	03	8,76	294	4880014	NR	07	3,01	339
4835004	NR	02	4,35	337	4853102	NR	03	11,10	294	4880023	NR	07	4,17	339
4835005	NR	02	7,58	337	4853103	NR	03	11,61	294	4882001	NR	07	2,28	339
4835006	NR	02	10,61	337	4853201	NR	03	5,76	294	4882002	NR	07	2,28	339
4835007	NR	02	12,85	337	4853202	NR	03	6,51	294	4882003	NR	07	3,05	339
4835008	NR	02	24,92	337	4853203	NR	03	6,75	294	4882004	NR	07	3,05	339
4835009	NR	02	30,94	337	4853204	NR	03	10,50	294	4882006	NR	07	3,40	339
4835010	NR	02	64,09	337	4853206	NR	03	9,51	294	4882007	NR	07	3,40	339
4836003	NR	02	2,99	338	4853208	NR	03	15,51	294	4882008	NR	07	3,40	339
4836006	NR	02	3,81	338	4853301	NR	03	6,03	294	4882009	NR	07	3,71	339
4836009	NR	02	4,96	338	4853302	NR	03	7,41	294	4882010	NR	07	3,71	339
4836010	NR	02	4,96	338	4853303	NR	03	6,87	294	4882011	NR	07	3,71	339
4836013	NR	02	9,11	338	4853304	NR	03	9,75	294	4882012	NR	07	3,71	339
4836016	NR	02	12,10	338	4853306	NR	03	10,59	294	4882014	NR	07	4,83	339
4836020	NR	02	17,37	338	4853307	NR	03	12,90	294	4882015	NR	07	4,83	339
4836023	NR	02	28,66	338	4853308	NR	03	15,69	294	4882016	NR	07	4,83	339
4836026	NR	02	44,51	338	4853401	NR	03	11,76	295	4882017	NR	07	4,83	339
4837003	NR	02	1,90	338	4853402	NR	03	15,39	295	4882022	NR	07	6,69	339
4837004	NR	02	1,90	338	4853501	NR	03	8,16	295	4882029	NR	07	7,67	339
4837005	NR	02	2,31	338	4853502	NR	03	11,25	295	4882035	NR	07	8,61	339
4837006	NR	02	2,31	338	4853503	NR	03	17,13	295	4884052	NR	07	4,41	339
4837010	NR	02	2,99	338	4853601	NR	03	11,49	295	4884053	NR	07	4,41	339
4837013	NR	02	4,79	338	4853602	NR	03	15,33	295	4890201	MT	05	2,37	294
4837016	NR	02	6,56	338	4853605	NR	03	25,23	295	4890202	MT	05	3,23	294
4837019	NR	02	9,11	338	4853701	NR	03	7,26	295	4890203	MT	05	6,27	294
4837021	NR	02	19,21	338	4853702	NR	03	9,21	295	4890204	MT	05	8,96	294
4837023	NR	02	24,07	338	4853703	NR	03	10,71	295	4890401	MT	05	4,13	294

INDICE PER CODICE ARTICOLO

codice	UM	cat.	euro	pag.	codice	UM	cat.	euro	pag.	codice	UM	cat.	euro	pag.
4890402	MT	05	5,66	294	4894007	NR	05	103,14	297	4894703	NR	05	7,62	298
4890403	MT	05	11,81	294	4894101	NR	05	7,90	297	4894704	NR	05	10,43	298
4891102	MT	05	2,21	296	4894102	NR	05	7,90	297	4894705	NR	05	18,82	298
4891103	MT	05	2,21	296	4894103	NR	05	8,26	297	4894706	NR	05	39,33	298
4891104	MT	05	3,07	296	4894104	NR	05	11,07	297	4894707	NR	05	70,78	298
4891105	MT	05	3,42	296	4894105	NR	05	12,13	297	4894708	NR	05	106,98	298
4891106	MT	05	6,59	296	4894106	NR	05	44,19	297	4894801	NR	05	5,31	298
4891107	MT	05	6,59	296	4894107	NR	05	52,96	297	4894802	NR	05	6,34	298
4891108	MT	05	9,86	296	4894108	NR	05	29,89	297	4894803	NR	05	8,35	298
4891109	MT	05	3,14	296	4894109	NR	05	29,89	297	4894804	NR	05	11,46	298
4891110	MT	05	6,27	296	4894110	NR	05	101,44	297	4894805	NR	05	18,02	298
4891202	MT	05	1,76	296	4894111	NR	05	101,44	297	4894806	NR	05	40,67	298
4891203	MT	05	1,76	296	4894202	NR	05	4,13	297	4894807	NR	05	73,31	298
4891204	MT	05	1,76	296	4894203	NR	05	4,83	297	4895001	NR	05	9,86	298
4891205	MT	05	1,76	296	4894204	NR	05	5,98	297	4895002	NR	05	10,40	298
4891206	MT	05	1,86	296	4894205	NR	05	7,49	297	4895003	NR	05	10,66	298
4891209	MT	05	2,40	296	4894206	NR	05	10,11	297	4895004	NR	05	16,64	298
4891211	MT	05	4,67	296	4894207	NR	05	11,04	297	4895005	NR	05	15,55	298
4891212	MT	05	6,62	296	4894208	NR	05	31,74	297	4895006	NR	05	16,93	298
4891301	MT	05	2,21	296	4894209	NR	05	48,74	297	4895007	NR	05	23,55	298
4891302	MT	05	3,01	296	4894210	NR	05	93,79	297	4895008	NR	05	26,40	298
4891304	MT	05	5,86	296	4894301	NR	05	4,29	297	4895009	NR	05	27,84	298
4891305	MT	05	8,35	296	4894302	NR	05	4,90	297	4895012	NR	05	58,69	298
4891306	MT	05	18,18	296	4894303	NR	05	6,94	297	4895013	NR	05	55,39	298
4891307	MT	05	27,30	296	4894304	NR	05	7,52	297	4895014	NR	05	58,82	298
4891308	MT	05	40,03	296	4894305	NR	05	9,18	297	4895015	NR	05	113,98	298
4891501	MT	05	2,88	297	4894306	NR	05	11,17	297	4895016	NR	05	113,98	298
4891502	MT	05	4,13	297	4894307	NR	05	32,06	297	4895017	NR	05	113,98	298
4891503	MT	05	4,32	297	4894308	NR	05	51,55	297	4895018	NR	05	13,86	298
4891504	MT	05	7,46	297	4894401	NR	05	8,38	298	4895019	NR	05	16,03	298
4891505	MT	05	11,39	297	4894402	NR	05	10,94	298	4895020	NR	05	16,42	298
4892102	MT	05	2,21	296	4894403	NR	05	17,63	298	4895021	NR	05	124,13	298
4892103	MT	05	3,42	296	4894404	NR	05	28,10	298	4895022	NR	05	124,13	298
4892104	MT	05	3,07	296	4894405	NR	05	59,23	298	4895023	NR	05	180,64	298
4892105	MT	05	6,59	296	4894406	NR	05	104,16	298	4895101	NR	05	4,90	299
4892106	MT	05	6,59	296	4894407	NR	05	177,25	298	4895103	NR	05	5,31	299
4892107	MT	05	3,14	296	4894501	NR	05	5,82	298	4895104	NR	05	5,73	299
4892108	MT	05	2,21	296	4894502	NR	05	8,00	298	4895105	NR	05	9,50	299
4892109	MT	05	9,86	296	4894503	NR	05	12,19	298	4895301	NR	05	62,82	299
4892110	MT	05	6,27	296	4894504	NR	05	18,46	298	4895302	NR	05	64,13	299
4892602	MT	05	2,21	297	4894505	NR	05	38,85	298	4895400	NR	05	11,23	299
4892603	MT	05	3,42	297	4894506	NR	05	70,05	298	4895401	NR	05	11,46	299
4892604	MT	05	3,10	297	4894507	NR	05	106,78	298	4895402	NR	05	12,38	299
4892605	MT	05	6,59	297	4894601	NR	05	8,16	299	4895404	NR	05	12,00	299
4892607	MT	05	3,14	297	4894602	NR	05	10,91	299	4895601	NR	05	6,85	301
4892608	MT	05	2,21	297	4894603	NR	05	11,94	299	4895701	NR	05	11,39	301
4892609	MT	05	9,86	297	4894604	NR	05	17,95	299	4895801	NR	05	4,93	301
4894001	NR	05	5,15	297	4894605	NR	05	28,61	299	4896401	NR	05	34,78	301
4894002	NR	05	7,30	297	4894606	NR	05	59,90	299	4897001	NR	05	18,66	298
4894003	NR	05	9,15	297	4894607	NR	05	107,78	299	4897002	NR	05	21,50	298
4894004	NR	05	13,63	297	4894608	NR	05	146,53	299	4897003	NR	05	75,04	298
4894005	NR	05	33,31	297	4894701	NR	05	5,15	298	4897101	NR	05	13,63	299
4894006	NR	05	53,92	297	4894702	NR	05	6,56	298	4897102	NR	05	20,61	299

INDICE PER CODICE ARTICOLO

codice	UM	cat.	euro	pag.	codice	UM	cat.	euro	pag.	codice	UM	cat.	euro	pag.
4898501	NR	05	51,52	301	5810401	NR	20	0,26	281	5901017	NR	03	403,59	283
4898601	NR	05	69,25	301	5810404	NR	20	0,40	281	5901020	NR	03	324,39	283
5800001	NR	22	12,60	279	5810501	NR	20	0,09	281	5901022	NR	03	324,39	283
5800002	NR	22	12,60	279	5810502	NR	20	0,09	281	5901199	NR	03	20,07	283
5800011	NR	22	12,60	279	5810503	NR	20	0,09	281	6000000	NR	10	30,72	272
5800012	NR	22	12,60	279	5810550	NR	20	0,26	281	6000001	NR	10	28,73	272
5800021	NR	22	31,88	279	5810601	NR	22	2,02	280	6000002	NR	10	24,98	272
5800023	NR	22	31,88	279	5810602	NR	22	2,02	280	6000003	NR	10	23,94	272
5800031	NR	22	17,85	279	5810603	NR	22	4,62	280	6000004	NR	10	23,55	272
5800033	NR	20	1,01	281	5810604	NR	22	4,62	280	6000100	NR	10	28,56	276
5800034	NR	20	1,67	281	5850002	NR	06	37,73	210	6000101	NR	10	26,96	276
5800035	NR	22	17,85	279	5850020	NR	06	35,82	238	6000102	NR	10	23,55	276
5800037	NR	20	1,32	281	5850021	NR	06	38,56	238	6000103	NR	10	22,51	276
5800038	NR	20	2,02	281	5850023	NR	06	49,28	238	6000104	NR	10	22,09	276
5800040	NR	20	2,77	281	5850031	NR	09	118,24	168-210	6000200	NR	10	30,72	273
5800050	NR	20	2,99	281	5850040	NR	06	102,78	238	6000201	NR	10	28,73	273
5800051	NR	20	3,39	281	5850045	NR	06	59,40	240	6000202	NR	10	24,98	273
5800060	NR	20	0,26	281	5850046	NR	06	59,40	240	6000203	NR	10	23,94	273
5800061	NR	20	10,69	280	5850050	NR	06	7,99	240	6000204	NR	10	23,55	273
5810001	NR	22	2,10	280	5850051	NR	06	1,73	240	6000210	NR	10	29,54	274
5810002	NR	22	2,10	280	5850052	NR	06	7,24	240	6000211	NR	10	27,38	274
5810003	NR	22	2,10	280	5850060	NR	06	6,37	241	6000212	NR	10	23,94	274
5810004	NR	22	2,10	280	5850061	NR	06	14,58	241	6000213	NR	10	22,90	274
5810005	NR	22	2,10	280	5850082	NR	06	30,02	241	6000214	NR	10	22,51	274
5810006	NR	22	2,10	280	5850084	NR	06	34,78	241	6000400	NR	10	30,72	275
5810007	NR	22	2,48	280	5860001	NR	20	3,43	282	6000401	NR	10	28,73	275
5810008	NR	22	2,48	280	5860002	NR	20	3,43	282	6000402	NR	10	24,98	275
5810017	NR	22	7,48	280	5860003	NR	20	4,75	282	6000403	NR	10	23,94	275
5810018	NR	22	7,48	280	5860004	NR	20	5,28	282	6000404	NR	10	23,55	275
5810019	NR	22	7,48	280	5861002	NR	20	6,69	282	6000600	NR	11	57,86	277
5810020	NR	22	7,48	280	5861003	NR	20	10,74	282	6000601	NR	11	62,81	277
5810021	NR	22	7,48	280	5861004	NR	20	5,59	282	6000602	NR	11	74,39	277
5810022	NR	22	7,48	280	5861005	NR	20	6,25	282	6000603	NR	11	82,65	277
5810100	NR	22	2,02	280	5861006	NR	20	9,28	282	6000604	NR	11	90,92	277
5810101	NR	22	2,02	280	5862001	NR	20	6,38	282	6000605	NR	11	98,37	277
5810102	NR	22	2,02	280	5862002	NR	20	7,17	282	6000606	NR	11	109,10	277
5810103	NR	22	2,02	280	5862003	NR	20	7,83	282	6000610	NR	11	57,86	278
5810104	NR	22	2,02	280	5863001	NR	09	29,92	210	6000611	NR	11	62,81	278
5810105	NR	22	2,02	280	5863002	NR	09	36,32	210	6000612	NR	11	74,39	278
5810108	NR	22	4,75	280	5863101	NR	09	5,44	210	6000613	NR	11	82,65	278
5810109	NR	22	4,75	280	5863201	NR	09	2,80	210	6000614	NR	11	90,92	278
5810110	NR	22	4,75	280	5863301	NR	09	3,60	210	6000615	NR	11	98,37	278
5810111	NR	22	4,75	280	5863401	NR	09	5,52	210	6000616	NR	11	109,10	278
5810112	NR	22	4,75	280	5863501	NR	22	72,41	282	6010007	NR	20	0,40	281
5810113	NR	22	4,75	280	5901001	NR	03	199,32	283	6010009	NR	20	14,92	281
5810114	NR	22	5,04	280	5901002	NR	03	199,32	283	6010015	NR	20	12,45	280
5810115	NR	22	5,04	280	5901005	NR	03	249,48	283	6010018	NR	20	7,30	281
5810116	NR	22	6,05	280	5901006	NR	03	403,59	283	6010019	NR	20	1,14	281
5810117	NR	22	6,05	280	5901011	NR	03	199,32	283	6010020	NR	20	0,70	281
5810301	NR	22	2,10	279	5901012	NR	03	249,48	283	6010031	NR	22	18,19	279
5810302	NR	22	2,10	279	5901013	NR	03	199,32	283	6010033	NR	22	18,02	279
5810305	NR	22	7,35	279	5901014	NR	03	249,48	283	6101001	NR	15	101,34	257
5810306	NR	22	7,35	279	5901016	NR	03	403,59	283	6101002	NR	15	103,01	257

INDICE PER CODICE ARTICOLO

codice	UM	cat.	euro	pag.	codice	UM	cat.	euro	pag.	codice	UM	cat.	euro	pag.
6101003	NR	15	105,23	257	6122902	NR	03	308,28	255	6176003	NR	13	487,08	246
6101004	NR	15	106,93	257	6122903	NR	03	355,20	255	6176004	NR	13	487,08	246
6101005	NR	15	109,71	257	6122904	NR	03	387,57	255	6177001	NR	13	774,90	246
6101009	NR	15	132,68	257	6160001	NR	11	185,75	251	6177002	NR	13	774,90	246
6101010	NR	15	134,90	257	6160002	NR	11	194,88	251	6177003	NR	13	722,32	246
6101011	NR	15	139,38	257	6160003	NR	11	240,56	251	6177004	NR	13	722,32	246
6101012	NR	15	141,64	257	6161001	NR	11	149,21	251	6177005	NR	13	821,95	246
6101013	NR	15	145,56	257	6161002	NR	11	161,39	251	6177006	NR	13	821,95	246
6101015	NR	15	171,87	257	6161003	NR	11	188,79	251	6190001	NR	09	21,64	261
6101017	NR	15	153,96	257	6170001	NR	11	217,92	250	6190002	NR	09	28,80	261
6101018	NR	15	157,88	257	6170002	NR	11	226,66	250	6190003	NR	09	127,80	261
6101019	NR	15	160,10	257	6170003	NR	11	257,42	250	6190004	NR	09	138,20	261
6101020	NR	15	163,47	257	6170004	NR	11	323,88	250	6190006	NR	09	175,00	261
6101021	NR	15	166,28	257	6170005	NR	11	323,88	250	6190009	NR	09	35,08	261
6101023	NR	15	202,65	257	6170006	NR	11	335,66	250	6190010	NR	09	35,08	261
6101025	NR	15	189,77	257	6170007	NR	11	385,80	250	6191001	NR	09	157,44	261
6101026	NR	15	192,59	257	6171001	NR	11	164,77	251	6191002	NR	09	166,64	261
6101027	NR	15	196,51	257	6171002	NR	11	173,01	251	6191003	NR	09	177,92	261
6101028	NR	15	198,73	257	6171003	NR	11	179,59	251	6191004	NR	09	210,04	261
6101029	NR	15	202,65	257	6171004	NR	11	187,89	251	6191009	NR	09	161,16	261
6101031	NR	15	236,25	257	6171005	NR	11	218,61	251	6191010	NR	09	161,16	261
6101903	NR	15	180,71	258	6171006	NR	11	343,96	250	6191011	NR	09	187,04	261
6101911	NR	15	239,02	258	6171007	NR	11	343,96	250	6191012	NR	09	216,32	261
6101919	NR	15	274,43	258	6172001	NR	11	276,37	250	6191101	NR	09	166,64	260
6101927	NR	15	337,14	258	6172002	NR	11	276,37	250	6191102	NR	09	203,36	260
6111001	NR	15	210,20	259	6172003	NR	11	342,17	250	6191105	NR	09	122,76	260
6111002	NR	15	219,71	259	6172004	NR	11	342,17	250	6191106	NR	09	314,44	260
6111003	NR	15	232,99	259	6172005	NR	11	267,60	250	6191107	NR	09	347,84	260
6111004	NR	15	251,38	259	6172006	NR	11	267,60	250	6191108	NR	09	347,84	260
6111005	NR	15	263,37	259	6173001	NR	10	275,18	249	6191201	NR	09	180,40	260
6111006	NR	15	285,49	259	6173002	NR	10	296,35	249	6191202	NR	09	278,12	260
6111007	NR	15	299,44	259	6173003	NR	10	323,57	249	6191402	NR	09	26,60	260
6111008	NR	15	317,16	259	6173004	NR	10	381,02	249	6191403	NR	09	82,92	261
6111009	NR	15	336,18	259	6173005	NR	10	423,36	249	6191404	NR	09	103,56	260
6111010	NR	15	355,16	259	6173006	NR	10	337,18	249	6191405	NR	09	121,52	260
6111013	NR	15	358,97	259	6173007	NR	10	359,86	249	6191406	NR	09	28,80	260
6111014	NR	15	384,32	259	6173008	NR	10	393,12	249	6191409	NR	09	20,88	260
6111015	NR	15	406,45	259	6173009	NR	10	438,48	249	6191411	NR	09	20,88	260
6111016	NR	15	431,16	259	6173010	NR	10	450,58	249	6191412	NR	09	24,64	260
6111018	NR	15	388,06	259	6174001	NR	10	374,98	249	6191413	NR	09	20,88	260
6111019	NR	15	406,45	259	6174002	NR	10	447,55	249	6200003	NR	07	4,13	319
6111020	NR	15	434,31	259	6174003	NR	10	544,32	249	6200004	NR	07	2,00	319
6111021	NR	15	461,54	259	6174004	NR	10	574,56	249	6200005	NR	07	1,51	319
6111022	NR	15	489,40	259	6175001	NR	17	2.025,40	248	6200007	NR	07	1,68	319
6122001	NR	02	287,71	254	6175002	NR	17	2.118,68	248	6200008	NR	07	2,00	319
6122002	NR	02	302,06	254	6175003	NR	17	3.445,85	248	6200010	NR	07	2,77	319
6122003	NR	02	346,77	254	6175004	NR	17	3.539,12	248	6200012	NR	07	6,97	319
6122004	NR	02	405,25	254	6175005	NR	17	3.651,05	248	6200014	NR	07	20,58	319
6122011	NR	03	411,90	256	6175006	NR	17	3.731,00	248	6200016	NR	07	31,71	319
6122012	NR	03	462,24	256	6175007	NR	17	2.686,32	248	6200018	NR	07	53,83	319
6122013	NR	03	529,59	256	6175008	NR	17	2.798,25	248	6201003	NR	07	1,82	319
6122014	NR	03	588,42	256	6176001	NR	13	381,92	246	6201004	NR	07	1,05	319
6122901	NR	03	289,50	255	6176002	NR	13	381,92	246	6201005	NR	07	1,19	319

INDICE PER CODICE ARTICOLO

codice	UM	cat.	euro	pag.	codice	UM	cat.	euro	pag.	codice	UM	cat.	euro	pag.
6201007	NR	07	1,47	319	6210005	NR	07	1,26	320	6212147	NR	07	31,33	321
6201008	NR	07	1,47	319	6210007	NR	07	1,54	320	6222006	NR	07	1,65	321
6201010	NR	07	2,14	319	6210008	NR	07	2,00	320	6222007	NR	07	1,44	321
6201012	NR	07	3,61	319	6210010	NR	07	3,01	320	6222013	NR	07	1,75	321
6201014	NR	07	11,24	319	6210012	NR	07	7,53	320	6222014	NR	07	1,51	321
6201016	NR	07	15,65	319	6210014	NR	07	20,62	320	6222016	NR	07	5,01	321
6201018	NR	07	41,58	319	6210016	NR	07	32,24	320	6222017	NR	07	3,61	321
6202002	NR	07	5,36	319	6210018	NR	07	54,29	320	6222018	NR	07	2,10	321
6202003	NR	07	5,36	319	6211003	NR	07	3,61	320	6222020	NR	07	2,42	321
6202006	NR	07	5,67	319	6211004	NR	07	1,54	320	6222022	NR	07	3,33	321
6202007	NR	07	6,76	319	6211005	NR	07	1,37	320	6222024	NR	07	3,99	321
6202008	NR	07	6,83	319	6211007	NR	07	1,75	320	6222025	NR	07	3,19	321
6202009	NR	07	8,79	319	6211008	NR	07	2,59	320	6222032	NR	07	7,35	321
6203002	NR	07	4,59	319	6211009	NR	07	3,64	320	6222033	NR	07	4,27	321
6203003	NR	07	2,21	319	6211012	NR	07	7,14	320	6222041	NR	07	13,90	321
6203004	NR	07	1,79	319	6211013	NR	07	20,65	320	6222042	NR	07	17,54	321
6203006	NR	07	2,28	319	6211014	NR	07	39,03	320	6222050	NR	07	19,67	321
6203007	NR	07	2,31	319	6211016	NR	07	62,69	320	6224006	NR	07	2,49	321
6203009	NR	07	2,35	319	6212025	NR	07	3,05	321	6224008	NR	07	1,23	321
6203011	NR	07	4,69	319	6212026	NR	07	2,56	321	6224014	NR	07	1,61	321
6203013	NR	07	17,54	319	6212048	NR	07	4,41	321	6224015	NR	07	1,23	321
6203015	NR	07	28,53	319	6212050	NR	07	3,61	321	6224017	NR	07	2,73	321
6203017	NR	07	46,52	319	6212053	NR	07	3,12	321	6224018	NR	07	1,79	321
6204003	NR	07	4,66	319	6212061	NR	07	11,76	321	6224020	NR	07	1,96	321
6204004	NR	07	2,28	319	6212065	NR	07	7,11	321	6224022	NR	07	5,64	321
6204005	NR	07	1,47	319	6212067	NR	07	6,69	321	6224023	NR	07	2,84	321
6204007	NR	07	1,72	319	6212068	NR	07	6,02	321	6224025	NR	07	2,28	321
6204008	NR	07	2,24	319	6212069	NR	07	3,57	321	6224026	NR	07	1,89	321
6204010	NR	07	2,56	319	6212074	NR	07	6,37	321	6224031	NR	07	12,50	321
6204012	NR	07	4,59	319	6212075	NR	07	5,85	321	6224032	NR	07	8,09	321
6204014	NR	07	15,93	319	6212077	NR	07	6,27	321	6224034	NR	07	8,33	321
6204016	NR	07	26,04	319	6212081	NR	07	10,33	321	6224035	NR	07	6,44	321
6204018	NR	07	46,52	319	6212088	NR	07	10,75	321	6224036	NR	07	3,01	321
6206002	NR	07	10,99	320	6212089	NR	07	10,64	321	6224041	NR	07	13,02	321
6206004	NR	07	12,29	320	6212091	NR	07	11,31	321	6224042	NR	07	9,56	321
6206005	NR	07	14,42	320	6212092	NR	07	5,67	321	6224046	NR	07	21,46	321
6206006	NR	07	19,60	320	6212098	NR	07	10,12	321	6224047	NR	07	19,46	321
6207002	NR	07	8,51	320	6212099	NR	07	10,47	321	6224048	NR	07	16,45	321
6207004	NR	07	11,27	320	6212100	NR	07	5,92	321	6224052	NR	07	36,89	321
6207005	NR	07	11,90	320	6212101	NR	07	8,75	321	6224053	NR	07	38,08	321
6207006	NR	07	16,63	320	6212104	NR	07	7,81	321	6224054	NR	07	30,91	321
6208003	NR	07	2,28	320	6212105	NR	07	5,01	321	6226002	NR	07	1,58	322
6208004	NR	07	0,91	320	6212107	NR	07	10,01	321	6226003	NR	07	0,60	322
6208005	NR	07	0,84	320	6212110	NR	07	11,38	321	6226004	NR	07	0,42	322
6208007	NR	07	1,16	320	6212111	NR	07	19,22	321	6226005	NR	07	0,46	322
6208008	NR	07	1,23	320	6212112	NR	07	22,30	321	6226007	NR	07	0,60	322
6208010	NR	07	1,89	320	6212113	NR	07	16,38	321	6226008	NR	07	0,74	322
6208012	NR	07	3,19	320	6212119	NR	07	15,47	321	6226010	NR	07	1,02	322
6208014	NR	07	13,90	320	6212123	NR	07	12,92	321	6226012	NR	07	2,14	322
6208016	NR	07	25,06	320	6212127	NR	07	15,23	321	6226014	NR	07	5,32	322
6208018	NR	07	45,96	320	6212128	NR	07	8,37	321	6226016	NR	07	9,70	322
6210003	NR	07	3,33	320	6212133	NR	07	19,15	321	6226017	NR	07	16,45	322
6210004	NR	07	1,93	320	6212143	NR	07	23,59	321	6229003	NR	07	2,70	322

INDICE PER CODICE ARTICOLO

codice	UM	cat.	euro	pag.	codice	UM	cat.	euro	pag.	codice	UM	cat.	euro	pag.
6229004	NR	07	2,07	322	6410008	NR	02	2,52	323	6420014	NR	02	21,49	324
6229005	NR	07	1,96	322	6410009	NR	02	2,62	323	6420015	NR	02	16,59	324
6229007	NR	07	2,03	322	6410010	NR	02	2,04	323	6420016	NR	02	33,12	324
6229008	NR	07	2,28	322	6410011	NR	02	5,54	323	6420017	NR	02	31,35	324
6229009	NR	07	3,47	322	6410016	NR	02	2,55	323	6420018	NR	02	53,72	324
6229010	NR	07	4,76	322	6410017	NR	02	3,81	323	6430004	NR	02	8,19	324
6229011	NR	07	14,91	322	6410018	NR	02	2,99	323	6430006	NR	02	8,16	324
6229012	NR	07	24,96	322	6410019	NR	02	3,13	323	6430009	NR	02	10,74	324
6229013	NR	07	35,63	322	6410020	NR	02	4,79	323	6431002	NR	02	4,45	324
6231003	NR	07	3,12	322	6410021	NR	02	3,71	323	6431004	NR	02	4,83	324
6231004	NR	07	3,33	322	6410022	NR	02	5,51	323	6431009	NR	02	5,34	324
6231005	NR	07	5,04	322	6410024	NR	02	7,45	323	6431010	NR	02	7,14	324
6231006	NR	07	3,15	322	6410025	NR	02	5,58	323	6431011	NR	02	11,90	324
6231007	NR	07	4,97	322	6410026	NR	02	12,21	323	6500001	NR	07	6,97	313
6231008	NR	07	5,08	322	6410027	NR	02	12,24	323	6500003	NR	07	7,07	313
6231009	NR	07	5,22	322	6410028	NR	02	9,89	323	6500004	NR	07	5,92	313
6231010	NR	07	10,12	322	6410030	NR	02	26,18	323	6500006	NR	07	6,30	313
6402005	NR	02	3,74	323	6410031	NR	02	22,10	323	6500009	NR	07	7,46	313
6402007	NR	02	3,84	323	6410033	NR	02	50,12	323	6500010	NR	07	6,90	313
6402013	NR	02	4,15	323	6410034	NR	02	46,10	323	6500014	NR	07	7,56	313
6402015	NR	02	4,56	323	6412004	NR	02	6,22	324	6500016	NR	07	9,35	313
6402016	NR	02	6,39	323	6412005	NR	02	3,23	324	6500020	NR	07	11,38	313
6402017	NR	02	7,79	323	6412006	NR	02	3,77	324	6502002	NR	07	5,74	313
6402018	NR	02	7,31	323	6412007	NR	02	3,91	324	6502003	NR	07	6,83	313
6402019	NR	02	14,14	323	6412008	NR	02	3,77	324	6502005	NR	07	5,74	313
6402020	NR	02	14,76	323	6412014	NR	02	3,84	324	6502006	NR	07	4,87	313
6402021	NR	02	19,92	323	6412015	NR	02	6,97	324	6502008	NR	07	5,43	313
6402022	NR	02	28,49	323	6412016	NR	02	3,64	324	6502009	NR	07	4,45	313
6402023	NR	02	34,85	323	6412017	NR	02	5,10	324	6502011	NR	07	4,24	313
6403006	NR	02	5,41	323	6412018	NR	02	5,34	324	6502012	NR	07	8,05	313
6403008	NR	02	5,03	323	6412019	NR	02	5,64	324	6502016	NR	07	7,18	313
6403012	NR	02	5,92	323	6412020	NR	02	8,74	324	6502017	NR	07	7,46	313
6403014	NR	02	6,77	323	6412022	NR	02	9,35	324	6502020	NR	07	11,66	313
6403015	NR	02	10,74	323	6412023	NR	02	10,13	324	6502022	NR	07	9,07	313
6403016	NR	02	12,92	323	6412026	NR	02	15,61	324	6502023	NR	07	15,16	313
6403017	NR	02	10,20	323	6412027	NR	02	17,51	324	6502027	NR	07	29,19	313
6403020	NR	02	19,92	323	6412029	NR	02	29,72	324	6503003	NR	07	8,93	313
6403021	NR	02	54,09	323	6412030	NR	02	31,18	324	6503004	NR	07	7,39	313
6406012	NR	02	27,30	323	6412031	NR	02	42,02	324	6503005	NR	07	6,37	313
6406013	NR	02	26,76	323	6412032	NR	02	53,21	324	6503008	NR	07	10,89	313
6407004	NR	02	6,19	323	6417008	NR	02	18,46	324	6503009	NR	07	10,85	313
6407006	NR	02	6,26	323	6417009	NR	02	28,22	324	6503010	NR	07	12,81	313
6407011	NR	02	6,90	323	6419011	NR	02	15,47	324	6503011	NR	07	22,61	313
6407014	NR	02	7,89	323	6419014	NR	02	18,63	324	6503012	NR	07	13,44	313
6407015	NR	02	11,12	323	6419015	NR	02	20,88	324	6503013	NR	07	13,02	313
6407017	NR	02	9,52	323	6419016	NR	02	25,67	324	6503014	NR	07	21,84	313
6407018	NR	02	14,25	323	6419017	NR	02	34,48	324	6503016	NR	07	5,71	313
6407019	NR	02	17,75	323	6419018	NR	02	33,56	324	6503017	NR	07	6,37	313
6407020	NR	02	14,72	323	6420005	NR	02	11,46	324	6504001	NR	07	5,11	313
6407021	NR	02	26,93	323	6420010	NR	02	11,83	324	6504003	NR	07	4,66	313
6410004	NR	02	2,79	323	6420011	NR	02	23,80	324	6504004	NR	07	5,08	313
6410005	NR	02	3,26	323	6420012	NR	02	13,94	324	6504005	NR	07	4,76	313
6410007	NR	02	2,14	323	6420013	NR	02	16,59	324	6504006	NR	07	6,02	313

INDICE PER CODICE ARTICOLO

codice	UM	cat.	euro	pag.	codice	UM	cat.	euro	pag.	codice	UM	cat.	euro	pag.
6504008	NR	07	8,05	313	6553001	NR	10	7,81	300	6603009	NR	01	6,24	315
6504011	NR	07	6,55	313	6553002	NR	10	11,51	300	6603010	NR	01	7,89	315
6504012	NR	07	9,66	313	6553003	NR	10	17,98	300	6603011	NR	01	6,93	315
6504013	NR	07	8,96	313	6553004	NR	10	29,90	300	6603012	NR	01	7,89	315
6504014	NR	07	8,47	313	6554001	NR	10	5,35	300	6603015	NR	01	10,16	315
6504017	NR	07	13,65	313	6554003	NR	10	7,56	300	6603016	NR	01	14,09	315
6504019	NR	07	11,06	313	6554004	NR	10	7,87	300	6603017	NR	01	17,46	315
6504020	NR	07	17,40	313	6554005	NR	10	13,24	300	6603018	NR	01	16,93	315
6504022	NR	07	18,62	313	6554006	NR	10	21,28	300	6604001	NR	01	7,66	315
6506003	NR	07	9,80	313	6555001	NR	10	5,26	300	6604002	NR	01	8,42	315
6506004	NR	07	7,81	313	6555003	NR	10	7,95	300	6604003	NR	01	9,47	315
6506005	NR	07	8,75	313	6555004	NR	10	8,29	300	6604004	NR	01	11,48	315
6506009	NR	07	9,59	313	6555005	NR	10	13,05	300	6604005	NR	01	13,83	315
6506010	NR	07	14,70	313	6555006	NR	10	16,02	300	6604006	NR	01	20,82	315
6506013	NR	07	15,16	313	6555007	NR	10	22,68	300	6605002	NR	01	7,92	316
6507001	NR	07	10,78	314	6556001	NR	10	6,72	301	6605003	NR	01	6,50	316
6507003	NR	07	6,79	314	6556003	NR	10	9,35	301	6605004	NR	01	6,47	316
6507009	NR	07	12,08	314	6557001	NR	10	10,44	301	6605006	NR	01	6,80	316
6507013	NR	07	14,81	314	6557002	NR	10	16,21	301	6605009	NR	01	8,25	316
6508002	NR	07	11,06	314	6557003	NR	10	27,16	301	6605010	NR	01	10,82	316
6508004	NR	07	9,00	314	6557004	NR	10	45,30	301	6605011	NR	01	11,15	316
6508008	NR	07	9,42	314	6559001	NR	10	8,99	301	6605012	NR	01	10,56	316
6508011	NR	07	16,21	314	6559003	NR	10	13,22	301	6605014	NR	01	17,52	316
6508013	NR	07	13,93	314	6559004	NR	10	13,24	301	6606001	NR	01	6,63	316
6509002	NR	07	9,00	314	6601001	NR	01	5,25	315	6606002	NR	01	7,82	316
6509003	NR	07	8,54	314	6601002	NR	01	6,44	315	6606003	NR	01	8,02	316
6509004	NR	07	7,67	314	6601003	NR	01	7,19	315	6606004	NR	01	7,23	316
6509006	NR	07	8,23	314	6601004	NR	01	8,65	315	6606006	NR	01	7,46	316
6509010	NR	07	9,07	314	6601005	NR	01	10,00	315	6606009	NR	01	8,84	316
6509011	NR	07	14,53	314	6601006	NR	01	16,17	315	6606010	NR	01	12,14	316
6509012	NR	07	11,66	314	6601007	NR	01	20,86	315	6606011	NR	01	12,41	316
6509013	NR	07	12,67	314	6602001	NR	01	3,40	315	6606012	NR	01	10,76	316
6509017	NR	07	14,81	314	6602002	NR	01	4,26	315	6606014	NR	01	18,08	316
6510001	NR	07	16,80	314	6602003	NR	01	3,76	315	6606015	NR	01	22,80	316
6510002	NR	07	16,52	314	6602004	NR	01	3,93	315	6606017	NR	01	29,87	316
6510003	NR	07	14,81	314	6602005	NR	01	4,95	315	6607001	NR	01	12,71	316
6511001	NR	07	16,35	314	6602006	NR	01	4,49	315	6607002	NR	01	10,00	316
6550001	NR	10	6,80	300	6602007	NR	01	6,34	315	6607003	NR	01	11,68	316
6550002	NR	10	10,50	300	6602009	NR	01	5,21	315	6607004	NR	01	12,67	316
6550003	NR	10	16,74	300	6602010	NR	01	7,39	315	6608001	NR	01	12,84	316
6550004	NR	10	27,94	300	6602011	NR	01	6,47	315	6608002	NR	01	11,39	316
6552001	NR	10	3,56	300	6602012	NR	01	7,16	315	6608003	NR	01	12,77	316
6552003	NR	10	5,96	300	6602015	NR	01	10,49	315	6608004	NR	01	15,97	316
6552004	NR	10	6,22	300	6602016	NR	01	13,23	315	6608005	NR	01	20,39	316
6552005	NR	10	10,78	300	6602017	NR	01	15,84	315	6608006	NR	01	30,72	316
6552006	NR	10	12,10	300	6602018	NR	01	15,71	315	6609002	NR	01	11,19	316
6552007	NR	10	18,48	300	6603001	NR	01	4,03	315	6609004	NR	01	11,95	316
6552008	NR	10	4,20	300	6603002	NR	01	4,32	315	6609005	NR	01	13,00	316
6552010	NR	10	6,13	300	6603003	NR	01	4,46	315	6609006	NR	01	16,14	316
6552011	NR	10	6,94	300	6603004	NR	01	4,52	315	6609008	NR	01	17,89	316
6552012	NR	10	10,72	300	6603005	NR	01	5,08	315	6609011	NR	01	27,46	316
6552013	NR	10	12,04	300	6603006	NR	01	4,69	315	6620002	NR	01	20,69	331
6552014	NR	10	17,42	300	6603007	NR	01	7,43	315	6620004	NR	01	20,96	331

INDICE PER CODICE ARTICOLO

codice	UM	cat.	euro	pag.	codice	UM	cat.	euro	pag.	codice	UM	cat.	euro	pag.
6620005	NR	01	32,31	331	6631004	NR	01	18,58	332	6643024	NR	01	12,08	329
6620007	NR	01	33,86	331	6631005	NR	01	22,47	332	6643027	NR	01	22,77	330
6620008	NR	01	50,95	331	6631006	NR	01	26,73	332	6643029	NR	01	31,48	330
6621002	NR	01	13,07	331	6631007	NR	01	40,03	332	6643030	NR	01	30,76	330
6621004	NR	01	13,07	331	6631008	NR	01	40,89	332	6643031	NR	01	22,70	330
6621006	NR	01	28,15	331	6631009	NR	01	56,96	332	6643035	NR	01	20,06	329
6621007	NR	01	31,94	331	6631010	NR	01	71,31	332	6643037	NR	01	35,61	330
6621008	NR	01	33,59	331	6636001	NR	01	17,19	332	6643039	NR	01	30,89	330
6621009	NR	01	20,56	331	6636002	NR	01	14,26	332	6643041	NR	01	32,57	330
6621011	NR	01	36,50	331	6636003	NR	01	23,46	332	6643042	NR	01	33,89	329
6621012	NR	01	61,84	331	6636004	NR	01	38,48	332	6643043	NR	01	59,04	330
6624001	NR	01	20,16	331	6637001	NR	01	3,83	329	6643044	NR	01	59,90	330
6624003	NR	01	19,54	331	6637002	NR	01	3,83	329	6643046	NR	01	62,01	330
6624004	NR	01	34,25	331	6637003	NR	01	5,18	329	6643047	NR	01	65,97	329
6624005	NR	01	26,76	331	6637004	NR	01	6,77	329	6643048	NR	01	92,60	330
6624006	NR	01	40,56	331	6637005	NR	01	15,44	329	6643049	NR	01	95,47	330
6624007	NR	01	33,63	331	6637006	NR	01	28,55	329	6643050	NR	01	99,00	330
6624008	NR	01	45,90	331	6637007	NR	01	56,33	329	6643053	NR	01	81,44	329
6624009	NR	01	49,34	331	6637008	NR	01	75,44	329	6644001	NR	01	11,12	330
6626002	NR	01	4,88	331	6638001	NR	01	4,13	329	6644002	NR	01	15,97	330
6626004	NR	01	4,62	331	6638002	NR	01	4,06	329	6644003	NR	01	17,49	330
6626005	NR	01	9,11	331	6638003	NR	01	5,31	329	6644004	NR	01	17,82	330
6626006	NR	01	5,74	331	6638004	NR	01	6,80	329	6644005	NR	01	20,03	330
6626007	NR	01	6,93	331	6638005	NR	01	13,79	329	6644006	NR	01	28,15	330
6626008	NR	01	9,37	331	6638006	NR	01	28,28	329	6644007	NR	01	41,91	330
6626009	NR	01	8,55	331	6638007	NR	01	53,89	329	6644008	NR	01	46,89	330
6626010	NR	01	11,52	331	6638008	NR	01	74,55	329	6645001	NR	01	3,53	330
6626011	NR	01	25,38	331	6639001	NR	01	3,63	329	6645002	NR	01	3,56	330
6626012	NR	01	15,58	331	6639002	NR	01	3,76	329	6645003	NR	01	3,56	330
6626014	NR	01	35,05	331	6639003	NR	01	4,79	329	6645004	NR	01	4,22	330
6626015	NR	01	34,82	331	6639004	NR	01	5,51	329	6645005	NR	01	4,36	330
6626016	NR	01	37,52	331	6639005	NR	01	18,45	329	6645006	NR	01	10,76	330
6626017	NR	01	47,36	331	6639006	NR	01	26,33	329	6645007	NR	01	11,06	330
6626018	NR	01	48,58	331	6639007	NR	01	41,25	329	6645008	NR	01	11,29	330
6626020	NR	01	93,65	331	6639008	NR	01	61,15	329	6645009	NR	01	13,37	330
6628002	NR	01	6,07	332	6640001	NR	01	4,59	329	6645010	NR	01	14,69	330
6628004	NR	01	5,74	332	6640002	NR	01	4,62	329	6645011	NR	01	22,77	330
6628006	NR	01	7,56	332	6640003	NR	01	4,75	329	6645012	NR	01	22,21	330
6628007	NR	01	14,78	332	6640004	NR	01	5,97	329	6645013	NR	01	21,78	330
6628008	NR	01	8,55	332	6640005	NR	01	18,91	329	6645014	NR	01	30,29	330
6628009	NR	01	9,14	332	6640006	NR	01	27,19	329	6645015	NR	01	29,07	330
6628010	NR	01	13,46	332	6640007	NR	01	44,32	329	6646001	NR	01	3,83	330
6628011	NR	01	29,70	332	6640008	NR	01	62,01	329	6646002	NR	01	3,93	330
6628012	NR	01	16,73	332	6643001	NR	01	6,73	329	6646003	NR	01	4,82	330
6628013	NR	01	31,61	332	6643004	NR	01	7,89	330	6646004	NR	01	5,91	330
6628014	NR	01	38,61	332	6643005	NR	01	14,92	330	6646005	NR	01	11,45	330
6628015	NR	01	38,15	332	6643006	NR	01	6,96	329	6646006	NR	01	14,19	330
6628016	NR	01	53,92	332	6643009	NR	01	8,94	330	6646007	NR	01	26,63	330
6628017	NR	01	55,14	332	6643011	NR	01	8,51	330	6646008	NR	01	33,56	330
6628018	NR	01	96,13	332	6643013	NR	01	9,34	329	6648001	NR	01	8,32	330
6631001	NR	01	16,70	332	6643015	NR	01	11,45	330	6648002	NR	01	8,32	330
6631002	NR	01	18,05	332	6643018	NR	01	10,43	330	6648003	NR	01	10,56	330
6631003	NR	01	18,05	332	6643021	NR	01	12,11	330	6648004	NR	01	14,03	330

INDICE PER CODICE ARTICOLO

codice	UM	cat.	euro	pag.	codice	UM	cat.	euro	pag.	codice	UM	cat.	euro	pag.
6648005	NR	01	21,62	330	6671001	NR	01	4,75	333	6751005	NR	10	32,42	242-335
6648006	NR	01	24,06	330	6671002	NR	01	6,04	333	6751006	NR	10	33,60	242-335
6648007	NR	01	37,39	330	6671003	NR	01	7,06	333	6751007	NR	10	35,95	242-335
6648008	NR	01	45,57	330	6671004	NR	01	20,03	333	6751008	NR	10	40,63	242-335
6662001	NR	01	21,91	334	6671005	NR	01	27,59	333	6751009	NR	10	60,26	242-335
6662002	NR	01	33,96	334	6672001	NR	01	6,04	333	6752001	NR	10	19,54	242-335
6662003	NR	01	34,06	334	6672002	NR	01	6,63	333	6752002	NR	10	19,54	242-335
6662004	NR	01	35,77	334	6672003	NR	01	7,89	333	6752003	NR	10	22,65	242-335
6662005	NR	01	52,67	334	6672004	NR	01	21,48	333	6752004	NR	10	25,00	242-335
6663001	NR	01	13,89	334	6672005	NR	01	30,00	333	6752005	NR	10	30,46	242-335
6663003	NR	01	30,13	334	6673001	NR	01	8,09	333	6752006	NR	10	32,03	242-335
6663004	NR	01	34,12	334	6673002	NR	01	10,96	333	6752007	NR	10	35,17	242-335
6663005	NR	01	35,77	334	6673003	NR	01	10,43	333	6752008	NR	10	37,52	242-335
6663006	NR	01	22,01	334	6673005	NR	01	12,41	333	6752009	NR	10	83,64	242-335
6663008	NR	01	38,28	334	6673006	NR	01	13,66	333	6753001	NR	10	25,90	243-336
6664001	NR	01	21,62	334	6673007	NR	01	19,80	333	6753002	NR	10	27,33	243-336
6664002	NR	01	36,14	334	6673008	NR	01	13,73	333	6753003	NR	10	33,60	243-336
6664003	NR	01	29,40	334	6673009	NR	01	26,04	333	6753004	NR	10	34,38	243-336
6664004	NR	01	42,64	334	6673010	NR	01	26,33	333	6753005	NR	10	35,95	243-336
6664006	NR	01	48,54	334	6673011	NR	01	22,67	333	6753006	NR	10	38,67	243-336
6665001	NR	01	5,31	334	6673012	NR	01	33,89	333	6753007	NR	10	34,75	243-336
6665002	NR	01	10,33	334	6673013	NR	01	35,84	333	6753008	NR	10	36,34	243-336
6665003	NR	01	6,90	334	6673014	NR	01	36,73	333	6753009	NR	10	40,63	243-336
6665004	NR	01	8,09	334	6674001	NR	01	4,92	333	6753010	NR	10	41,41	243-336
6665005	NR	01	11,15	334	6674002	NR	01	5,15	333	6753011	NR	10	43,76	243-336
6665006	NR	01	10,26	334	6674003	NR	01	5,41	333	6753012	NR	10	44,55	243-336
6665007	NR	01	13,17	334	6674004	NR	01	12,57	333	6753013	NR	10	46,90	243-336
6665008	NR	01	26,86	334	6674005	NR	01	12,77	333	6753014	NR	10	48,44	243-336
6665009	NR	01	17,13	334	6674006	NR	01	13,23	333	6753015	NR	10	53,14	243-336
6665011	NR	01	37,79	334	6674007	NR	01	15,91	333	6753016	NR	10	55,36	243-336
6665012	NR	01	37,42	334	6674008	NR	01	16,83	333	6753017	NR	10	62,72	243-336
6665013	NR	01	40,16	334	6675001	NR	01	5,41	334	6753018	NR	10	65,58	243-336
6666001	NR	01	6,80	334	6675002	NR	01	6,70	334	6753019	NR	10	67,26	243-336
6666003	NR	01	8,68	334	6675003	NR	01	7,89	334	6753020	NR	10	34,19	243-336
6666004	NR	01	16,30	334	6675004	NR	01	13,99	334	6755001	NR	10	21,08	243-336
6666005	NR	01	10,30	334	6675005	NR	01	17,09	334	6755002	NR	10	20,33	243-336
6666006	NR	01	10,82	334	6676001	NR	01	10,20	334	6755003	NR	10	19,15	243-336
6666007	NR	01	13,89	334	6676002	NR	01	12,80	334	6755004	NR	10	19,15	243-336
6666008	NR	01	18,45	334	6676003	NR	01	16,37	334	6755005	NR	10	25,79	243-336
6666009	NR	01	40,89	334	6676004	NR	01	24,62	334	6755006	NR	10	28,14	243-336
6668001	NR	01	15,18	334	6676005	NR	01	27,59	334	6755007	NR	10	21,08	243-336
6668002	NR	01	25,31	334	6750001	NR	10	19,54	242-335	6755008	NR	10	22,65	243-336
6668003	NR	01	40,16	334	6750002	NR	10	21,08	242-335	6755009	NR	10	23,44	243-336
6669001	NR	01	4,82	333	6750003	NR	10	23,44	242-335	6755010	NR	10	27,36	243-336
6669002	NR	01	6,17	333	6750004	NR	10	26,57	242-335	6755011	NR	10	28,92	243-336
6669003	NR	01	8,12	333	6750005	NR	10	28,14	242-335	6755012	NR	10	30,46	243-336
6669004	NR	01	17,56	333	6750006	NR	10	37,52	242-335	6755013	NR	10	32,82	243-336
6669005	NR	01	30,10	333	6750007	NR	10	39,06	242-335	6755014	NR	10	59,36	243-336
6670001	NR	01	5,41	333	6750008	NR	10	84,36	242-335	6755015	NR	10	60,93	243-336
6670002	NR	01	6,73	333	6751001	NR	10	24,22	242-335	6755016	NR	10	70,87	243-336
6670003	NR	01	8,45	333	6751002	NR	10	25,00	242-335	6756001	NR	10	17,19	242-335
6670004	NR	01	16,63	333	6751003	NR	10	26,57	242-335	6756002	NR	10	18,76	242-335
6670005	NR	01	31,09	333	6751004	NR	10	29,29	242-335	6756003	NR	10	18,76	242-335

INDICE PER CODICE ARTICOLO

codice	UM	cat.	euro	pag.	codice	UM	cat.	euro	pag.	codice	UM	cat.	euro	pag.
6756004	NR	10	19,54	242-335	6771007	NR	01	54,05	325	6778001	NR	01	4,06	326
6756005	NR	10	21,08	242-335	6771008	NR	01	74,84	325	6778002	NR	01	5,81	326
6756006	NR	10	23,04	242-335	6772001	NR	01	5,12	325	6778003	NR	01	4,65	326
6756007	NR	10	25,00	242-335	6772002	NR	01	4,49	325	6778004	NR	01	4,92	326
6756008	NR	10	28,14	242-335	6772003	NR	01	5,71	325	6778005	NR	01	5,15	326
6756009	NR	10	38,84	242-335	6772004	NR	01	6,70	325	6778006	NR	01	11,95	326
6758001	NR	10	23,86	242-335	6772005	NR	01	19,04	325	6778007	NR	01	12,14	326
6758002	NR	10	27,86	242-335	6772006	NR	01	26,20	325	6778008	NR	01	12,57	326
6758003	NR	10	21,34	242-335	6772007	NR	01	41,75	325	6778009	NR	01	15,11	326
6758004	NR	10	26,26	242-335	6772008	NR	01	61,81	325	6778010	NR	01	16,01	326
6758005	NR	10	28,98	242-335	6773001	NR	01	6,47	325	6778011	NR	01	23,99	326
6758006	NR	10	37,16	242-335	6773002	NR	01	5,71	325	6778012	NR	01	23,43	326
6758007	NR	10	45,72	242-335	6773003	NR	01	6,30	325	6778013	NR	01	22,97	326
6758008	NR	10	51,02	242-335	6773004	NR	01	7,49	325	6778014	NR	01	31,48	326
6759001	NR	10	25,37	243-336	6773005	NR	01	20,43	325	6778015	NR	01	30,06	326
6759002	NR	10	33,74	243-336	6773006	NR	01	28,48	325	6779001	NR	01	5,15	326
6759003	NR	10	42,03	243-336	6773007	NR	01	45,08	325	6779002	NR	01	5,15	326
6759004	NR	10	49,59	243-336	6773008	NR	01	62,90	325	6779003	NR	01	6,24	326
6759005	NR	10	64,79	243-336	6774001	NR	01	12,74	325	6779004	NR	01	7,49	326
6763001	NR	10	19,54	243-336	6774002	NR	01	7,69	325	6779005	NR	01	13,30	326
6763002	NR	10	20,33	243-336	6774003	NR	01	9,90	325	6779006	NR	01	16,24	326
6763003	NR	10	22,65	243-336	6774004	NR	01	13,04	325	6779007	NR	01	28,28	326
6763004	NR	10	27,36	243-336	6774005	NR	01	21,55	325	6779008	NR	01	35,94	326
6763005	NR	10	31,25	243-336	6774006	NR	01	34,88	325	6780001	NR	01	11,95	326
6763006	NR	10	35,17	243-336	6774007	NR	01	66,13	325	6780002	NR	01	9,67	326
6763007	NR	10	39,06	243-336	6774008	NR	01	82,17	325	6780003	NR	01	12,18	326
6763008	NR	10	42,98	243-336	6775001	NR	01	22,47	326	6780004	NR	01	15,54	326
6763009	NR	10	48,83	243-336	6775002	NR	01	17,56	326	6780005	NR	01	23,40	326
6764001	NR	10	35,95	243-336	6775003	NR	01	10,40	326	6780006	NR	01	26,20	326
6764002	NR	10	38,28	243-336	6775004	NR	01	11,81	326	6780007	NR	01	39,20	326
6764003	NR	10	40,63	243-336	6775005	NR	01	13,00	326	6780008	NR	01	49,86	326
6764004	NR	10	43,76	243-336	6775006	NR	01	24,75	326	6790001	NR	01	20,82	327
6764005	NR	10	46,90	243-336	6775007	NR	01	32,01	326	6790002	NR	01	32,24	327
6764006	NR	10	49,22	243-336	6775008	NR	01	25,01	326	6790003	NR	01	32,37	327
6764007	NR	10	51,58	243-336	6775009	NR	01	40,99	326	6790004	NR	01	33,96	327
6764008	NR	10	56,25	243-336	6775010	NR	01	32,18	326	6790005	NR	01	50,03	327
6764009	NR	10	91,36	243-336	6775011	NR	01	34,06	326	6790006	NR	01	66,79	327
6766001	NR	10	18,93	243-336	6775012	NR	01	67,88	326	6790007	NR	01	92,83	327
6766002	NR	10	27,52	243-336	6775013	NR	01	60,32	326	6790008	NR	01	130,52	327
6770001	NR	01	5,18	325	6775014	NR	01	62,47	326	6791001	NR	01	17,00	327
6770002	NR	01	4,59	325	6775015	NR	01	86,46	326	6791002	NR	01	13,20	327
6770003	NR	01	5,84	325	6775016	NR	01	90,88	326	6791003	NR	01	28,64	327
6770004	NR	01	7,72	325	6775017	NR	01	78,47	326	6791004	NR	01	32,41	327
6770005	NR	01	16,67	325	6776001	NR	01	21,32	326	6791005	NR	01	33,99	327
6770006	NR	01	28,58	325	6776002	NR	01	18,81	326	6791006	NR	01	20,92	327
6770007	NR	01	56,30	325	6777001	NR	01	16,67	326	6791007	NR	01	32,67	327
6770008	NR	01	75,34	325	6777002	NR	01	18,38	326	6791008	NR	01	36,37	327
6771001	NR	01	5,78	325	6777003	NR	01	20,10	326	6791009	NR	01	61,71	327
6771002	NR	01	5,15	325	6777004	NR	01	20,49	326	6791010	NR	01	80,85	327
6771003	NR	01	6,40	325	6777005	NR	01	23,03	326	6791011	NR	01	126,65	327
6771004	NR	01	8,02	325	6777006	NR	01	32,37	326	6792001	NR	01	20,56	328
6771005	NR	01	15,81	325	6777007	NR	01	48,21	326	6792002	NR	01	34,35	328
6771006	NR	01	29,54	325	6777008	NR	01	52,50	326	6792003	NR	01	27,95	328

INDICE PER CODICE ARTICOLO

codice	UM	cat.	euro	pag.	codice	UM	cat.	euro	pag.	codice	UM	cat.	euro	pag.
6792004	NR	01	40,49	328	6802203	NR	10	47,88	273	6803602	NR	11	223,16	277
6792005	NR	01	35,31	328	6802204	NR	10	47,10	273	6803603	NR	11	247,95	277
6792006	NR	01	46,10	328	6802210	NR	10	59,05	274	6803604	NR	11	272,75	277
6792007	NR	01	49,63	328	6802211	NR	10	54,74	274	6803605	NR	11	295,08	277
6792008	NR	01	59,93	328	6802212	NR	10	47,88	274	6803606	NR	11	327,29	277
6792009	NR	01	85,14	328	6802213	NR	10	45,81	274	6803610	NR	11	173,57	278
6793001	NR	01	8,28	327	6802214	NR	10	45,00	274	6803611	NR	11	188,44	278
6793002	NR	01	5,05	327	6802400	NR	10	61,46	275	6803612	NR	11	223,16	278
6793003	NR	01	9,80	327	6802401	NR	10	57,46	275	6803613	NR	11	247,95	278
6793004	NR	01	6,53	327	6802402	NR	10	49,95	275	6803614	NR	11	272,75	278
6793005	NR	01	8,09	327	6802403	NR	10	47,88	275	6803615	NR	11	295,08	278
6793006	NR	01	10,59	327	6802404	NR	10	47,10	275	6803616	NR	11	327,29	278
6793007	NR	01	10,26	327	6802600	NR	11	115,71	277	6804000	NR	10	122,89	272
6793008	NR	01	12,51	327	6802601	NR	11	125,63	277	6804001	NR	10	114,91	272
6793009	NR	01	25,51	327	6802602	NR	11	148,77	277	6804002	NR	10	99,90	272
6793010	NR	01	16,27	327	6802603	NR	11	165,30	277	6804003	NR	10	95,76	272
6793011	NR	01	31,81	327	6802604	NR	11	181,83	277	6804004	NR	10	94,16	272
6793012	NR	01	35,90	327	6802605	NR	11	196,71	277	6804100	NR	10	114,27	276
6793013	NR	01	35,54	327	6802606	NR	11	218,20	277	6804101	NR	10	107,88	276
6793014	NR	01	49,90	327	6802610	NR	11	115,71	278	6804102	NR	10	94,16	276
6793015	NR	01	51,25	327	6802611	NR	11	125,63	278	6804103	NR	10	90,02	276
6793016	NR	01	95,30	327	6802612	NR	11	148,77	278	6804104	NR	10	88,42	276
6794001	NR	01	9,70	327	6802613	NR	11	165,30	278	6804200	NR	10	122,89	273
6794002	NR	01	6,47	327	6802614	NR	11	181,83	278	6804201	NR	10	114,91	273
6794003	NR	01	11,81	327	6802615	NR	11	196,71	278	6804202	NR	10	99,90	273
6794004	NR	01	8,25	327	6802616	NR	11	218,20	278	6804203	NR	10	95,76	273
6794005	NR	01	15,48	327	6803000	NR	10	92,18	272	6804204	NR	10	94,16	273
6794006	NR	01	9,77	327	6803001	NR	10	86,18	272	6804210	NR	10	118,10	274
6794007	NR	01	10,30	327	6803002	NR	10	74,93	272	6804211	NR	10	109,48	274
6794008	NR	01	14,52	327	6803003	NR	10	71,82	272	6804212	NR	10	95,76	274
6794009	NR	01	29,70	327	6803004	NR	10	70,62	272	6804213	NR	10	91,62	274
6794010	NR	01	17,52	327	6803100	NR	10	85,71	276	6804214	NR	10	90,02	274
6794011	NR	01	38,61	327	6803101	NR	10	80,92	276	6804400	NR	10	122,89	275
6794012	NR	01	38,84	327	6803102	NR	10	70,62	276	6804401	NR	10	114,91	275
6794013	NR	01	53,92	327	6803103	NR	10	67,51	276	6804402	NR	10	99,90	275
6794014	NR	01	57,45	327	6803104	NR	10	66,30	276	6804403	NR	10	95,76	275
6794015	NR	01	97,75	327	6803200	NR	10	92,18	273	6804404	NR	10	94,16	275
6795001	NR	01	14,42	328	6803201	NR	10	86,18	273	6804600	NR	11	231,42	277
6795002	NR	01	24,02	328	6803202	NR	10	74,93	273	6804601	NR	11	251,26	277
6795003	NR	01	40,16	328	6803203	NR	10	71,82	273	6804602	NR	11	297,54	277
6802000	NR	10	61,46	272	6803204	NR	10	70,62	273	6804603	NR	11	330,60	277
6802001	NR	10	57,46	272	6803210	NR	10	88,59	274	6804604	NR	11	363,66	277
6802002	NR	10	49,95	272	6803211	NR	10	82,12	274	6804605	NR	11	393,41	277
6802003	NR	10	47,88	272	6803212	NR	10	71,82	274	6804606	NR	11	436,39	277
6802004	NR	10	47,10	272	6803213	NR	10	68,71	274	6804610	NR	11	231,42	278
6802100	NR	10	57,15	276	6803214	NR	10	67,51	274	6804611	NR	11	251,26	278
6802101	NR	10	53,96	276	6803400	NR	10	92,18	275	6804612	NR	11	297,54	278
6802102	NR	10	47,10	276	6803401	NR	10	86,18	275	6804613	NR	11	330,60	278
6802103	NR	10	45,00	276	6803402	NR	10	74,93	275	6804614	NR	11	363,66	278
6802104	NR	10	44,21	276	6803403	NR	10	71,82	275	6804615	NR	11	393,41	278
6802200	NR	10	61,46	273	6803404	NR	10	70,62	275	6804616	NR	11	436,39	278
6802201	NR	10	57,46	273	6803600	NR	11	173,57	277	6805000	NR	10	153,61	272
6802202	NR	10	49,95	273	6803601	NR	11	188,44	277	6805001	NR	10	143,64	272

INDICE PER CODICE ARTICOLO

codice	UM	cat.	euro	pag.	codice	UM	cat.	euro	pag.	codice	UM	cat.	euro	pag.
6805002	NR	10	124,88	272	6806211	NR	10	164,22	274	6807605	NR	11	688,49	277
6805003	NR	10	119,70	272	6806212	NR	10	143,64	274	6807606	NR	11	763,69	277
6805004	NR	10	117,71	272	6806213	NR	10	137,42	274	6807610	NR	11	404,99	278
6805100	NR	10	142,86	276	6806214	NR	10	135,02	274	6807611	NR	11	439,70	278
6805101	NR	10	134,88	276	6806400	NR	10	184,35	275	6807612	NR	11	520,70	278
6805102	NR	10	117,71	276	6806401	NR	10	172,37	275	6807613	NR	11	578,55	278
6805103	NR	10	112,53	276	6806402	NR	10	149,86	275	6807614	NR	11	636,41	278
6805104	NR	10	110,52	276	6806403	NR	10	143,64	275	6807615	NR	11	688,49	278
6805200	NR	10	153,61	273	6806404	NR	10	141,26	275	6807616	NR	11	763,69	278
6805201	NR	10	143,64	273	6806600	NR	11	347,13	277	6808000	NR	10	245,78	272
6805202	NR	10	124,88	273	6806601	NR	11	376,88	277	6808001	NR	10	229,82	272
6805203	NR	10	119,70	273	6806602	NR	11	446,31	277	6808002	NR	10	199,81	272
6805204	NR	10	117,71	273	6806603	NR	11	495,90	277	6808003	NR	10	191,52	272
6805210	NR	10	147,64	274	6806604	NR	11	545,49	277	6808004	NR	10	188,33	272
6805211	NR	10	136,86	274	6806605	NR	11	590,12	277	6808100	NR	10	228,54	276
6805212	NR	10	119,70	274	6806606	NR	11	654,59	277	6808101	NR	10	215,77	276
6805213	NR	10	114,52	274	6806610	NR	11	347,13	278	6808102	NR	10	188,33	276
6805214	NR	10	112,53	274	6806611	NR	11	376,88	278	6808103	NR	10	180,04	276
6805400	NR	10	153,61	275	6806612	NR	11	446,31	278	6808104	NR	10	176,85	276
6805401	NR	10	143,64	275	6806613	NR	11	495,90	278	6808200	NR	10	245,78	273
6805402	NR	10	124,88	275	6806614	NR	11	545,49	278	6808201	NR	10	229,82	273
6805403	NR	10	119,70	275	6806615	NR	11	590,12	278	6808202	NR	10	199,81	273
6805404	NR	10	117,71	275	6806616	NR	11	654,59	278	6808203	NR	10	191,52	273
6805600	NR	11	289,28	277	6807000	NR	10	215,07	272	6808204	NR	10	188,33	273
6805601	NR	11	314,07	277	6807001	NR	10	201,10	272	6808210	NR	10	236,21	274
6805602	NR	11	371,93	277	6807002	NR	10	174,83	272	6808211	NR	10	218,96	274
6805603	NR	11	413,25	277	6807003	NR	10	167,58	272	6808212	NR	10	191,52	274
6805604	NR	11	454,58	277	6807004	NR	10	164,78	272	6808213	NR	10	183,23	274
6805605	NR	11	491,78	277	6807100	NR	10	199,98	276	6808214	NR	10	180,04	274
6805606	NR	11	545,49	277	6807101	NR	10	188,80	276	6808400	NR	10	245,78	275
6805610	NR	11	289,28	278	6807102	NR	10	164,78	276	6808401	NR	10	229,82	275
6805611	NR	11	314,07	278	6807103	NR	10	157,53	276	6808402	NR	10	199,81	275
6805612	NR	11	371,93	278	6807104	NR	10	154,73	276	6808403	NR	10	191,52	275
6805613	NR	11	413,25	278	6807200	NR	10	215,07	273	6808404	NR	10	188,33	275
6805614	NR	11	454,58	278	6807201	NR	10	201,10	273	6808600	NR	11	462,84	277
6805615	NR	11	491,78	278	6807202	NR	10	174,83	273	6808601	NR	11	502,51	277
6805616	NR	11	545,49	278	6807203	NR	10	167,58	273	6808602	NR	11	595,08	277
6806000	NR	10	184,35	272	6807204	NR	10	164,78	273	6808603	NR	11	661,20	277
6806001	NR	10	172,37	272	6807210	NR	10	206,70	274	6808604	NR	11	727,32	277
6806002	NR	10	149,86	272	6807211	NR	10	191,60	274	6808605	NR	11	786,83	277
6806003	NR	10	143,64	272	6807212	NR	10	167,58	274	6808606	NR	11	872,78	277
6806004	NR	10	141,26	272	6807213	NR	10	160,33	274	6808610	NR	11	462,84	278
6806100	NR	10	171,42	276	6807214	NR	10	157,53	274	6808611	NR	11	502,51	278
6806101	NR	10	161,84	276	6807400	NR	10	215,07	275	6808612	NR	11	595,08	278
6806102	NR	10	141,26	276	6807401	NR	10	201,10	275	6808613	NR	11	661,20	278
6806103	NR	10	135,02	276	6807402	NR	10	174,83	275	6808614	NR	11	727,32	278
6806104	NR	10	132,64	276	6807403	NR	10	167,58	275	6808615	NR	11	786,83	278
6806200	NR	10	184,35	273	6807404	NR	10	164,78	275	6808616	NR	11	872,78	278
6806201	NR	10	172,37	273	6807600	NR	11	404,99	277	6809000	NR	10	276,50	272
6806202	NR	10	149,86	273	6807601	NR	11	439,70	277	6809001	NR	10	258,55	272
6806203	NR	10	143,64	273	6807602	NR	11	520,70	277	6809002	NR	10	224,78	272
6806204	NR	10	141,26	273	6807603	NR	11	578,55	277	6809003	NR	10	215,46	272
6806210	NR	10	177,16	274	6807604	NR	11	636,41	277	6809004	NR	10	211,88	272

INDICE PER CODICE ARTICOLO

codice	UM	cat.	euro	pag.	codice	UM	cat.	euro	pag.	codice	UM	cat.	euro	pag.
6809100	NR	10	257,12	276	6811103	NR	10	247,55	276	6813214	NR	10	292,54	274
6809101	NR	10	242,76	276	6811104	NR	10	243,15	276	6813402	NR	10	324,72	275
6809102	NR	10	211,88	276	6811200	NR	10	337,96	273	6813403	NR	10	311,22	275
6809103	NR	10	202,52	276	6811201	NR	10	316,01	273	6813404	NR	10	306,04	275
6809104	NR	10	198,94	276	6811202	NR	10	274,76	273	6814002	NR	10	349,69	272
6809200	NR	10	276,50	273	6811203	NR	10	263,34	273	6814003	NR	10	335,16	272
6809201	NR	10	258,55	273	6811204	NR	10	258,94	273	6814004	NR	10	329,59	272
6809202	NR	10	224,78	273	6811210	NR	10	324,80	274	6814102	NR	10	329,59	276
6809203	NR	10	215,46	273	6811211	NR	10	301,08	274	6814103	NR	10	315,06	276
6809204	NR	10	211,88	273	6811212	NR	10	263,34	274	6814104	NR	10	309,46	276
6809210	NR	10	265,75	274	6811213	NR	10	251,92	274	6814202	NR	10	349,69	273
6809211	NR	10	246,34	274	6811214	NR	10	247,55	274	6814203	NR	10	335,16	273
6809212	NR	10	215,46	274	6811400	NR	10	337,96	275	6814204	NR	10	329,59	273
6809213	NR	10	206,14	274	6811401	NR	10	316,01	275	6814212	NR	10	335,16	274
6809214	NR	10	202,52	274	6811402	NR	10	274,76	275	6814213	NR	10	320,63	274
6809400	NR	10	276,50	275	6811403	NR	10	263,34	275	6814214	NR	10	315,06	274
6809401	NR	10	258,55	275	6811404	NR	10	258,94	275	6814402	NR	10	349,69	275
6809402	NR	10	224,78	275	6812000	NR	10	368,68	272	6814403	NR	10	335,16	275
6809403	NR	10	215,46	275	6812001	NR	10	344,74	272	6814404	NR	10	329,59	275
6809404	NR	10	211,88	275	6812002	NR	10	299,74	272	6850001	MT	06	1,91	354
6810000	NR	10	307,24	272	6812003	NR	10	287,28	272	6850002	MT	06	1,91	354
6810001	NR	10	287,28	272	6812004	NR	10	282,49	272	6904090	NR	10	399,00	271
6810002	NR	10	249,79	272	6812100	NR	10	342,83	276	6904100	NR	10	422,94	271
6810003	NR	10	239,40	272	6812101	NR	10	323,68	276	6904120	NR	10	437,30	271
6810004	NR	10	235,42	272	6812102	NR	10	282,49	276	6904140	NR	10	473,23	271
6810100	NR	10	285,68	276	6812103	NR	10	270,03	276	6904160	NR	10	528,28	271
6810101	NR	10	269,72	276	6812104	NR	10	265,24	276	6904173	NR	10	554,62	271
6810102	NR	10	235,42	276	6812200	NR	10	368,68	273	6904180	NR	10	557,00	271
6810103	NR	10	225,04	276	6812201	NR	10	344,74	273	6904200	NR	10	578,56	271
6810104	NR	10	221,06	276	6812202	NR	10	299,74	273	6905035	NR	10	319,20	270
6810200	NR	10	307,24	273	6812203	NR	10	287,28	273	6905050	NR	10	349,52	270
6810201	NR	10	287,28	273	6812204	NR	10	282,49	273	6905053	NR	10	363,10	270
6810202	NR	10	249,79	273	6812210	NR	10	354,31	274	6905060	NR	10	375,06	270
6810203	NR	10	239,40	273	6812211	NR	10	328,47	274	6905062	NR	10	383,04	270
6810204	NR	10	235,42	273	6812212	NR	10	287,28	274	6905070	NR	10	395,02	270
6810210	NR	10	295,26	274	6812213	NR	10	274,82	274	6905073	NR	10	406,98	271
6810211	NR	10	273,73	274	6812214	NR	10	270,03	274	6905080	NR	10	414,96	271
6810212	NR	10	239,40	274	6812400	NR	10	368,68	275	6905081	NR	10	438,90	271
6810213	NR	10	229,04	274	6812401	NR	10	344,74	275	6905090	NR	10	458,86	271
6810214	NR	10	225,04	274	6812402	NR	10	299,74	275	6905100	NR	10	491,57	271
6810400	NR	10	307,24	275	6812403	NR	10	287,28	275	6905120	NR	10	526,68	271
6810401	NR	10	287,28	275	6812404	NR	10	282,49	275	6905140	NR	10	571,37	271
6810402	NR	10	249,79	275	6813002	NR	10	324,72	272	6905160	NR	10	633,61	271
6810403	NR	10	239,40	275	6813003	NR	10	311,22	272	6905173	NR	10	664,75	271
6810404	NR	10	235,42	275	6813004	NR	10	306,04	272	6905180	NR	10	666,34	271
6811000	NR	10	337,96	272	6813102	NR	10	306,04	276	6905200	NR	10	706,24	271
6811001	NR	10	316,01	272	6813103	NR	10	292,54	276	6906035	NR	10	356,72	270
6811002	NR	10	274,76	272	6813104	NR	10	287,36	276	6906050	NR	10	397,40	270
6811003	NR	10	263,34	272	6813202	NR	10	324,72	273	6906053	NR	10	409,39	270
6811004	NR	10	258,94	272	6813203	NR	10	311,22	273	6906060	NR	10	424,54	270
6811100	NR	10	314,24	276	6813204	NR	10	306,04	273	6906062	NR	10	437,30	270
6811101	NR	10	296,69	276	6813212	NR	10	311,22	274	6906070	NR	10	452,48	270
6811102	NR	10	258,94	276	6813213	NR	10	297,72	274	6906073	NR	10	466,03	271

INDICE PER CODICE ARTICOLO

codice	UM	cat.	euro	pag.	codice	UM	cat.	euro	pag.	codice	UM	cat.	euro	pag.
6906080	NR	10	478,80	271	6909090	NR	10	746,14	271	6911080	NR	10	802,00	271
6906081	NR	10	502,74	271	6909100	NR	10	790,02	271	6911081	NR	10	841,90	271
6906090	NR	10	521,11	271	6909120	NR	10	869,82	271	6911090	NR	10	893,76	271
6906100	NR	10	563,39	271	6909140	NR	10	953,62	271	6911100	NR	10	945,64	271
6906120	NR	10	615,27	271	6909160	NR	10	1.037,40	271	6912004	NR	10	394,21	268
6906140	NR	10	670,32	271	6909173	NR	10	1.089,28	271	6912005	NR	10	492,38	268
6906160	NR	10	726,99	271	6909180	NR	10	1.117,20	271	6912006	NR	10	591,33	268
6906173	NR	10	762,89	271	6909200	NR	10	1.197,00	271	6912007	NR	10	689,47	268
6906180	NR	10	783,64	271	6910004	NR	10	348,74	268	6912008	NR	10	796,40	268
6906200	NR	10	841,90	271	6910005	NR	10	435,71	268	6912009	NR	10	887,38	268
6907035	NR	10	399,00	270	6910006	NR	10	522,70	268	6912010	NR	10	985,54	268
6907050	NR	10	448,48	270	6910007	NR	10	610,48	268	6912011	NR	10	1.083,68	268
6907053	NR	10	462,84	270	6910008	NR	10	697,45	268	6912012	NR	10	1.182,64	268
6907060	NR	10	478,80	270	6910009	NR	10	784,45	268	6912013	NR	10	1.280,80	268
6907062	NR	10	494,76	270	6910010	NR	10	871,42	268	6912014	NR	10	1.379,76	268
6907070	NR	10	512,32	270	6910011	NR	10	959,20	268	6912015	NR	10	1.477,90	268
6907073	NR	10	526,68	271	6910012	NR	10	1.046,19	268	6912016	NR	10	1.576,85	268
6907080	NR	10	542,64	271	6910013	NR	10	1.133,16	268	6912035	NR	10	624,04	270
6907081	NR	10	566,58	271	6910014	NR	10	1.220,94	268	6912050	NR	10	701,46	270
6907090	NR	10	598,50	271	6910015	NR	10	1.307,12	268	6912053	NR	10	722,20	270
6907100	NR	10	638,40	271	6910016	NR	10	1.394,90	268	6912060	NR	10	754,12	270
6907120	NR	10	706,24	271	6910017	NR	10	1.481,90	268	6912062	NR	10	776,47	270
6907140	NR	10	766,08	271	6910018	NR	10	1.568,87	268	6912070	NR	10	813,96	270
6907160	NR	10	829,92	271	6910019	NR	10	1.656,65	268	6912073	NR	10	837,90	271
6907173	NR	10	873,82	271	6910020	NR	10	1.743,64	268	6912080	NR	10	862,65	271
6907180	NR	10	897,76	271	6910021	NR	10	1.830,61	268	6912081	NR	10	905,74	271
6907200	NR	10	961,60	271	6910022	NR	10	1.917,61	268	6912090	NR	10	961,60	271
6908035	NR	10	442,90	270	6910023	NR	10	2.005,39	268	6912100	NR	10	1.018,25	271
6908050	NR	10	497,17	270	6910024	NR	10	2.092,36	268	6913035	NR	10	670,32	270
6908053	NR	10	512,32	270	6910035	NR	10	533,06	270	6913050	NR	10	754,12	270
6908060	NR	10	533,88	270	6910050	NR	10	601,69	270	6913053	NR	10	774,06	270
6908062	NR	10	549,84	270	6910053	NR	10	620,06	270	6913060	NR	10	813,96	270
6908070	NR	10	569,77	270	6910060	NR	10	644,78	270	6913062	NR	10	833,92	270
6908073	NR	10	586,54	271	6910062	NR	10	663,94	270	6913070	NR	10	873,82	270
6908080	NR	10	601,69	271	6910070	NR	10	691,88	270	6913073	NR	10	897,76	271
6908081	NR	10	632,02	271	6910073	NR	10	712,63	271	6913080	NR	10	929,68	271
6908090	NR	10	670,32	271	6910080	NR	10	735,76	271	6913081	NR	10	973,56	271
6908100	NR	10	714,22	271	6910081	NR	10	772,46	271	6913090	NR	10	1.033,42	271
6908120	NR	10	783,64	271	6910090	NR	10	821,16	271	6913100	NR	10	1.093,26	271
6908140	NR	10	862,65	271	6910100	NR	10	868,22	271	6914004	NR	10	436,52	268
6908160	NR	10	933,66	271	6910120	NR	10	952,81	271	6914005	NR	10	545,83	268
6908173	NR	10	979,94	271	6910140	NR	10	1.046,98	271	6914006	NR	10	654,36	268
6908180	NR	10	1.005,48	271	6910160	NR	10	1.139,54	271	6914007	NR	10	764,48	268
6908200	NR	10	1.077,30	271	6910173	NR	10	1.195,40	271	6914008	NR	10	873,01	268
6909035	NR	10	486,78	270	6910180	NR	10	1.227,32	271	6914009	NR	10	981,54	268
6909050	NR	10	550,62	270	6910200	NR	10	1.315,92	271	6914010	NR	10	1.091,66	268
6909053	NR	10	566,58	270	6911035	NR	10	578,56	270	6914011	NR	10	1.201,00	268
6909060	NR	10	590,52	270	6911050	NR	10	652,76	270	6914012	NR	10	1.310,32	268
6909062	NR	10	606,48	270	6911053	NR	10	674,32	270	6914013	NR	10	1.418,84	268
6909070	NR	10	630,42	270	6911060	NR	10	702,24	270	6914014	NR	10	1.528,18	268
6909073	NR	10	650,38	271	6911062	NR	10	722,20	270	6914015	NR	10	1.637,50	268
6909080	NR	10	670,32	271	6911070	NR	10	754,12	270	6914016	NR	10	1.746,02	268
6909081	NR	10	702,24	271	6911073	NR	10	778,06	271	6914035	NR	10	714,22	270

INDICE PER CODICE ARTICOLO

codice	UM	cat.	euro	pag.	codice	UM	cat.	euro	pag.	codice	UM	cat.	euro	pag.
6914050	NR	10	804,38	270	6920008	NR	10	1.128,37	269	6941208	NR	10	796,40	264
6914053	NR	10	828,32	270	6920009	NR	10	1.268,82	269	6941209	NR	10	887,38	264
6914060	NR	10	868,22	270	6920010	NR	10	1.410,08	269	6941210	NR	10	985,54	264
6914062	NR	10	893,76	270	6920011	NR	10	1.551,31	269	6941211	NR	10	1.083,68	264
6914070	NR	10	932,06	270	6920012	NR	10	1.691,76	269	6941212	NR	10	1.182,64	264
6914073	NR	10	957,60	271	6920013	NR	10	1.833,02	269	6941213	NR	10	1.280,80	264
6914080	NR	10	995,12	271	6920014	NR	10	1.974,25	269	6941214	NR	10	1.379,76	264
6914081	NR	10	1.045,38	271	6920015	NR	10	2.114,70	269	6941215	NR	10	1.477,90	264
6914090	NR	10	1.102,84	271	6920016	NR	10	2.255,96	269	6941216	NR	10	1.576,85	264
6914100	NR	10	1.169,08	271	6935006	NR	10	291,28	266	6941404	NR	10	436,52	264
6916004	NR	10	474,82	268	6935007	NR	10	339,16	266	6941405	NR	10	545,83	264
6916005	NR	10	593,71	268	6935008	NR	10	387,83	266	6941406	NR	10	654,36	264
6916006	NR	10	712,63	268	6935009	NR	10	436,52	266	6941407	NR	10	764,48	264
6916007	NR	10	831,52	268	6935010	NR	10	485,18	266	6941408	NR	10	873,01	264
6916008	NR	10	949,62	268	6935011	NR	10	533,06	266	6941409	NR	10	981,54	264
6916009	NR	10	1.068,54	268	6935012	NR	10	582,54	266	6941410	NR	10	1.091,66	264
6916010	NR	10	1.187,42	268	6935013	NR	10	630,42	266	6941411	NR	10	1.201,00	264
6916011	NR	10	1.306,34	268	6935014	NR	10	679,11	266	6941412	NR	10	1.310,32	264
6916012	NR	10	1.425,23	268	6935015	NR	10	727,78	266	6941413	NR	10	1.418,84	264
6916013	NR	10	1.543,33	268	6935016	NR	10	776,47	266	6941414	NR	10	1.528,18	264
6916014	NR	10	1.662,25	268	6935017	NR	10	825,13	266	6941415	NR	10	1.637,50	264
6916015	NR	10	1.781,14	268	6935018	NR	10	873,01	266	6941416	NR	10	1.746,02	264
6916016	NR	10	1.899,24	268	6935019	NR	10	921,70	266	6941604	NR	10	474,82	264
6917304	NR	10	521,89	269	6935020	NR	10	970,37	266	6941605	NR	10	593,71	264
6917305	NR	10	651,98	269	6935021	NR	10	1.019,06	266	6941606	NR	10	712,63	264
6917306	NR	10	782,04	269	6935022	NR	10	1.067,72	266	6941607	NR	10	831,52	264
6917307	NR	10	912,91	269	6935023	NR	10	1.115,60	266	6941608	NR	10	949,62	264
6917308	NR	10	1.043,00	269	6935024	NR	10	1.165,08	266	6941609	NR	10	1.068,54	264
6917309	NR	10	1.173,06	269	6941004	NR	10	348,74	264	6941610	NR	10	1.187,42	264
6917310	NR	10	1.303,93	269	6941005	NR	10	435,71	264	6941611	NR	10	1.306,34	264
6917311	NR	10	1.434,02	269	6941006	NR	10	522,70	264	6941612	NR	10	1.425,23	264
6917312	NR	10	1.564,08	269	6941007	NR	10	610,48	264	6941613	NR	10	1.543,33	264
6917313	NR	10	1.694,95	269	6941008	NR	10	697,45	264	6941614	NR	10	1.662,25	264
6917314	NR	10	1.825,82	269	6941009	NR	10	784,45	264	6941615	NR	10	1.781,14	264
6917315	NR	10	1.955,10	269	6941010	NR	10	871,42	264	6941616	NR	10	1.899,24	264
6917316	NR	10	2.085,97	269	6941011	NR	10	959,20	264	6941704	NR	10	521,89	265
6918004	NR	10	534,66	269	6941012	NR	10	1.046,19	264	6941705	NR	10	651,98	265
6918005	NR	10	667,94	269	6941013	NR	10	1.133,16	264	6941706	NR	10	782,04	265
6918006	NR	10	801,19	269	6941014	NR	10	1.220,94	264	6941707	NR	10	912,91	265
6918007	NR	10	935,26	269	6941015	NR	10	1.307,12	264	6941708	NR	10	1.043,00	265
6918008	NR	10	1.068,54	269	6941016	NR	10	1.394,90	264	6941709	NR	10	1.173,06	265
6918009	NR	10	1.202,60	269	6941017	NR	10	1.481,90	264	6941710	NR	10	1.303,93	265
6918010	NR	10	1.335,85	269	6941018	NR	10	1.568,87	264	6941711	NR	10	1.434,02	265
6918011	NR	10	1.469,13	269	6941019	NR	10	1.656,65	264	6941712	NR	10	1.564,08	265
6918012	NR	10	1.603,20	269	6941020	NR	10	1.743,64	264	6941713	NR	10	1.694,95	265
6918013	NR	10	1.736,45	269	6941021	NR	10	1.830,61	264	6941714	NR	10	1.825,82	265
6918014	NR	10	1.870,51	269	6941022	NR	10	1.917,61	264	6941715	NR	10	1.955,10	265
6918015	NR	10	2.003,79	269	6941023	NR	10	2.005,39	264	6941716	NR	10	2.085,97	265
6918016	NR	10	2.137,04	269	6941024	NR	10	2.092,36	264	6941804	NR	10	534,66	265
6920004	NR	10	564,20	269	6941204	NR	10	394,21	264	6941805	NR	10	667,94	265
6920005	NR	10	704,65	269	6941205	NR	10	492,38	264	6941806	NR	10	801,19	265
6920006	NR	10	845,88	269	6941206	NR	10	591,33	264	6941807	NR	10	935,26	265
6920007	NR	10	987,14	269	6941207	NR	10	689,47	264	6941808	NR	10	1.068,54	265

INDICE PER CODICE ARTICOLO

codice	UM	cat.	euro	pag.	codice	UM	cat.	euro	pag.	codice	UM	cat.	euro	pag.
6941809	NR	10	1.202,60	265	6945019	NR	10	1.079,71	262	6946215	NR	10	955,22	263
6941810	NR	10	1.335,85	265	6945020	NR	10	1.137,16	262	6946216	NR	10	1.019,06	263
6941811	NR	10	1.469,13	265	6945021	NR	10	1.193,81	262	6946217	NR	10	1.082,90	263
6941812	NR	10	1.603,20	265	6945022	NR	10	1.250,48	262	6946218	NR	10	1.145,93	263
6941813	NR	10	1.736,45	265	6945023	NR	10	1.307,94	262	6946219	NR	10	1.209,77	263
6941814	NR	10	1.870,51	265	6945024	NR	10	1.364,58	262	6946220	NR	10	1.273,61	263
6941815	NR	10	2.003,79	265	6945306	NR	10	355,12	262	6946221	NR	10	1.336,66	263
6941816	NR	10	2.137,04	265	6945307	NR	10	413,36	262	6946222	NR	10	1.401,29	263
6942004	NR	10	564,20	265	6945308	NR	10	473,23	262	6946223	NR	10	1.464,34	263
6942005	NR	10	704,65	265	6945309	NR	10	532,28	262	6946224	NR	10	1.528,18	263
6942006	NR	10	845,88	265	6945310	NR	10	591,33	262	6947006	NR	10	400,60	263
6942007	NR	10	987,14	265	6945311	NR	10	650,38	262	6947007	NR	10	466,84	263
6942008	NR	10	1.128,37	265	6945312	NR	10	709,44	262	6947008	NR	10	533,88	263
6942009	NR	10	1.268,82	265	6945313	NR	10	768,49	262	6947009	NR	10	600,10	263
6942010	NR	10	1.410,08	265	6945314	NR	10	827,54	262	6947010	NR	10	667,13	263
6942011	NR	10	1.551,31	265	6945315	NR	10	887,38	262	6947011	NR	10	734,16	263
6942012	NR	10	1.691,76	265	6945316	NR	10	945,64	262	6947012	NR	10	800,41	263
6942013	NR	10	1.833,02	265	6945317	NR	10	1.005,48	262	6947013	NR	10	867,44	263
6942014	NR	10	1.974,25	265	6945318	NR	10	1.064,53	262	6947014	NR	10	933,66	263
6942015	NR	10	2.114,70	265	6945319	NR	10	1.123,58	262	6947015	NR	10	1.000,69	263
6942016	NR	10	2.255,96	265	6945320	NR	10	1.182,64	262	6947016	NR	10	1.067,72	263
6943506	NR	10	291,28	262	6945321	NR	10	1.241,69	262	6947017	NR	10	1.133,97	263
6943507	NR	10	339,16	262	6945322	NR	10	1.300,74	262	6947018	NR	10	1.201,00	263
6943508	NR	10	387,83	262	6945323	NR	10	1.359,79	262	6947019	NR	10	1.267,22	263
6943509	NR	10	436,52	262	6945324	NR	10	1.418,84	262	6947020	NR	10	1.334,26	263
6943510	NR	10	485,18	262	6946006	NR	10	364,70	262	6947021	NR	10	1.401,29	263
6943511	NR	10	533,06	262	6946007	NR	10	426,13	262	6947022	NR	10	1.467,54	263
6943512	NR	10	582,54	262	6946008	NR	10	486,78	262	6947023	NR	10	1.534,57	263
6943513	NR	10	630,42	262	6946009	NR	10	547,43	262	6947024	NR	10	1.600,79	263
6943514	NR	10	679,11	262	6946010	NR	10	608,89	262	6947306	NR	10	409,39	263
6943515	NR	10	727,78	262	6946011	NR	10	669,54	262	6947307	NR	10	477,20	263
6943516	NR	10	776,47	262	6946012	NR	10	730,18	262	6947308	NR	10	545,83	263
6943517	NR	10	825,13	262	6946013	NR	10	790,83	262	6947309	NR	10	614,46	263
6943518	NR	10	873,01	262	6946014	NR	10	852,26	262	6947310	NR	10	682,30	263
6943519	NR	10	921,70	262	6946015	NR	10	912,91	262	6947311	NR	10	750,12	263
6943520	NR	10	970,37	262	6946016	NR	10	973,56	262	6947312	NR	10	818,75	263
6943521	NR	10	1.019,06	262	6946017	NR	10	1.034,21	262	6947313	NR	10	887,38	263
6943522	NR	10	1.067,72	262	6946018	NR	10	1.095,67	262	6947314	NR	10	955,22	263
6943523	NR	10	1.115,60	262	6946019	NR	10	1.156,32	262	6947315	NR	10	1.023,04	263
6943524	NR	10	1.165,08	262	6946020	NR	10	1.216,96	262	6947316	NR	10	1.091,66	263
6945006	NR	10	340,76	262	6946021	NR	10	1.277,61	262	6947317	NR	10	1.160,29	263
6945007	NR	10	397,40	262	6946022	NR	10	1.399,69	262	6947318	NR	10	1.228,14	263
6945008	NR	10	454,86	262	6946023	NR	10	1.418,84	262	6947319	NR	10	1.296,76	263
6945009	NR	10	511,53	262	6946024	NR	10	1.460,34	262	6947320	NR	10	1.364,58	263
6945010	NR	10	568,18	262	6946206	NR	10	382,26	263	6947321	NR	10	1.432,42	263
6945011	NR	10	624,85	262	6946207	NR	10	445,28	263	6947322	NR	10	1.501,05	263
6945012	NR	10	682,30	262	6946208	NR	10	509,12	263	6947323	NR	10	1.568,87	263
6945013	NR	10	738,95	262	6946209	NR	10	572,96	263	6947324	NR	10	1.637,50	263
6945014	NR	10	795,62	262	6946210	NR	10	636,80	263	6948006	NR	10	422,94	263
6945015	NR	10	852,26	262	6946211	NR	10	700,64	263	6948007	NR	10	493,16	263
6945016	NR	10	909,72	262	6946212	NR	10	764,48	263	6948008	NR	10	564,20	263
6945017	NR	10	966,39	262	6946213	NR	10	827,54	263	6948009	NR	10	634,42	263
6945018	NR	10	1.023,04	262	6946214	NR	10	891,38	263	6948010	NR	10	704,65	263

INDICE PER CODICE ARTICOLO

codice	UM	cat.	euro	pag.	codice	UM	cat.	euro	pag.	codice	UM	cat.	euro	pag.
6948011	NR	10	775,66	263	6949024	NR	10	1.910,41	263	6960020	NR	10	1.216,96	266
6948012	NR	10	845,88	263	6950006	NR	10	340,76	266	6960021	NR	10	1.277,61	266
6948013	NR	10	916,10	263	6950007	NR	10	397,40	266	6960022	NR	10	1.399,69	266
6948014	NR	10	987,14	263	6950008	NR	10	454,86	266	6960023	NR	10	1.418,84	266
6948015	NR	10	1.057,36	263	6950009	NR	10	511,53	266	6960024	NR	10	1.460,34	266
6948016	NR	10	1.128,37	263	6950010	NR	10	568,18	266	6962306	NR	10	382,26	267
6948017	NR	10	1.198,60	263	6950011	NR	10	624,85	266	6962307	NR	10	445,28	267
6948018	NR	10	1.268,82	263	6950012	NR	10	682,30	266	6962308	NR	10	509,12	267
6948019	NR	10	1.339,04	263	6950013	NR	10	738,95	266	6962309	NR	10	572,96	267
6948020	NR	10	1.410,08	263	6950014	NR	10	795,62	266	6962310	NR	10	636,80	267
6948021	NR	10	1.480,30	263	6950015	NR	10	852,26	266	6962311	NR	10	700,64	267
6948022	NR	10	1.551,31	263	6950016	NR	10	909,72	266	6962312	NR	10	764,48	267
6948023	NR	10	1.621,54	263	6950017	NR	10	966,39	266	6962313	NR	10	827,54	267
6948024	NR	10	1.691,76	263	6950018	NR	10	1.023,04	266	6962314	NR	10	891,38	267
6948106	NR	10	441,31	263	6950019	NR	10	1.079,71	266	6962315	NR	10	955,22	267
6948107	NR	10	514,72	263	6950020	NR	10	1.137,16	266	6962316	NR	10	1.019,06	267
6948108	NR	10	588,14	263	6950021	NR	10	1.193,81	266	6962317	NR	10	1.082,90	267
6948109	NR	10	661,56	263	6950022	NR	10	1.250,48	266	6962318	NR	10	1.145,93	267
6948110	NR	10	734,97	263	6950023	NR	10	1.307,94	266	6962319	NR	10	1.209,77	267
6948111	NR	10	809,17	263	6950024	NR	10	1.364,58	266	6962320	NR	10	1.273,61	267
6948112	NR	10	881,80	263	6953006	NR	10	355,12	266	6962321	NR	10	1.336,66	267
6948113	NR	10	956,00	263	6953007	NR	10	413,36	266	6962322	NR	10	1.401,29	267
6948114	NR	10	1.029,42	263	6953008	NR	10	473,23	266	6962323	NR	10	1.464,34	267
6948115	NR	10	1.102,84	263	6953009	NR	10	532,28	266	6962324	NR	10	1.528,18	267
6948116	NR	10	1.176,25	263	6953010	NR	10	591,33	266	6970006	NR	10	400,60	267
6948117	NR	10	1.249,67	263	6953011	NR	10	650,38	266	6970007	NR	10	466,84	267
6948118	NR	10	1.323,08	263	6953012	NR	10	709,44	266	6970008	NR	10	533,88	267
6948119	NR	10	1.396,50	263	6953013	NR	10	768,49	266	6970009	NR	10	600,10	267
6948120	NR	10	1.470,73	263	6953014	NR	10	827,54	266	6970010	NR	10	667,13	267
6948121	NR	10	1.544,14	263	6953015	NR	10	887,38	266	6970011	NR	10	734,16	267
6948122	NR	10	1.617,56	263	6953016	NR	10	945,64	266	6970012	NR	10	800,41	267
6948123	NR	10	1.691,76	263	6953017	NR	10	1.005,48	266	6970013	NR	10	867,44	267
6948124	NR	10	1.765,18	263	6953018	NR	10	1.064,53	266	6970014	NR	10	933,66	267
6949004	NR	10	318,42	263	6953019	NR	10	1.123,58	266	6970015	NR	10	1.000,69	267
6949005	NR	10	398,22	263	6953020	NR	10	1.182,64	266	6970016	NR	10	1.067,72	267
6949006	NR	10	478,02	263	6953021	NR	10	1.241,69	266	6970017	NR	10	1.133,97	267
6949007	NR	10	557,00	263	6953022	NR	10	1.300,74	266	6970018	NR	10	1.201,00	267
6949008	NR	10	636,80	263	6953023	NR	10	1.359,79	266	6970019	NR	10	1.267,22	267
6949009	NR	10	716,60	263	6953024	NR	10	1.418,84	266	6970020	NR	10	1.334,26	267
6949010	NR	10	796,40	263	6960006	NR	10	364,70	266	6970021	NR	10	1.401,29	267
6949011	NR	10	875,42	263	6960007	NR	10	426,13	266	6970022	NR	10	1.467,54	267
6949012	NR	10	955,22	263	6960008	NR	10	486,78	266	6970023	NR	10	1.534,57	267
6949013	NR	10	1.035,02	263	6960009	NR	10	547,43	266	6970024	NR	10	1.600,79	267
6949014	NR	10	1.114,82	263	6960010	NR	10	608,89	266	6973006	NR	10	409,39	267
6949015	NR	10	1.193,81	263	6960011	NR	10	669,54	266	6973007	NR	10	477,20	267
6949016	NR	10	1.273,61	263	6960012	NR	10	730,18	266	6973008	NR	10	545,83	267
6949017	NR	10	1.353,41	263	6960013	NR	10	790,83	266	6973009	NR	10	614,46	267
6949018	NR	10	1.432,42	263	6960014	NR	10	852,26	266	6973010	NR	10	682,30	267
6949019	NR	10	1.512,22	263	6960015	NR	10	912,91	266	6973011	NR	10	750,12	267
6949020	NR	10	1.592,02	263	6960016	NR	10	973,56	266	6973012	NR	10	818,75	267
6949021	NR	10	1.671,82	263	6960017	NR	10	1.034,21	266	6973013	NR	10	887,38	267
6949022	NR	10	1.750,81	263	6960018	NR	10	1.095,67	266	6973014	NR	10	955,22	267
6949023	NR	10	1.830,61	263	6960019	NR	10	1.156,32	266	6973015	NR	10	1.023,04	267

INDICE PER CODICE ARTICOLO

codice	UM	cat.	euro	pag.	codice	UM	cat.	euro	pag.	codice	UM	cat.	euro	pag.
6973016	NR	10	1.091,66	267	6990010	NR	10	796,40	267	9090480	MT	18	2,93	350
6973017	NR	10	1.160,29	267	6990011	NR	10	875,42	267	9090540	MT	18	3,84	350
6973018	NR	10	1.228,14	267	6990012	NR	10	955,22	267	9090600	MT	18	4,03	350
6973019	NR	10	1.296,76	267	6990013	NR	10	1.035,02	267	9090760	MT	18	5,28	350
6973020	NR	10	1.364,58	267	6990014	NR	10	1.114,82	267	9090890	MT	18	6,62	350
6973021	NR	10	1.432,42	267	6990015	NR	10	1.193,81	267	9091140	MT	18	10,75	350
6973022	NR	10	1.501,05	267	6990016	NR	10	1.273,61	267	9130120	MT	18	1,78	350
6973023	NR	10	1.568,87	267	6990017	NR	10	1.353,41	267	9130150	MT	18	2,02	350
6973024	NR	10	1.637,50	267	6990018	NR	10	1.432,42	267	9130180	MT	18	2,11	350
6980006	NR	10	422,94	267	6990019	NR	10	1.512,22	267	9130220	MT	18	2,11	350
6980007	NR	10	493,16	267	6990020	NR	10	1.592,02	267	9130250	MT	18	2,40	350
6980008	NR	10	564,20	267	6990021	NR	10	1.671,82	267	9130280	MT	18	2,59	350
6980009	NR	10	634,42	267	6990022	NR	10	1.750,81	267	9130350	MT	18	3,02	350
6980010	NR	10	704,65	267	6990023	NR	10	1.830,61	267	9130420	MT	18	3,55	350
6980011	NR	10	775,66	267	6990024	NR	10	1.910,41	267	9130480	MT	18	4,03	350
6980012	NR	10	845,88	267	800102101075	MQ	18	17,28	351	9130540	MT	18	4,99	350
6980013	NR	10	916,10	267	800132101075	MQ	18	21,22	351	9130600	MT	18	5,33	350
6980014	NR	10	987,14	267	800192101075	MQ	18	30,00	351	9130640	MT	18	6,24	350
6980015	NR	10	1.057,36	267	800252101075	MQ	18	38,93	351	9130760	MT	18	6,67	350
6980016	NR	10	1.128,37	267	800322101075	MQ	18	39,89	351	9130890	MT	18	8,35	350
6980017	NR	10	1.198,60	267	850VR020444	NR	02	7.155,78	349	9131140	MT	18	13,25	350
6980018	NR	10	1.268,82	267	850VR0204501	NR	02	16,46	349	9131250	MT	18	19,63	350
6980019	NR	10	1.339,04	267	850VR0204511	NR	02	19,48	349	9169010	MT	07	31,12	348
6980020	NR	10	1.410,08	267	850VR0204521	NR	02	24,48	349	9169015	MT	07	31,12	348
6980021	NR	10	1.480,30	267	850VR0204531	NR	02	26,15	349	9169020	MT	07	31,12	348
6980022	NR	10	1.551,31	267	850VR0204541	NR	02	30,43	349	9169025	MT	07	31,12	348
6980023	NR	10	1.621,54	267	850VR0204551	NR	02	15,88	349	9169050	MT	07	31,12	348
6980024	NR	10	1.691,76	267	850VR0204561	NR	02	18,80	349	9169100	MT	07	31,12	348
6981306	NR	10	441,31	267	850VR0204571	NR	02	23,66	349	9169150	MT	07	31,12	348
6981307	NR	10	514,72	267	850VR0204581	NR	02	26,11	349	9190150	MT	18	3,79	350
6981308	NR	10	588,14	267	850VR0204651	NR	02	25,70	349	9190180	MT	18	4,27	350
6981309	NR	10	661,56	267	850VR0204661	NR	02	35,16	349	9190200	MT	18	4,51	350
6981310	NR	10	734,97	267	850VR0204671	NR	02	40,60	349	9190220	MT	18	4,61	350
6981311	NR	10	809,17	267	850VR020471	NR	02	3.213,51	349	9190250	MT	18	5,09	350
6981312	NR	10	881,80	267	9060120	MT	18	1,01	350	9190280	MT	18	5,33	350
6981313	NR	10	956,00	267	9060150	MT	18	1,06	350	9190320	MT	18	6,29	350
6981314	NR	10	1.029,42	267	9060180	MT	18	1,10	350	9190350	MT	18	6,62	350
6981315	NR	10	1.102,84	267	9060200	MT	18	1,15	350	9190420	MT	18	8,02	350
6981316	NR	10	1.176,25	267	9060220	MT	18	1,30	350	9190480	MT	18	8,98	350
6981317	NR	10	1.249,67	267	9060250	MT	18	1,49	350	9190540	MT	18	10,08	351
6981318	NR	10	1.323,08	267	9060280	MT	18	1,54	350	9190600	MT	18	11,04	351
6981319	NR	10	1.396,50	267	9060350	MT	18	2,06	350	9190640	MT	18	12,05	351
6981320	NR	10	1.470,73	267	9060420	MT	18	2,30	350	9190760	MT	18	13,97	351
6981321	NR	10	1.544,14	267	9090100	MT	18	1,15	350	9190890	MT	18	15,26	351
6981322	NR	10	1.617,56	267	9090120	MT	18	1,25	350	9191140	MT	18	22,61	351
6981323	NR	10	1.691,76	267	9090150	MT	18	1,34	350	9191250	MT	18	30,14	351
6981324	NR	10	1.765,18	267	9090180	MT	18	1,49	350	9209010	MT	07	34,76	348
6990004	NR	10	318,42	267	9090200	MT	18	1,49	350	9209015	MT	07	34,76	348
6990005	NR	10	398,22	267	9090220	MT	18	1,49	350	9209020	MT	07	34,76	348
6990006	NR	10	478,02	267	9090250	MT	18	2,02	350	9209025	MT	07	34,76	348
6990007	NR	10	557,00	267	9090280	MT	18	2,11	350	9209050	MT	07	34,76	348
6990008	NR	10	636,80	267	9090350	MT	18	2,30	350	9209100	MT	07	34,76	348
6990009	NR	10	716,60	267	9090420	MT	18	2,59	350	9209150	MT	07	34,76	348

INDICE PER CODICE ARTICOLO

codice	UM	cat.	euro	pag.	codice	UM	cat.	euro	pag.	codice	UM	cat.	euro	pag.
9250220	MT	18	8,30	351	PNC401140	NR	09	78,64	355					
9250280	MT	18	9,46	351										
9250350	MT	18	11,62	351										
9250420	MT	18	12,82	351										
9250480	MT	18	14,50	351										
9250540	MT	18	15,79	351										
9250600	MT	18	15,84	351										
9250760	MT	18	24,86	351										
9250890	MT	18	27,50	351										
9251140	MT	18	39,65	351										
9259025	MT	07	44,42	348										
9259050	MT	07	44,42	348										
9259100	MT	07	44,42	348										
9310002	MT	09	2,84	352										
9310004	MT	09	4,16	352										
9310006	MT	09	4,96	352										
9310007	MT	09	5,16	352										
9310008	MT	09	5,24	352										
9310009	MT	09	6,40	352										
9320280	MT	18	14,98	351										
9320350	MT	18	16,90	351										
9320420	MT	18	19,68	351										
9320480	MT	18	21,74	351										
9320540	MT	18	25,06	351										
9320600	MT	18	26,98	351										
9320640	MT	18	28,56	351										
9320760	MT	18	32,69	351										
9320890	MT	18	37,68	351										
9321140	MT	18	54,00	351										
9400420	MT	18	40,85	351										
9400480	MT	18	44,93	351										
9400540	MT	18	49,06	351										
9500890	MT	18	106,70	351										
9601140	MT	18	131,86	351										
9950600	MT	18	81,65	351										
9950760	MT	18	99,17	351										
PN0200220	MT	09	16,52	355										
PN0200270	MT	09	17,08	355										
PN0200340	MT	09	19,92	355										
PN0200420	MT	09	22,48	355										
PN0250480	MT	09	26,08	355										
PN0250600	MT	09	28,76	355										
PN0300760	MT	09	38,16	355										
PN0300880	MT	09	45,00	355										
PN0401140	MT	09	60,52	355										
PNC200220	NR	09	20,28	355										
PNC200270	NR	09	22,76	355										
PNC200340	NR	09	23,80	355										
PNC200420	NR	09	24,96	355										
PNC250480	NR	09	29,76	355										
PNC250600	NR	09	35,72	355										
PNC300760	NR	09	46,60	355										
PNC300880	NR	09	53,12	355										

ASSOCIATI GRUPPO DELFINO

alfani
CERAMICHE

Borgotermica

andreatto

IDROMARKET
TERMOSANTARIA ARREDOBAGNO CERAMICHE

TERMOSABINA

Lorenzo Ottogalli

PANTERMO
ARTICOLI IDROTERMOSANTARI

IDRO - COMM.

CITAB

CLARK s.r.l.

S.I.R.E.A.
di REPETTO A. & C. s.r.l.
DAL 1921
BAGNO - PIASTRELLE - RISCALDAMENTO - CONDIZIONAMENTO

ISAF
LINEA BAGNO
IL BAGNO CHE RIDE

ciesse
dal 1969 SOLUZIONI TERMOIDRAULICHE

IDROTERMOSANTARI
Di Monte
il clima ideale

EP
EREDI PIANTONI

E dilceramica
ugubina

EDILNORDUE TERMCO

Montagna
dal 1930

FATIS

LA SANITARIA PAVESE

IL PIACERE
DI FARSI UN BEL BAGNO

BONCI
Soluzioni per l'Abitare

EURO
OTIR S.R.L.
Famiglia Liberati, idraulici dal 1970.

Vires

CENTRO TERMOIDRAULICO
Leuzzi

VALLATI
elementi per abitare

Risab
forniture termoidrauliche

IDROPLAST

Termoidraulica
di Roberto Pusceddu

SPAM
di Sansaro C & C sas

delfino

www.deloitalia.com

DELO

ASSOCIATI GRUPPO DELFINO

TECNO**TERMO**

Aqua.com

corbellini
FERRAMENTA E IDRAULICA SRL

Ferro - Ferramenta - Edilizia - Idraulica
arturo mancini
Cento Anni di Ferro

Rinaldo
Tomasella
group

CAIVIT
Termoidraulica

**COI
MA**
srl

Stema

pattono
BATHROOM & SURFACES 1882

**idromarket
laveno**

IDROFORNITURE

ACQUA PROGETTI

idroplast srl

IDROSANITARIA

THERMO IGIENICA

A B C D
Antincendio Bruciatori Condizionatori Caldaie Depuratori

BP TERMITALIA s.r.l.

C+
CEMI
POWER-UP

Cieffe di Capelli
MATERIALE
IDROTERMOSANITARIO
& ARREDOBAGNO

esseci

DI LEONE

FOTIR

aqua
plant
System

ceriale

TERZO

DeLo'

www.deloitalia.com

delfino

NOTE

I dati, le misure, gli articoli, i prezzi, le caratteristiche tecniche e tutti gli altri dati riportati nel nostro listino hanno carattere indicativo. Possono essere variati senza nessun preavviso. Hanno valore vincolante unicamente in caso di espressa indicazione nell'accettazione dell'ordine o nella conferma d'ordine. I prezzi sono IVA esclusa.

delfino
DOVE SIAMO



Associato di zona:

Delò
Delfino Società Cooperativa
Via Anna Magnani, 7 A/B/C - 40051
Altedo - Bologna - Italy
Tel. 051-6601281 - Fax 051-9711140
info@deloitalia.com

www.deloitalia.com - www.delfino.it

Il Gruppo Delfino, proprietario del brand **Delò®**, è anche **Corporate Golden Donor del FAI - Fondo Ambiente Italiano.**

